

EDS4900U-REG
00408862

Lenze

Manual

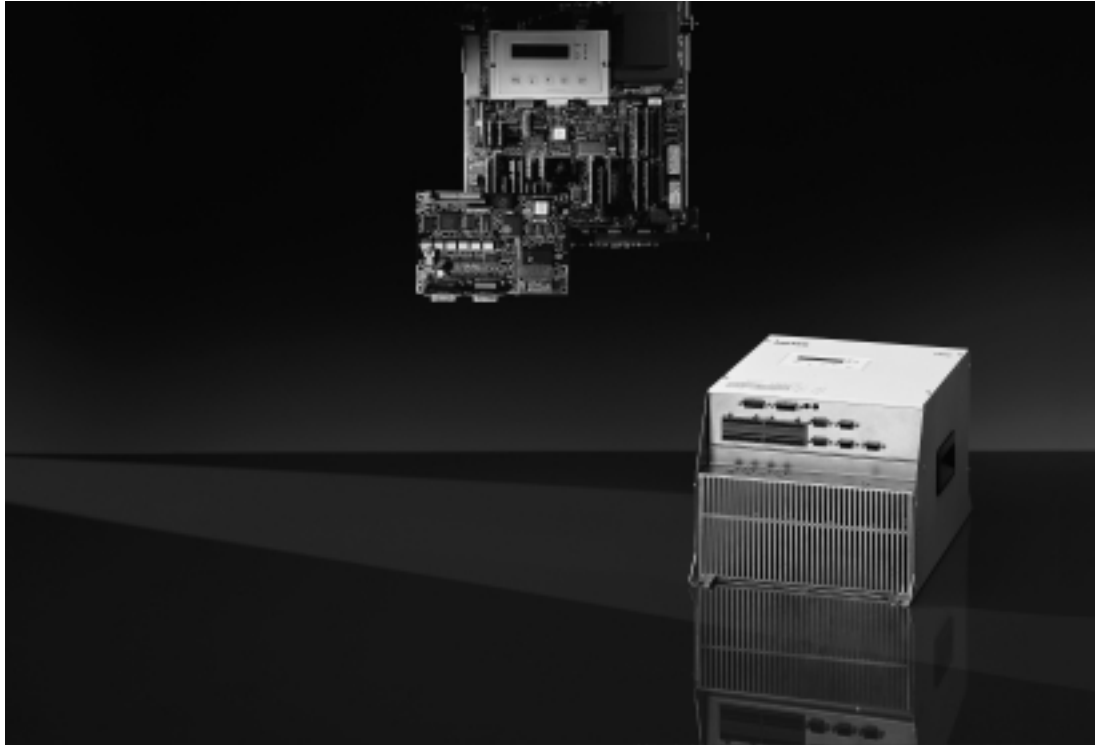

DC speed controller 4800/4900

*Table of contents
Preface and general
information
Safety information*

*Technical data
Installation*

*Commissioning
During operation*

*Configuration
Code table*

*Troubleshooting and
fault elimination
Maintenance*

DC bus connection

Application of brake units

Automation

Accessories and motors

*Selection aid
Application examples*

Signal-flow charts

*Glossary
Table of keywords*

Manual 4800 / 4900		
Part	Content	Notes
A	Table of contents Preface and general information Safety information	●
B	Technical data Installation	●
C	Commissioning During operation	●
D	Configuration Code table	●
E	Troubleshooting and fault elimination Maintenance	●
F	DC bus connection	
G	Application of brake units	
H	Automation	●
I	Accessories and motors	●
K	Selection aid Application examples	●
L	Signal-flow charts	●
M	Glossary Table of keywords	●

Explanation: ● in the Manual.

All documentation indicated have a material number and the type code in the left upper corner of the cover page.
In part M there is a list with these data.

The controller's features and data indicated in this Manual are at the state-of-art at the time of print. (The print data is indicated on the inner cover page of each of part.)

Lenze endeavours to regularly update all documentation to the current technical state. If you should find any deviations, please refer to the Operating Instructions, which are part of the delivery package, or to your nearest Lenze representative.

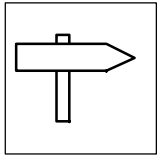

Part A

1	Preface and general information	1-1
1.1	About these Operating Instructions	1-1
1.1.1	Terminology used	1-1
1.2	Scope of delivery	1-1
1.3	48XX/49XX controller	1-2
1.3.1	Labelling	1-2
1.3.2	Application as directed	1-2
1.3.3	Legal regulations	1-3
1.4	EC Directives/Declaration of Conformity	1-4
1.4.1	What is the purpose of EC directives?	1-4
1.4.2	What does the CE mark imply?	1-4
1.4.3	EC Low-Voltage Directive	1-4
1.4.4	EC Directive Electromagnetic Compatibility	1-6
1.4.5	EC Machinery Directive	1-9
2	Safety information	2-1
2.1	Persons responsible for the safety	2-2
2.2	General safety information	2-3
2.3	Residual hazards	2-3
2.4	Layout of the safety information	2-4

Part B

3	Technical data	3-1
3.1	Features	3-1
3.2	General data / application conditions	3-3
3.3	Rated data	3-4
3.3.1	Mains voltage 400V	3-4
3.3.2	Mains voltage 500V (Variant V014)	3-6
3.4	Dimensions	3-8
3.4.1	Controller 4902 to 4X09	3-8
3.4.2	Controllers 4811 to 4813, 4911 to 4913	3-9
4	Installation	4-1
4.1	Mechanical installation	4-1
4.1.1	Important notes	4-1
4.2	Electrical installation	4-2
4.2.1	Protection of persons	4-2
4.2.2	Protection of the controller	4-3
4.2.3	Screening of the control cables	4-3
4.2.4	Earthing of the control electronics	4-4
4.2.5	Mains types and conditions	4-4

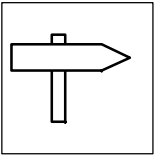

Contents

4.3	Connection	4-5
4.3.1	Power connection of standard controller	4-6
4.3.2	Separate supply of the field-current bridge at a high motor field voltage	4-9
4.3.3	Separate supply for the control electronics	4-11
4.3.4	Control connections	4-13
4.3.4.1	Connection of analog signals	4-14
4.3.4.2	Connection of digital signals	4-17
4.3.5	Feedback systems	4-21
4.3.6	Change of the direction of rotation in 2Q operation	4-23
4.3.7	Digital frequency selection and encoder emulation	4-24
4.3.8	Serial interface RS232/485	4-26
4.3.9	Fieldbus connection	4-27
4.4	Installation of a CE-typical drive system	4-29
4.4.1	General notes	4-29
4.4.2	Components of the CE-typical drive system	4-30
4.4.3	Measures required	4-30

Part C

5	Commissioning	5-1
5.1	Initial switch-on	5-1
5.2	Commissioning of speed-controlled drives	5-2
5.2.1	Wiring recommendation for speed control with tacho	5-3
5.2.2	Wiring recommendation for speed control with resolver	5-4
5.2.3	Speed control with armature voltage feedback	5-5
5.3	Commissioning of torque-controlled drives	5-6
5.3.1	Wiring recommendation for torque control with speed limitation	5-7
5.4	Input of the motor data	5-8
5.5	Controller enable	5-9
5.6	Selection of direction of rotation and quick stop	5-10
5.7	Changing the internal control structure	5-12
5.8	Changing the terminal assignment	5-12
6	During operation¹⁾	

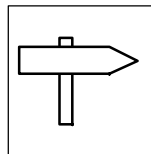

Part D

7	Configuration	7-1
7.1	Speed-controlled operation	7-1
7.1.1	Setpoint selection	7-1
7.1.1.1	Main setpoint	7-2
7.1.1.2	Additional setpoint	7-2
7.1.1.3	JOG setpoints	7-2
7.1.1.4	Master current	7-4
7.1.1.5	External torque reduction	7-4
7.1.1.6	Acceleration and deceleration times T_{ir} , T_{if}	7-6
7.1.1.7	Limitation of the speed setpoint	7-9
7.1.2	Actual value feedback	7-10
7.1.2.1	Armature voltage feedback	7-10
7.1.2.2	DC tacho feedback	7-11
7.1.2.3	Resolver feedback	7-13
7.1.2.4	Incremental encoder feedback	7-13
7.1.3	Freely assignable inputs and outputs	7-14
7.1.3.1	Freely assignable digital inputs (FDI)	7-14
7.1.3.2	Freely assignable digital outputs (FDO)	7-16
7.1.3.3	Frei belegbare "analoge" Eingänge (FAE)	7-21
7.1.3.4	Freely assignable monitor outputs	7-25
7.2	Torque control with speed limitation	7-29
7.3	Digital frequency coupling	7-31
7.3.1	Master	7-32
7.3.2	Slave for digital frequency bar	7-34
7.3.3	Slave for digital frequency cascade	7-38
7.3.4	Digital frequency output	7-43
7.3.5	Speed synchronism	7-44
7.3.5.1	Speed-synchronous running	7-44
7.3.5.2	Speed ratio synchronism	7-44
7.3.6	Phase synchronisation	7-45
7.3.6.1	Phase controller	7-46
7.3.6.2	Phase trimming	7-47
7.3.6.3	Following error limit	7-47
7.4	Additional control functions	7-48
7.4.1	Redundant actual value feedback	7-48
7.4.2	Changeable parameter sets	7-50
7.4.3	4Q / 2Q changeover	7-53
7.4.4	Standstill excitation (field heating)	7-54
7.4.5	Control of a holding brake	7-55
7.4.5.1	Engage brake	7-57
7.4.5.2	Open brake (release)	7-58
7.5	Additional function blocks	7-60
7.5.1	Process controller	7-60
7.5.2	Arithmetic blocks	7-63
7.5.3	Motor potentiometer	7-66
7.5.3.1	Control of the motor potentiometer	7-67
7.5.3.2	Memory function of the motor potentiometer (S&H)	7-68
7.5.4	Fixed set-value	7-70

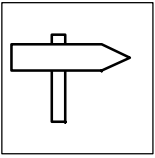

Contents

7.5.5	Absolute value generator	7-71
7.5.6	Limitation elements	7-72
7.5.7	PT1 element	7-73
7.5.8	Addition	7-74
7.5.9	Square-wave generator	7-76
7.5.10	Dead-band element	7-77
7.5.11	DT1 element	7-78
7.5.12	Freely assignable comparator	7-79
7.6	Additional control functions	7-82
7.6.1	Additional torque values	7-82
7.6.2	Speed dependent armature current limitation	7-83
7.6.3	n controller adaptation	7-86
7.6.4	S-shaped ramp function generator characteristic	7-87
7.6.5	Actual speed filter	7-87
7.6.6	Excitation characteristic	7-88
7.7	Monitoring	7-90
7.7.1	Change of the monitoring functions	7-90
7.7.2	Overload monitoring for the controller (I _{Vt} monitoring)	7-94
7.7.3	Overload monitoring for the motor (I _{2Vt} monitoring)	7-95
7.7.4	Blocking protection for the motor	7-97
7.7.5	Mains monitoring	7-99
7.7.6	Monitoring of the serial interface	7-101
7.8	Parameter setting	7-102
7.8.1	Ways of parameter setting	7-102
7.8.2	Functions of the operation unit	7-103
7.8.3	Operating modes	7-104
7.8.4	Display functions	7-105
7.9	Code table	7-107
7.10	Table of attributes	7-133

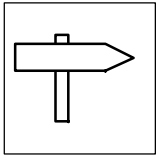

Part E

8	Troubleshooting and fault elimination	8-1
8.1	Troubleshooting	8-1
8.1.1	Display on the operating unit of the controller	8-1
8.1.2	Display via LECOM	8-2
8.2	Fault analysis with the history buffer	8-3
8.2.1	Structure of the history buffer	8-3
8.3	Fault messages	8-4
8.4	Reset of fault indications	8-6
8.5	Checking the drive system	8-7
8.5.1	Checking the motor	8-7
8.5.2	Checking the controller	8-8
9	Maintenance	9-1
9.1	Maintenance	9-1
9.2	Service addresses	9-1

Part F

10 DC-bus operation¹⁾

Part G

11 Application of brake units¹⁾

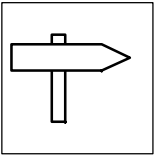

Contents

Part H

12 Automation	12-1
12.1 LECOM1 interface	12-1
12.2 LECOM2 interface (option)	12-1
12.3 LECOM code number	12-1
12.4 Enable LECOM interface	12-3
12.4.1 Process data and parameter channel	12-3
12.4.2 High precision set and actual values	12-5

Part I

13 Accessories	13-1
13.1 Fuses	13-2
13.1.1 Mains fuses	13-3
13.1.2 Armature fuses	13-4
13.1.3 Internal fuses	13-5
13.1.4 Fuse holder	13-5
13.2 Mains chokes	13-7
13.2.1 Mains chokes for power connection	13-7
13.2.2 Mains choke for separate supply of the field bridge	13-8
13.3 Pre-assembled Lenze system cable	13-10
13.3.1 Resolver connection cable	13-10
13.3.2 Incremental encoder connection cable	13-11
13.3.3 System cable for digital frequency coupling	13-11
13.4 RFI filter	13-12
13.4.1 RFI filter for power connection	13-12
13.4.2 RFI filter for fan supply	13-14
13.5 Networking accessories	13-15
13.5.1 Connection elements for optical fibres	13-15
13.5.2 Level converter	13-15

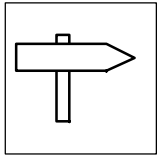

Part K

14 Selection aid	14-1
14.1 Assignment of controller and motor	14-1
14.1.1 Selection criteria	14-1
14.1.2 Armature choke	14-3
15 Application examples	15-1
15.1 Speed control with armature-voltage feedback	15-2
15.2 Speed control with resolver	15-4
15.3 Torque control with speed limitation	15-6
15.4 Current-ratio control	15-8
15.5 Dancer-position control at an unwinder	15-10
15.6 Hoists	15-13
15.7 Speed-ratio synchronism	15-15
15.8 Modular box 2215	15-18
15.8.1 Winding drive	15-18
15.8.2 Positioning drive	15-20
15.9 Mains isolation	15-23
15.9.1 Tipping with mains isolation	15-23
15.9.2 Mains switch-off logic	15-25

Part L

16 Signal-flow charts	16-1
------------------------------------	-------------

Part M

17 Glossary	17-1
18 Index	18-1

- 1) **This chapter is part of the Lenze documentation structure. It remains free for the 48XX/49XX DC speed controller.**

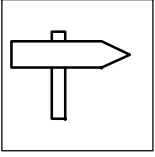

Contents

EDS4900U--A
00408849

Manual Part A

Contents

Preface and general information

Safety information

***DC speed controller
4800/4900***

The features, data and versions indicated in this Manual met the state of the art at the time of printing.

(Printing date: inner cover pages of the parts).

In the event of deviations, please see the Operating Instructions or contact Lenze.

		revised	
Edition of:	01/03/1999		

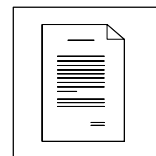

1 Preface and general information

1.1 About these Operating Instructions ...

- These Operating Instructions are intended for safety-relevant operations on and with the 48XX/49XX DC controllers. They contain safety information which must be observed.
- All persons who work on and with 48XX/49XX DC controllers must have the Operating Instructions available and observe all relevant notes and instructions.
- The Operating Instructions must always be in a complete and perfectly readable state.

1.1.1 Terminology used

Controller

In the following, the term "controller" is used for "48XX/49XX DC controllers".

Drive system

In the following text, the term "drive system" is used for drive systems with 48XX/49XX DC controllers and other Lenze drive components.

1.2 Scope of delivery

- The scope of delivery includes:
 - 1 48XX/49XX DC controller
 - 1 Operating Instructions
 - 1 Accessory kit with plug-in terminals
- After receipt of the delivery, check immediately whether the scope of delivery matches the accompanying papers. Lenze does not accept any liability for deficiencies claimed subsequently. Make a claim for
 - visible transport damage immediately to the forwarder.
 - visible deficiencies/incompleteness immediately to your Lenze representative.



Preface and general information

1.3 48XX/49XX controller

1.3.1 Labelling

- Lenze 48XX/49XX controllers are unambiguously designated by the contents of the nameplate.
- CE mark:
 - Conformity with the Low-Voltage Directive
 - Conformity with the EMC Directive
- Manufacturer
 - Lenze GmbH & Co KG
 - Postfach 101352
 - D-31763 Hameln

1.3.2 Application as directed

48XX/49XX controllers

- must only be operated under the conditions prescribed in these Instructions.
- are components
 - for open-loop and closed-loop control of variable speed drives with separately excited DC motors.
 - to be installed into a machine.
 - used for assemblies together with other components to form a machine.
- should not be driven together with other DC motors, such as shunt motors or separately excited motors with a stabilizing series winding, before you have contacted Lenze.
- are electric units for the installation into control cabinets or similar enclosed operating housings.
- are not to be used as domestic appliances, but only for industrial purposes.

Drive systems with 48XX/49XX controllers

- comply with the EMC Directive, if they are installed according to the guidelines for CE-typical drive systems.
- can be used
 - on public and non-public mains.
 - in industrial premises.

The user is responsible for the compliance of his application with the EC directives.

Any other use shall be deemed inappropriate!

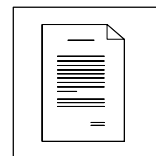

1.3.3 Legal regulations

Liability

- The information, data and notes in these Operating Instructions met the state-of-the-art at the time of printing. Claims referring to drive systems which have already been supplied cannot be derived from the information, illustrations, and descriptions.
- The specifications, processes, and circuitry described in these Operating Instructions are for guidance only and must be adapted to your own specific application. Lenze does not take responsibility for the suitability of the process and circuit proposals.
- The indications given in these Operating Instructions describe the features of the product without warranting them.
- Lenze does not accept any liability for damage and operating interference caused by:
 - disregarding these Operating Instructions
 - unauthorized modifications to the controller
 - operating errors
 - improper working on and with the controller

Warranty

- Terms of warranty: see terms of sale and delivery of Lenze GmbH & Co KG.
- Warranty claims must be made immediately after detecting defects or faults.
- The warranty is void in all cases where liability claims cannot be made.

Disposal

The controller consists of different materials.

The following table lists which materials can be recycled and which must be disposed of.

Material	recycle	dispose
Metal	•	-
Plastic	•	-
Printed-board assemblies	-	•



1.4 EC Directives/Declaration of Conformity

1.4.1 What is the purpose of EC directives?

EC directives are issued by the European Council and are intended for the determination of common technical requirements (harmonization) and certification procedures within the European Community. At the moment, there are 21 EC directives for product ranges. The directives are or will be converted to national laws of the member states. A certification issued by one member state is automatically valid without any further approval in all other member states.

The texts of the directive are restricted to the essential requirements. Technical details are or will be determined by European harmonized standards.

1.4.2 What does the CE mark imply?

After a verification, the conformity according to the EC directives is certified by affixing a CE mark. Within the EC there are no commercial barriers for a product with the CE mark.

Controllers on their own with the CE mark correspond exclusively to the Low Voltage Directive. For the compliance with the EMC Directive, only general recommendations have been issued so far. The CE conformity of the installed machine remains the responsibility of the user. For the installation of CE-typical drive systems with the basic version of 48XX/49XX controllers and the variants V011, V013 and V014, Lenze has already proved the conformity with the EMC Directive (see chapter 4.4).

1.4.3 EC Low-Voltage Directive

(73/23/EEC)

amended by: CE Mark Directive (93/68/EEC)

General

- The Low-Voltage Directive is effective for all electrical equipment for use with a rated voltage between 50 V and 1000 V AC and between 75 V and 1500 V DC, and under normal ambient conditions. The use, for instance, of electrical equipment in explosive atmospheres and electrical parts in passenger and goods lifts are excepted.
- The objective of the Low-Voltage Directive is to ensure that only electrical equipment which does not endanger the safety of persons or animals is placed on the market. It should also be designed to conserve material assets.

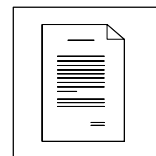

EC Declaration of Conformity '99

for the purpose of the EC Low Voltage Directive (73/23/EEC)

amended by: CE Mark Directive (93/68/EEC)

48XX/49XX controllers were developed, designed, and manufactured in compliance with the EC Directive under the sole responsibility of

Lenze GmbH & Co KG, Postfach 10 13 52, D-31763 Hameln

Considered standards:

Standard	
DIN EN 50178 Classification VDE 0160 / 04.98	Electronic equipment for use in electrical power installations
DIN VDE 0100	Standards for the erection of power installations
EN 60529	IP degrees of protection
IEC 249 / 1 10/86, IEC 249 / 2-15 / 12/89	Base material for printed circuits
IEC 326 / 1 10/90, EN 60097 / 9.93	Printed circuits, printed boards
DIN VDE 0110 /1-2 /1/89 /20/ 8/90	Creepage distances and clearances

Hameln, 01/03/1999

_____ (i. V. Schäfer) Product Manager	_____ (i. A. Tolksdorf) Commissioned for CE
---	---



1.4.4 EC Directive Electromagnetic Compatibility

(89/336/EEC)

amended by: First Amendment Directive (92/31/EEC)

CE Mark Directive (93/68/EEC)

General

- The EC Electromagnetic Compatibility Directive is effective for "devices" which may cause electromagnetic interference, or the operation of which may be impaired by such interference.
- The aim is to limit the generation of electromagnetic interference so that an operation is possible without interference to radio and telecommunication systems and other equipment. The devices must also show an appropriate resistance to electromagnetic interference, to ensure the application as directed.
- Controllers cannot be evaluated on their own in terms of EMC. Only after the integration of the controllers into a drive system, can this system be tested concerning the objectives of the EC EMC Directive and the compliance with the "Law about the Electromagnetic Compatibility of Devices".
- Lenze has verified the conformity of 48XX/49XX controllers integrated into certain defined drive systems. In the following, these systems are called "CE-typical drive systems" (see chapter 4.4).
- The following configurations can now be selected by the user:
 - The user himself can determine the system components and their integration into the drive system, and is then held responsible for the conformity of the drive.
 - The user can select the CE-typical drive systems for which the manufacturer has already proved the conformity.

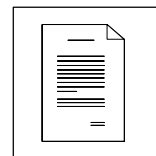

EC Declaration of Conformity '97 for the purpose of the EC Directive

on Electromagnetic compatibility (89/336/EEC)

amended by: First Amendment Directive (92/31/EEC)

CE Mark Directive (93/68/EEC)

48XX/49XX controllers cannot be driven in stand-alone operation for the purposes of the Regulation on Electromagnetic Compatibility (EMVG of 09 November, 1992 and the first Amendment of 08 August, 1995). The EMC can only be verified when the controller is integrated into a drive system.

Lenze GmbH & Co KG, Postfach 10 13 52, D-31763 Hameln

declares that the described "CE-typical drive systems" with the basic version of 48XX/49XX controller and the variants V011, V013 and V014 comply with the above EC Directive.

The conformity evaluation is based on the product standard for drive systems EN 61800-3.

EN 61800-3	EMC product standard including special test methods for electric drives
------------	---

Generic standards considered:

Generic standard	
EN 50081-2 /93	Generic standard for noise emission; part 2: Industrial premises The noise emission in industrial premises is not limited in EN 61800-3. These generic standards are used in addition to the requirements of the standard DIN IEC 22G.
EN 50082-2 3/94	Generic standard for noise immunity part 2: Industrial premises (The requirements of noise immunity for residential areas were not considered, since these are less strict.)

Generic standards considered for the test of noise emission:

Generic standard	Test	Limit value
EN 55011 7/92	Radio interferences, housing and mains Frequency range 0.15 - 1000MHz The noise emission in industrial premises is not limited in EN 61800-3. These generic standards are used in addition to the requirements of EN 61800-3.	Class A for use in industrial premises



Preface and general information

Generic standards considered for the test of noise emission:

Basic standard		Test	Limit value
EN 61000-4-2	3/95	Electrostatic discharge on housing and heatsink	Severity 3 6kV for contact, 8kV clearance
IEC 1000-4-3	2/95	Electromagnetic fields Frequency range 26-1000MHz	Severity 3 10V/m
ENV 50140	8/93	High-frequency field Frequency range 80-1000MHz, 80% amplitude modulated	Severity 3 10V/m
		Fixed frequency 900MHz with 200Hz, 100 % modulated	10V/m
EN 61000-4-4	3/95	Fast transients, burst on power terminals	Severity 3 2kV/5kHz
		Burst on bus and control cables	Severity 4 2kV/5kHz
EN 61000-4-5	10/94	Surge test Mains cable	Installation class 3

Hameln, 01/03/1999

<hr/> (i. V. Schäfer) Product Manager	<hr/> (i. A. Tolksdorf) Commissioned for CE
---	---

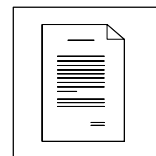

1.4.5 EC Machinery Directive

(89/392/EEC)

amended by: First Amendment Directive (91/368/EEC)

Second Amendment Directive (93/44/EEC)

CE Mark Directive (93/68/EEC)

For the purpose of the Machinery Directive, "machinery" means an assembly of linked parts or components, at least one of which can move, with the appropriate actuators, control and power circuits, etc., joined together for a specific application, in particular for the processing, treatment, moving or packaging of a material.

EC Manufacturer's Declaration

for the purpose of the EC Machinery Directive (89/392/EEC)

amended by: First Amendment Directive (91/368/EEC)

Second Amendment Directive (93/44/EEC)

CE Mark Directive (93/68/EEC)

48XX/49XX controllers were developed, designed, and manufactured under the sole responsibility of

Lenze GmbH & Co KG, Postfach 10 13 52, D-31763 Hameln

Commissioning of the controllers is prohibited until it is proven that the machine in which they are to be installed corresponds to the EC Machinery Directive.

Hameln, 01/03/1999

(i. V. Schäfer)
Product Manager



Preface and general information



2 Safety information



Safety and application notes for controllers

(to: Low-Voltage Directive 73/23/EEC)

1. General

During operation, drive controllers may have, according to their type of protection, live, bare, in some cases also movable or rotating parts as well as hot surfaces.

Non-authorized removal of the required cover, inappropriate use, incorrect installation or operation, creates the risk of severe injury to persons or damage to material assets.

Further information can be obtained from the documentation.

All operations concerning transport, installation, and commissioning as well as maintenance must be carried out by qualified, skilled personnel (IEC 364 and CENELEC HD 384 or DIN VDE 0100 and IEC report 664 or DIN VDE 0110 and national regulations for the prevention of accidents must be observed).

According to this basic safety information qualified skilled personnel are persons who are familiar with the erection, assembly, commissioning, and operation of the product and who have the qualifications necessary for their occupation.

2. Application as directed

Drive controllers are components which are designed for installation in electrical systems or machinery.

When installing in machines, commissioning of the drive controllers (i.e. the starting of operation as directed) is prohibited until it is proven that the machine corresponds to the regulations of the EC Directive 89/392/EEC (Machinery Directive); EN 60204 must be observed.

Commissioning (i.e. starting of operation as directed) is only allowed when there is compliance with the EMC Directive (89/336/EEC).

The drive controllers meet the requirements of the Low Voltage Directive 73/23/EEC. The harmonized standards of the prEN 50178/ DIN VDE 0160 series together with EN 60439-1/DIN VDE 0660 part 500 and EN 60146/DIN VDE 0558 are applicable to drive controllers.

The technical data and information on the connection conditions must be obtained from the nameplate and the documentation and must be observed in all cases.

3. Transport, storage

Notes on transport, storage and appropriate handling must be observed.

Climatic conditions must be observed according to prEN 50178.

4. Erection

The devices must be erected and cooled according to the regulations of the corresponding documentation.

The drive controllers must be protected from inappropriate loads. Particularly during transport and handling, components must not be bent and/or isolating distances must not be changed. Touching of electronic components and contacts must be avoided.

Drive controllers contain electrostatically sensitive components which can easily be damaged by inappropriate handling. Electrical components must not be damaged or destroyed mechanically (health risks are possible!).

5. Electrical connection

When working on live drive controllers, the valid national regulations for the prevention of accidents (e.g. VBG 4) must be observed.

The electrical installation must be carried out according to the appropriate regulations (e.g. cable cross-sections, fuses, PE connection). More detailed information is included in the documentation.

Notes concerning the installation in compliance with EMC - such as screening, grounding, arrangement of filters and laying of cables - are included in the documentation of the drive controllers. These notes must also be observed in all cases for drive controllers with the CE mark. The compliance with the required limit values demanded by the EMC legislation is the responsibility of the manufacturer of the system or machine.

6. Operation

Systems where drive controllers are installed must be equipped, if necessary, with additional monitoring and protective devices according to the valid safety regulations, e.g. law on technical tools, regulations for the prevention of accidents, etc. Modifications of the drive controllers by the operating software are allowed.

After disconnecting the drive controllers from the supply voltage, live parts of the controller and power connections must not be touched immediately, because of possibly charged capacitors. For this, observe the corresponding labels on the drive controllers.

During operation, all covers and doors must be closed.

7. Maintenance and servicing

The manufacturer's documentation must be observed.

The safety information must be preserved!

The product-specific safety and application notes in these Operating Instructions must also be observed!



Safety information

2.1 Persons responsible for the safety

Operator

- An operator is any natural or legal person who uses the drive system or on behalf of whom the drive system is used.
- The operator or his safety officer are obliged to ensure that
 - all relevant regulations, notes and laws are observed
 - only qualified personnel work on and with the drive system.
 - the personnel have the Operating Instructions available for all corresponding operations and
 - unqualified personnel are prohibited from working with and on the controller.

Qualified personnel

Qualified personnel are persons who - because of their education, experience, instruction, and knowledge about corresponding standards and regulations, rules for the prevention of accidents, and operating conditions - are authorized by the person responsible for the safety of the plant to perform the required actions and who are able to recognize and avoid potential hazards.
(see IEC 364, definition of qualified personnel)



2.2 General safety information

- These safety notes do not claim to be complete. In case of questions and problems please contact your Lenze representative.
- At the time of supply the drive system is state-of-the-art and ensures basically safe operation.
- The indications given in these Operating Instructions refer to the stated hardware and software versions of the controller.
- The controller is hazardous to persons, the controller itself and other property of the operator, if
 - unqualified personnel work on and with the drive system.
 - the controller is used inappropriately.
- The specifications, processes, and circuitry described in these Operating Instructions are for guidance only and must be adapted to your own specific application.
- Controllers must be designed so that they comply with their function and do not cause any hazards to persons, when correctly installed and in fault-free operation as directed. This also applies to the whole system.
- Take additional measures to limit consequences of malfunctions which may cause hazards to personnel or damage to properties:
 - further independent equipment which can take over the function of the controller
 - electrical or non-electrical protection (latching or mechanical blocking)
 - measures covering the complete system
- The drive system must only be operated in perfect condition.
- Retrofittings, modifications, or changes are generally prohibited. For some applications, Lenze authorizes the operation of retrofitted, modified or changed controllers. Please contact Lenze.

2.3 Residual hazards

Excessive speed

Drive systems may reach dangerously high speeds (e.g. caused by active loads like hoists):

- 48XX/49XX controllers do not offer any protection against these operating conditions. Use additional components for this.



Safety information

2.4 Layout of the safety information

- All safety information given in these Operating Instructions has the same layout:



Signal word

Note

- The icon characterizes the type of danger.
- The signal word characterizes the severity of danger.
- The note describes the danger and suggests how to avoid the danger.

Warning of danger for persons

Icons used		Signal words	
	Warning of hazardous electrical voltage	Danger!	Warns of impending danger . Consequences if disregarded: Death or very severe injuries.
		Warning!	Warns of potential, very hazardous situations . Possible consequences if disregarded: Death or very severe injuries.
	Warning of a general danger	Caution!	Warns of potential, hazardous situations . Possible consequences if disregarded: Light or minor injuries.

Warning of damage to material

Icons used		Signal words	
		Stop!	Warns of potential damage to material . Possible consequences if disregarded: Damage to the controller/drive system or its environment.

Other notes

Icons used		Signal words	
		Note!	Designates a general, useful tip. If you observe it, handling of the controller/drive system is made easier.

EDS4900U--B
00408850

Manual

Part B

Technical Data

Installation

DC speed controller
4800/4900

The features, data and versions indicated in this Manual met the state of the art at the time of printing.

(Printing date: inner cover pages of the parts).

In the event of deviations, please see the Operating Instructions or contact Lenze.

		revised	
Edition of:	01/03/1999		

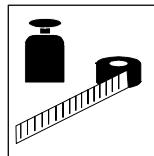

3 Technical data

3.1 Features

Controller and system features

- Control electronics and system software are the same for 48XX/49XX
- Digital speed feedback with resolver or incremental encoder
- Torque control with superimposed speed monitoring for winding drives
- Phase control for drift-free positioning
- Digital frequency coupling as setpoint bar or setpoint cascade for
 - phase synchronisation
 - speed-synchronous operation
 - synchronous speed ratio
- Increase of the max. armature voltage to $115\% \cdot V_{\text{mains}}$ by changing from 4Q to 2Q operation (with 49XX)
- Speed accuracy better than 0.5‰ at 100% changing load with resolver feedback or incremental encoder
- Speed setting range 1:1000 at constant load with resolver feedback or incremental encoder
- Current setting range 1:300 by means of pulse current adaptation and bridge modulation
- Speed-dependent armature current limitation
- Adjustable max. armature current from 112,5 % to 180 % rated current (depending on the size)
- Freely connectable process controller, e.g. for dancer position control or tension control
- Integrated field current control for large speed setting range
- 4 customer-specific parameter sets can be saved and changed via digital input terminals

Operation

- On-line changes of control parameters
- Parameter setting and diagnosis via
 - keypad with two-line LCD in German, Englisch and French
 - serial interface and PC
 - fieldbus module (as option): PROFIBUS, InterBus
- Fault messages plain text

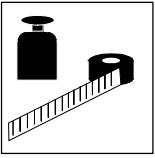

Technical Data

Speed feedback systems

- Resolver feedback with encoder emulation for superimposed systems (synchronizing systems, positioning controls, etc.)
- Incremental encoder feedback
- DC tacho feedback
- Armature voltage feedback

Inputs

- **Digital**
 - 8 isolated inputs (24 V level), 5 of them freely assignable
 - 1 serial interface RS 485 or RS 232 (1200 ... 9600 baud)
- **Analog**
 - 4 freely assignable inputs (13 bit resolution)
e.g. for main setpoint, additional setpoint, torque limitation, etc.

Outputs

- **Digital**
 - 8 isolated outputs (24 V level), 5 of them freely assignable
 - Another 7 free outputs can be evaluated via the LECOM interface
 - 1 relay output (50V; 0,5A), freely assignable
- **Analog**
 - 2 reference voltages (10V, 7mA)
 - 1 monitor output, with I_{act}
 - 2 monitor outputs, freely assignable (37 different signals with 11 bit resolution selectable)
 - 1 frequency output, freely assignable

Monitoring

- Monitoring functions of the system and controller components
- Controller protection ($I \cdot t$ function)
- Motor overload protection ($I^2 \cdot t$ function)
- Monitoring of frequency and mains voltage
- Self-synchronisation for mains frequencies from 50 to 60Hz
- Safe operation with CW or CCW direction of rotating field input
- Monitoring of the act.-value encoder feedback
- Display of the sources of controller inhibit via a code
- Classifiable monitoring (TRIP, message or warning)
- Monitoring of the cooling air stream with 4X08 to 4X13
- Monitoring of the semiconductor fuses with 4X11 to 4X13

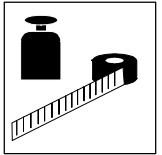

3.2 General data / application conditions

Field	Values															
Type of protection	IP20 to DIN 40050, steel sheet housing															
Permissible humidity	Relative humidity 90%, no condensation															
Temperature ranges	<table> <tr> <td>Storage</td> <td>-25 C...+ 55 C</td> </tr> <tr> <td>Transport</td> <td>-25 C...+ 70 C</td> </tr> </table>	Storage	-25 C...+ 55 C	Transport	-25 C...+ 70 C											
Storage	-25 C...+ 55 C															
Transport	-25 C...+ 70 C															
Influence of the installation height	<table> <tr> <td>h ≤ 1000m</td> <td>: 100% rated armature current</td> </tr> <tr> <td>h ≤ 2000m</td> <td>: 95% rated armature current</td> </tr> <tr> <td>h ≤ 3000m</td> <td>: 90% rated armature current</td> </tr> <tr> <td>h ≤ 4000m</td> <td>: 85% rated armature current</td> </tr> </table>	h ≤ 1000m	: 100% rated armature current	h ≤ 2000m	: 95% rated armature current	h ≤ 3000m	: 90% rated armature current	h ≤ 4000m	: 85% rated armature current							
h ≤ 1000m	: 100% rated armature current															
h ≤ 2000m	: 95% rated armature current															
h ≤ 3000m	: 90% rated armature current															
h ≤ 4000m	: 85% rated armature current															
Degree of pollution	VDE 0110, part 2, degree of pollution 2 Controllers must not be exposed to a corrosive or explosive atmo-sphere.															
Noise emission	Requirements to EN 50081-2, IEC 22G Limit-value class A (EN 55011; industrial premises) with RFI filter															
Noise immunity	<p>Limit values maintained with RFI filter. Requirements to EN 50082-2, IEC 22G</p> <table> <thead> <tr> <th>Requirements</th> <th>Standard</th> <th>Severity</th> </tr> </thead> <tbody> <tr> <td>ESD</td> <td>EN 61000-4-2</td> <td>3, i.e. 8kV air discharge 6 kV contact discharge</td> </tr> <tr> <td>RF interference (enclosure)</td> <td>IEC 1000-4-3</td> <td>3, i.e. 10 V/m</td> </tr> <tr> <td>Burst</td> <td>EN 61000-4-4</td> <td>3/4, i.e. 2kV / 5kHz</td> </tr> <tr> <td>Surge</td> <td>EN 61000-4-5</td> <td>3, i.e. 1.2 / 50µs 1kV phase - phase 2kV phase - PE</td> </tr> </tbody> </table>	Requirements	Standard	Severity	ESD	EN 61000-4-2	3, i.e. 8kV air discharge 6 kV contact discharge	RF interference (enclosure)	IEC 1000-4-3	3, i.e. 10 V/m	Burst	EN 61000-4-4	3/4, i.e. 2kV / 5kHz	Surge	EN 61000-4-5	3, i.e. 1.2 / 50µs 1kV phase - phase 2kV phase - PE
Requirements	Standard	Severity														
ESD	EN 61000-4-2	3, i.e. 8kV air discharge 6 kV contact discharge														
RF interference (enclosure)	IEC 1000-4-3	3, i.e. 10 V/m														
Burst	EN 61000-4-4	3/4, i.e. 2kV / 5kHz														
Surge	EN 61000-4-5	3, i.e. 1.2 / 50µs 1kV phase - phase 2kV phase - PE														

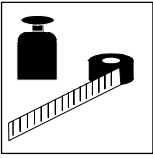

Technical Data

3.3 Rated data

3.3.1 Mains voltage 400V

- Controllers 4902 to 4907 (4Q controllers)

	Type	4902	4903	4904	4905	4906	4907
	Order No.	EVD 4902-E	EVD 4903-E	EVD 4904-E	EVD 4905-E	EVD 4906-E	EVD 4907-E
Output power ¹⁾	P _{el} [kW]	6.7	10.5	23.1	46.2	84	105
Mains voltage	V _{mains}	3 340...460 V~ ± 0%, 50...60Hz					
Armature voltage	V _A	420V if V _{mains} = 400V (1.05 V _{mains})					
Rated armature current (continuous operation)	I _{Arated} [A]	16	25	55	110	200	250
Maximum current (short-time operation)	I _{Amax} [A]	29	45	90	150	240	300
Field voltage ²⁾	V _F	V _{Fmax} = 0.875 V _{L1-L3}					
Max. field current, controlled	I _F [A]	3.5			10		
Power loss ³⁾	P _{loss} [W]	60	108	185	288	577	650
Ambient temperature in operation	T _{amb} [°C]	0...+ 45					
Weight approx.	[kg]	9,2	13,1	13,8	18	22	23

- Controllers 4908 to 4913 (4Q controllers)

	Type	4908	4909	4911	4912	4913
	Order No.	EVD 4908-E	EVD 4909-E	EVD 4911-E	EVD 4912-E	EVD 4913
Output power ¹⁾	P _{el} [kW]	139	210	294	420	504
Mains voltage	V _{mains}	3 · 340 ... 460 V ± 0%, 50...60Hz				
Armature voltage	V _A	420 V if V _{mains} = 400V (1.05 · V _{mains})				
Rated armature current (continuous operation)	I _{Arated} [A]	330	500	700	1000	1200
Maximum current (short-time operation)	I _{Amax} [A]	400	600	840	1200	1350
Field voltage ²⁾	V _F	V _{Fmax} = 0,875 V _{L1-L3}				
Max. field current, controlled	I _F [A]	15	30			
Power loss ³⁾	P _{loss} [W]	840	1220	2100	2850	3400
Ambient temperature in operation	T _{amb} [°C]	0...+35 ⁴⁾				
Weight approx.	[kg]	28	28	60	60	60

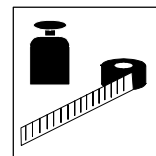

● Controllers 4808 to 4813 (2Q controllers)

	Type	4808	4809	4811	4812	4813
	Order No.	EVD 4808-E	EVD 4809-E	EVD 4811-E	EVD 4812-E	EVD 4813
Output power ¹⁾	P _{el} [kW]	152	230	322	460	552
Mains voltage	V _{mains}	3 · 340...460 V ± 0%, 50...60Hz				
Armature voltage	V _A	460 V if V _{mains} = 400 V (1.15 V _{mains})				
Rated armature current (continuous operation)	I _{Arated} [A]	330	500	700	1000	1200
Maximum current (short-time operation)	I _{Amax} [A]	400	600	840	1200	1350
Field voltage ²⁾	V _F	V _{Fmax} = 0.875 V _{L1-L3}				
Max. field current, controlled	I _F [A]	15	30			
Power loss ³⁾	P _{loss} [W]	830	1220	2100	2850	3400
Ambient temperature in operation	T _{amb} [°C]	0...+35 ⁴⁾				
Weight approx.	[kg]	28	28	60	60	60

1) referred to a mains voltage of 3 · 400V~

2) The field is controlled as a current source, i.e. the field voltage depends on the field resistance.

3) at rated armature current

4) T_{amb} ≤ 35°C: no power derating, 35°C < T_{amb} ≤ 45°C: power derating 1%/K

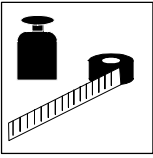

Technical Data

3.3.2 Mains voltage 500V (Variant V014)

- Controllers 4903 to 4907 (4Q controllers)

	Type	4903	4904	4905	4906	4907
	Order No.	EVD 4903-E-V014	EVD 4904-E-V014	EVD 4905-E-V014	EVD 4906-E-V014	EVD 4907-E-V014
Output power ¹⁾	P _{el} [kW]	13.1	28.8	57.7	105	131
Mains voltage	V _{mains}	3 · 410...550 V 0%, 50...60 Hz				
Armature voltage	V _A	525 V if V _{mains} = 500V (1.05 V _{mains})				
Rated armature current (continuous operation)	I _{Arated} [A]	25	55	110	200	250
Maximum current (short-time operation)	I _{Amax} [A]	45	90	150	240	300
Field voltage ²⁾	V _F	V _{Fmax} = 0.875 V _{L1-L3}				
Max. field current, controlled	I _F [A]	3.5	10			
Power loss ³⁾	P _{loss}	108	185	288	577	650
Ambient temperature in operation	T _{amb} [°C]	0...+45				0...+35 ⁴⁾
Weight approx.	[kg]	13.1	13,8	18	22	23

- Controllers 4908 to 4913 (4Q controllers)

	Type	4908	4909	4911	4912	4913
	Order No.	EVD 4908-E-V014	EVD 4909-E-V014	EVD 4911-E-V014	EVD 4912-E-V014	EVD 4913-E-V014
Output power ¹⁾	P _{el} [kW]	173	262	367	525	630
Mains voltage	V _{mains}	3 · 410...550 V ± 0%, 50...60Hz				
Armature voltage	V _A	525 V if V _{mains} = 500 V (1.05 V _{mains})				
Rated armature current (continuous operation)	I _{Arated} [A]	330	500	700	1000	1200
Maximum current (short-time operation)	I _{Amax} [A]	400	600	840	1200	1350
Field voltage ²⁾	V _F	V _{Fmax} = 0.875 V _{L1-L3}				
Max. field current, controlled	I _F [A]	15	30			
Power loss ³⁾	P _{loss} [W]	840	1220	2100	2850	3400
Ambient temperature in operation	T _{amb} [°C]	0...+35 ⁴⁾				
Weight approx.	[kg]	28	28	60	60	60

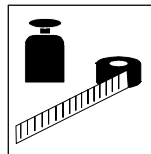

● Controllers 4808 to 4813 (4Q controllers)

	Type	4808	4809	4811	4812	4813
	Order No.	EVD 4808-E-V014	EVD 4809-E-V014	EVD 4811-E-V014	EVD 4812-E-V014	EVD 4813-E-V014
Output power ¹⁾	P_{el} [kW]	189	287	402	575	690
Mains voltage	V_{mains}	3 · 410...550 V ± 0%, 50...60Hz				
Armature voltage	V_A	575 V if $V_{mains} = 500$ V (1.15 V_{mains})				
Rated armature current (continuous operation)	I_{Arated} [A]	330	500	700	1000	1200
Maximum current (short-time operation)	I_{Amax} [A]	400	600	840	1200	1350
Field voltage ²⁾	V_F	$V_{Fmax} = 0.875 V_{L1-L3}$				
Max. field current, controlled	I_F [A]	15	30			
Power loss ³⁾	P_{loss} [W]	830	1220	2100	2850	3400
Ambient temperature in operation	T_{amb} [°C]	0...+35 ⁴⁾				
Weight approx.	[kg]	28	28	60	60	60

1) referred to a mains voltage of 3 · 500V~

2) The field is controlled as a current source, i.e. the field voltage depends on the field resistance.

3) at rated armature current

4) $T_{amb} \leq 35^\circ\text{C}$: no power derating, $35^\circ\text{C} < T_{amb} \leq 45^\circ\text{C}$: power derating 1%/K

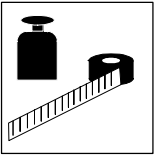

Technical Data

3.4 Dimensions

3.4.1 Controller 4902 to 4X09

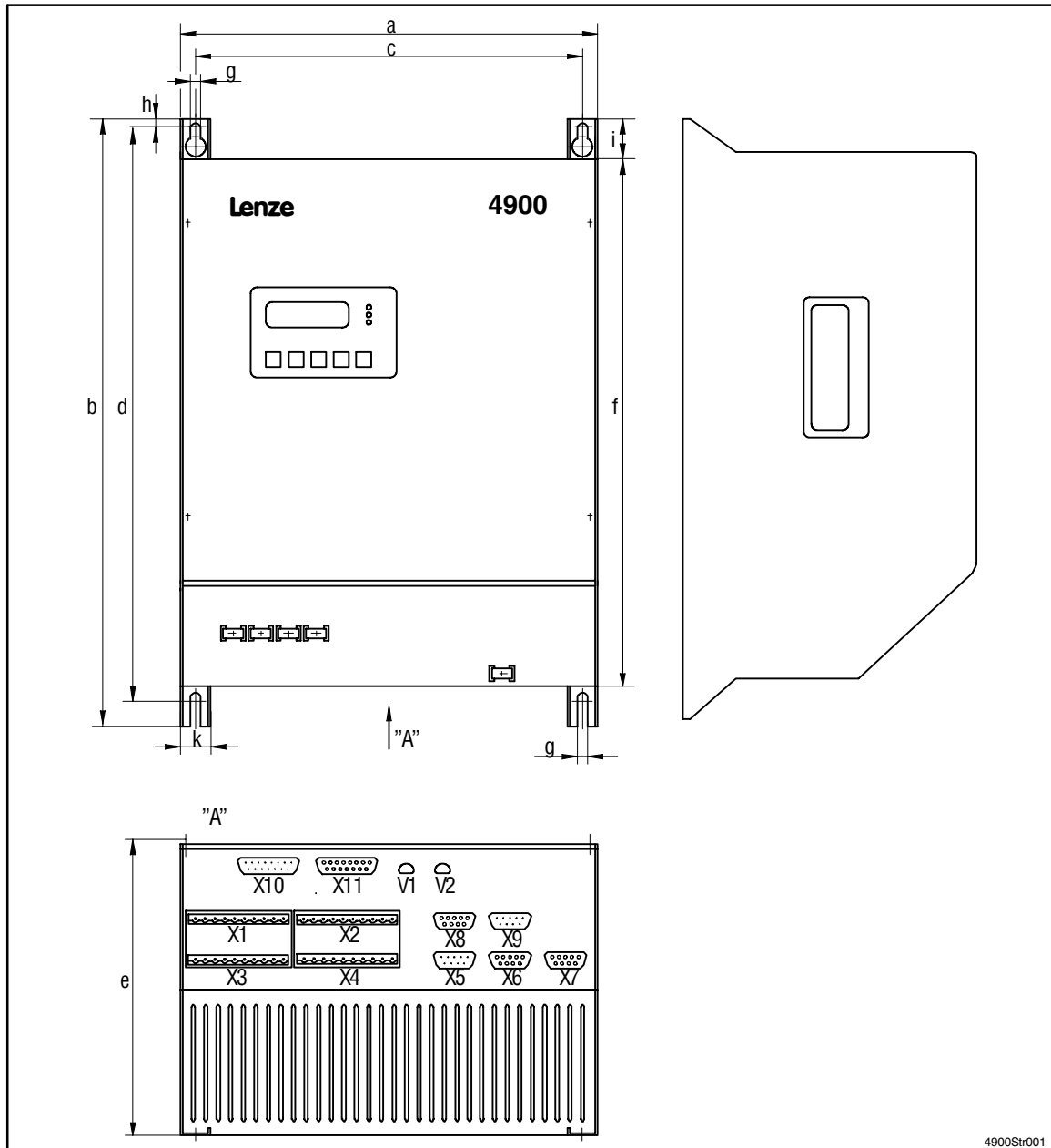
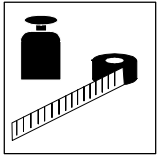

FIG 4-1 Dimensions of the controllers 4902 to 4907, 4X08 and 4X09

all dimensions in mm

Type	a	b	c	d	e	f	g	h	i	k	l
4902 / 4903 / 4904	269	415	242	395	222	360	6.5	8	30	26	175
4905 / 4906 / 4907	269	525	242	505	222	466	6.5	8	30	26	175
4808 / 4809 / 4908 / 4909	322	550	288	525	335	497	6.5	8	30	34	295



3.4.2 Controllers 4811 to 4813, 4911 to 4913

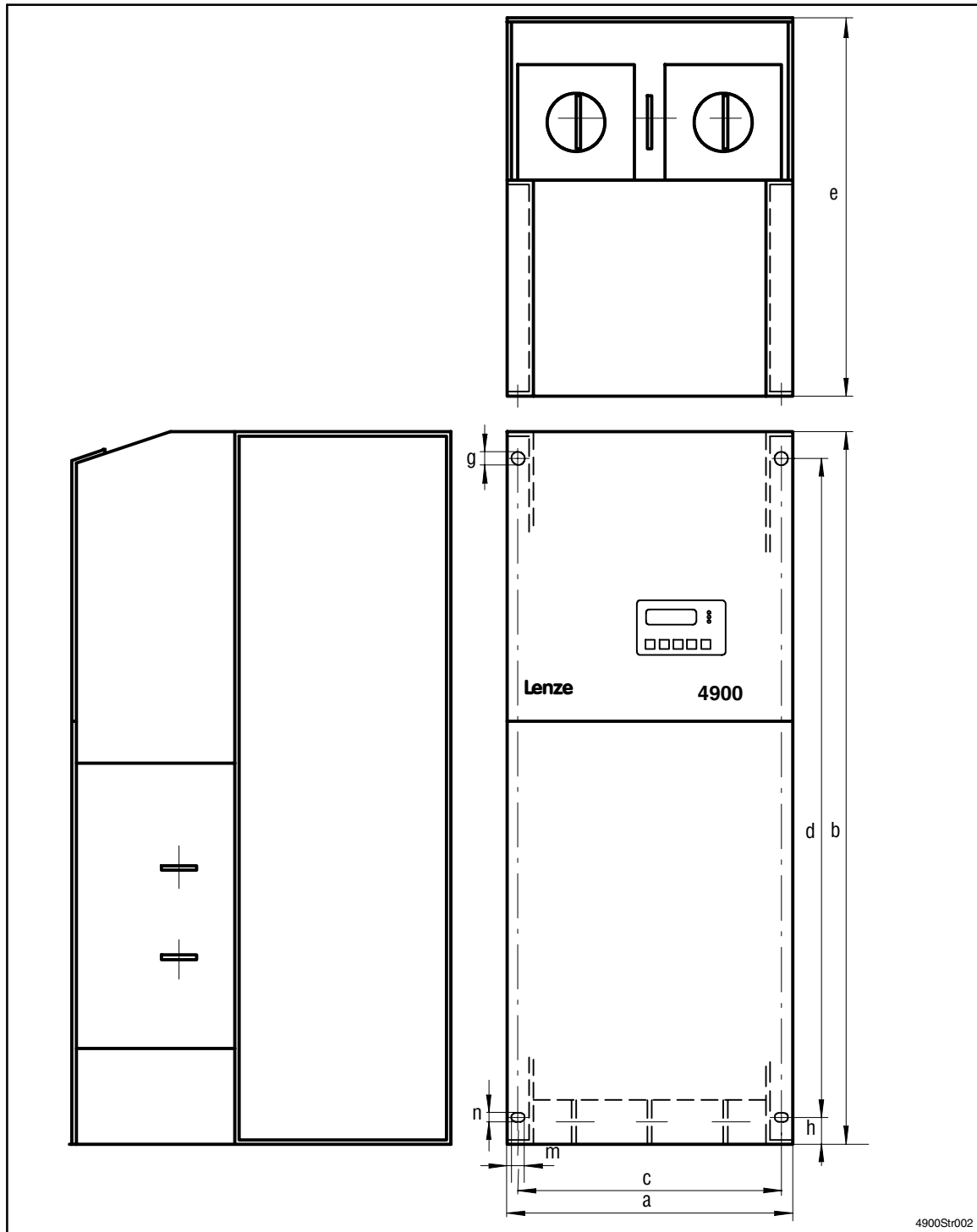
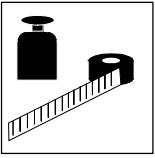

FIG 4-2 Dimensions of the controllers 4X11 to 4X13

all dimensions in mm

Type	a	b	c	d	e	g	h	m	n
4811 - 4813 / 4911 - 4913	322	800	292	740	390	9	30	15	9



Technical Data

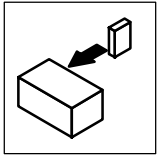

4 Installation

4.1 Mechanical installation

4.1.1 Important notes

- Ensure free installation space above and below the controller:
 - 100 mm for 4902...4907
 - 150 mm for 4X08...4X13
- Ensure unimpeded ventilation of cooling air and outlet of exhaust air.
- If the cooling air contains pollutants (dust, fluff, grease, aggressive gases), which may impair the function of the controller:
 - Take suitable preventive measures , e.g. separate air duct, installation of filters, regular cleaning, etc.
- Do not exceed the ambient temperature permissible during operation:
 - 4902...4906: to 45 °C: without power derating
 - 4907, 4X08...4X13: to 35 °C: without power derating
35 °C to max. 45 °C: power derating 1% / K

Possible mounting positions

- Only vertical controller installation:
 - 4902 ... 4907, 4X08 and 4X09 with mains connections on top
 - 4X11 ... 4X13 with mains connections at bottom

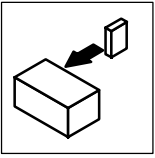

Installation

4.2 Electrical installation

For information on the installation according to EMC, see chapter 4.4

4.2.1 Protection of persons

- Protection of persons and animals according to DIN VDE 0100 with current-operated protective devices:
The inverters are equipped with a mains rectifier. After a short-circuit to frame, a DC fault current may prevent the tripping of the current-operated protective device. Additional measures, such as protective multiple earthing or universal current sensitive current-operated e.l.c.b., should therefore be taken.
- When dimensioning the tripping current of the current-operated e.l.c.b. it must be observed that false tripping may occur under the following conditions:
 - In the event of capacitive leakage currents between the cable screens (especially with long screened motor cables).
 - If several controllers are connected to the mains at the same time.
 - If you use RFI filters.
- Comment on the application of universal-current sensitive current-operated e.l.c.b.:
The preliminary standard prEN50178 (previously VDE0160) on the application of universal-current sensitive current-operated e.l.c.b. has passed the German Committee K226.
The final decision about this standard will be made by CENELEC/CS (European Committee for Electrotechnical Standardization) in Brussels. For further information on the application of universal-current sensitive current-operated e.l.c.b., can be obtained from the supplier.
- Replace defective fuses with the prescribed type only when no voltage is applied. The fuses protect the controller from impermissible operating conditions. After tripping, the controller or the system should be checked for possible faults or errors before replacing the fuse.
- The controller can be safely disconnected from the mains via a contactor on the input side.

Electrical isolation

There is an electrical isolation (insulating distance) between power and control terminals:

- The reference potential GND of the control electronics is connected to PE via a bridge (bridge to X4; term. 90 term. FE)
- The control electronics has a basic isolation (single insulating distance).
- The protection against contact, if the insulating distance is defective, can only be ensured by additional measures.

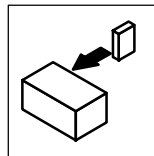

4.2.2 Protection of the controller



Stop!

The controllers contain electrostatically sensitive components: Prior to assembly and service operations, the personnel must be free of electrostatic charge, e.g. by touching the PE fixing screw or other grounded metal surfaces in the control cabinet.

- In the event of condensation, connect the controller to the mains voltage only after the visible humidity has evaporated.
- The controllers are designed for operation with a neutral earth mains voltage.
- For separate supply of the field controller:
 - Ensure correct phase connection of the terminals L1.1 and L3.1. The PEN conductor must never be connected!
- The power outputs of the controller for the armature circuit (A, B) and the field circuit (I, K) must only be disconnected when no voltage is applied.
- Use the prescribed semiconductor fuses to protect the thyristors in the power stage (see chapter 13.1).
- For speed control with incremental encoder:
 - Only use incremental encoders with pulse tracks shifted by 90°.
- For speed control with tacho:
 - Only use DC tacho generators.

4.2.3 Screening of the control cables

Wire the screening and the GND and PE connections very carefully to avoid interference. Interference in the control cables can interrupt operation, because it disturbs the controller program (fault message 'CCr').

- Screening of control cables.
 - Connect the screen of the control cables to the screen connections of the controller or via the isolated earthing bus in the control cabinet (e.g. PE terminals).
- Prevent breaks in the screening:
 - In the event of interruption, screening must be connected to protective buses (terminal strips, relays, fuses).
 - Low-resistance connection between buses (at least 10 mm²) and PE of the supply.
- Control cables must not be installed parallel to motor cables carrying interference.
 - If it is not possible to ensure an installation distance between control and motor cables, the motor cables should be screened.

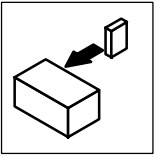

Installation

4.2.4 Earthing of the control electronics

Single drives

- With factory setting, the reference potential GND of the control electronics is joined to PE. Additional earthing measures are not required.

Group drives

- Ensure that earthing the control electronics does not cause any damage to external controllers.
- Ensure to avoid ground loops when the ground is connected (GND):
 - Remove the bridge to X4 from terminal 90 to terminal FE.
 - All ground cables must be connected to externally isolated buses which are as close to the controllers as possible.
 - Make a low-resistance connection between the buses (at least 10 mm²) and PE of the supply.

4.2.5 Mains types and conditions

Please observe the restrictions for each mains type!

Mains	Operation of the controller	Notes
With grounded neutral	No restrictions	Observe controller ratings
With grounded phase	Operation is impossible.	
With isolated neutral (IT mains)	Operation with the recommended RFI filter is only possible if an isolating transformer is preconnected. The neutral of the secondary circuit must be earthed secondarily.	Contact Lenze. The RFI filter will be destroyed when directly connected to the IT mains and fault "earth fault".

Interaction with compensation equipment

For reactive-power compensation of mains with an inverter controller load, the compensation unit should be equipped with a choke, since the controller generates harmonic currents. These harmonic currents could excite oscillating circuits which consist of mains impedance and capacitor reactance. Capacitors, transformers, switching units, etc. could be destroyed by these reactance effects.

In this case, please contact the supplier of your compensation equipment.

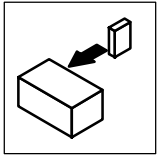

4.3 Connection

Connection between controller and motor

Lenze controller			Motor (to DIN 42017/VDE 0530 part 8)		
Function		Terminal	Terminal	Others	Motor type
Armature voltage	+	A	1B1	A1	DC motor uncompensated with commutating winding
	-	B	2B2	B2, A2	
Excitation voltage	+	I	F1	F5, (for higher connection voltages)	
	-	K	F2	F2	
Armature voltage	+	A	1C1	A1	DC motor compensated with commutating winding
	-	B	2C2	C2	
Excitation voltage	+	I	F1	F5, (for higher connection voltages)	
	-	K	F2	F2	
Armature voltage	+	A	A1		Permanent-magnet motor
	-	B	A2		
DC tachometer	+	3	2A1		
	-	4	2A2		
Temp. switch			S1, S2		
Thermal contact			T1, T2		

Screw-tightening torques

Type	4902	4903 - 4904	4905 - 4907	4X08 - 4X09	4X11 - 4X13
L1, L2, L3, A, B	0.5 ... 0.6 Nm	2.0 ... 2.4 Nm	37 Nm ¹⁾		64 Nm ¹⁾
A, B			37 Nm ¹⁾	15 ... 20 Nm	
L1.1, L3.1, I, K	0.5 ... 0.6 Nm			1.2 ... 1.5 Nm	
L1.2, L2.2, L3.2	0.5 ... 0.6 Nm				
L1.3, L2.3, L3.3, 86 - 89	-			0.5 ... 0.6 Nm	
Terminal strip X1 - X4	0.5 ... 0.6 Nm				

- 1) Rated tightening torque for the connection of terminal ends to busbars (VDE 0220 part 1/11.71)
When continued with busbar see DIN 43673 part 1/02.82

The following circuit diagrams show the electrical wiring of the power connections.

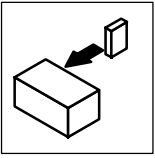

Installation

4.3.1 Power connection of standard controller

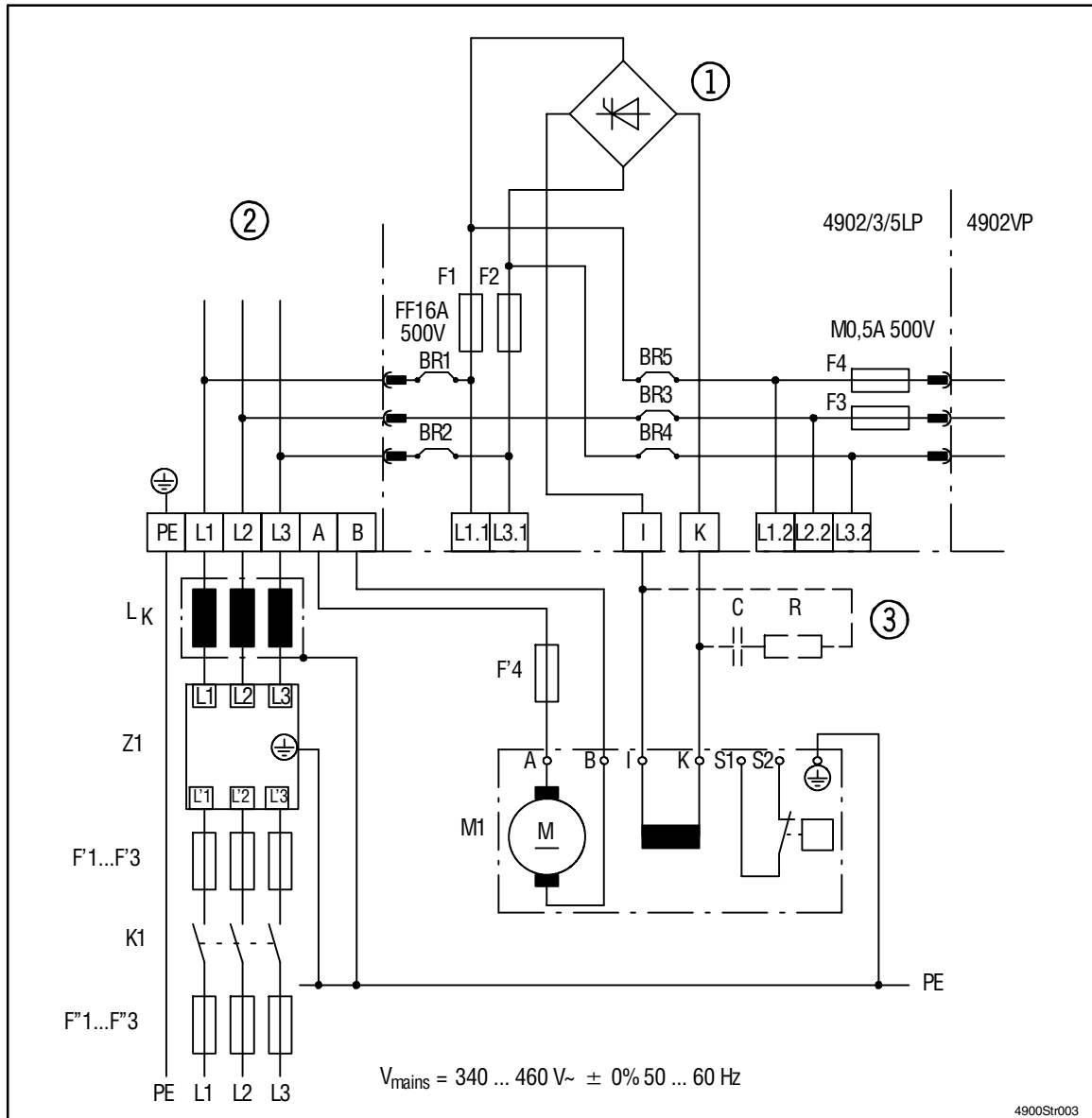

FIG 4-3 Power connection of controllers 4902 to 4907

K1	Mains contactor
F1...F4	Semiconductor fuses for controller protection
F'1...F'3	Line protection fuses
L _k	Commutating choke (mains choke)
Z1	RFI filter
BR1 - BR5	0 wire bridge
①	Field controller
②	Power stage
③	Auxiliary starting circuit

With field voltages > 300V and field currents < 200mA an auxiliary starting circuit should be used.
Recommended dimensioning: R = 330 / 20 W; C = 0.22 F/400V AC.

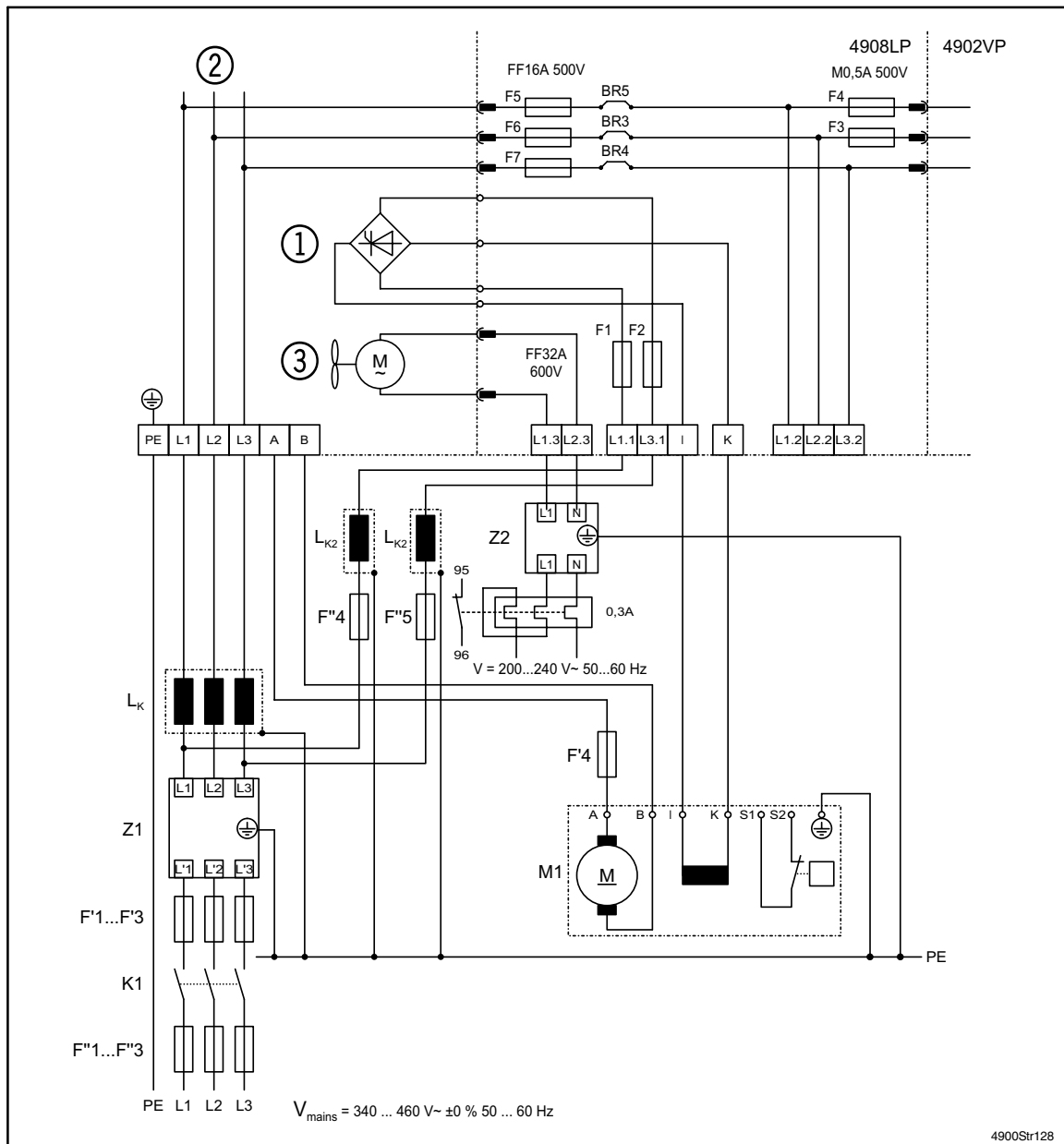
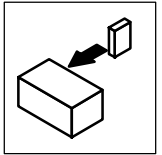
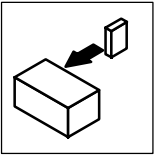

FIG 4-4 Power connection of controllers 4X08 to 4X09

- K1 Mains contactor
- F'1...F'4 Semiconductor fuses for the protection of controllers
- F''1...F''5 Line protection fuses
- L_k Commutating choke (mains choke)
- Z1 RFI filter
- Z2 RFI filter for separate fan supply
- BR3 - BR5 0 wire bridge
- ① Field controller
- ② Power stage
- ③ Fan



Installation

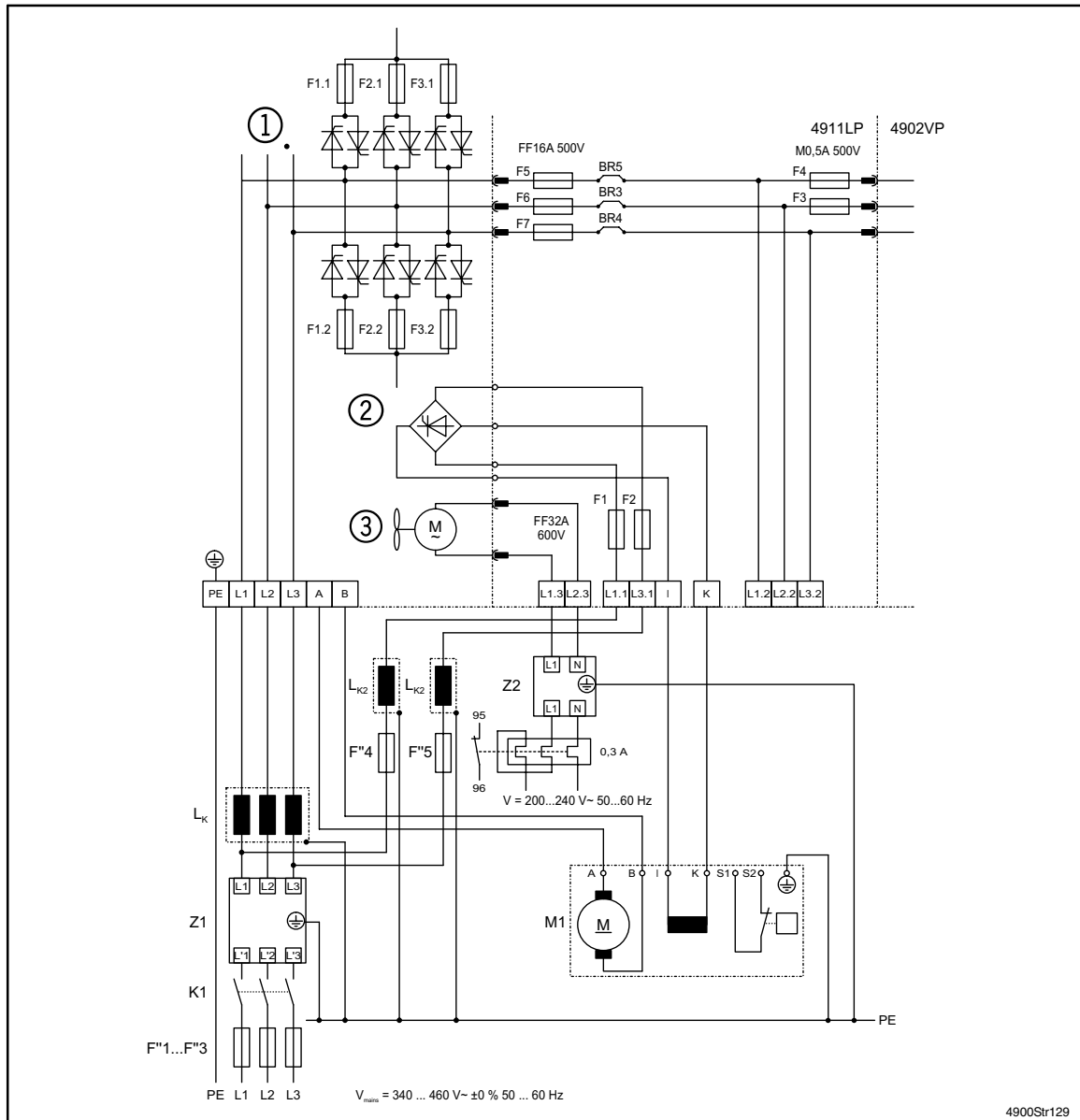
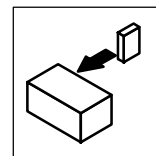

FIG 4-5 Power connection of controllers 4X11 to 4X13

- | | |
|----------------|---|
| K1 | Mains contactor |
| F1.1 ... F3.2 | Semiconductor fuses for controller protection |
| F"1...F"5 | Line protection fuses |
| L _k | Commutating choke (mains choke) |
| Z1 | RFI filter |
| Z2 | RFI filter for separate fan supply |
| BR3 - BR5 | 0 wire bridge |
| ① | Power stage |
| ② | Field controller |
| ③ | Fan |

It is not necessary to protect mains and armature cables by semiconductor fuses, because the thyristors are already protected by internal cell fuses.



4.3.2 Separate supply of the field-current bridge at a high motor field voltage



Stop!

Ensure correct phase connection of the separate field supply. Incorrect connection leads to blown fuses.

The phase shift of the voltages from the power stage to the control electronics must be smaller than 2 °(electrically).

To reduce the mains feedback, separate mains chokes are required for the field supply (chapter 13.2.2).

The fuses F'4 and F'5 are cable protection fuses. They must be matched to the cross section of the cables used and dimensioned for at least $I_{F_{rated}}$.

In weak mains supplier, field-current fluctuations may occur and thus the torque can be reduced. For rated field voltages $V_{F_{rated}} > 210V$, we recommend a separate supply for the field bridge.

The armature current control circuit and the field current control circuit are electrically decoupled by an external supply for the field controller with voltage pick-off before the mains choke.

Remove the wire bridges BR1 and BR2 of the controllers 4902 to 4907 (4902LP, 4903LP or 4905LP) when no voltage is applied. The bridges can be easily accessed:

1. Open the controller cover (4 mounting screws)
2. Unbolt the 2 mounting screws for the cover of the control electronics
3. Open the cover.

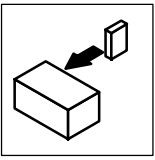

Installation

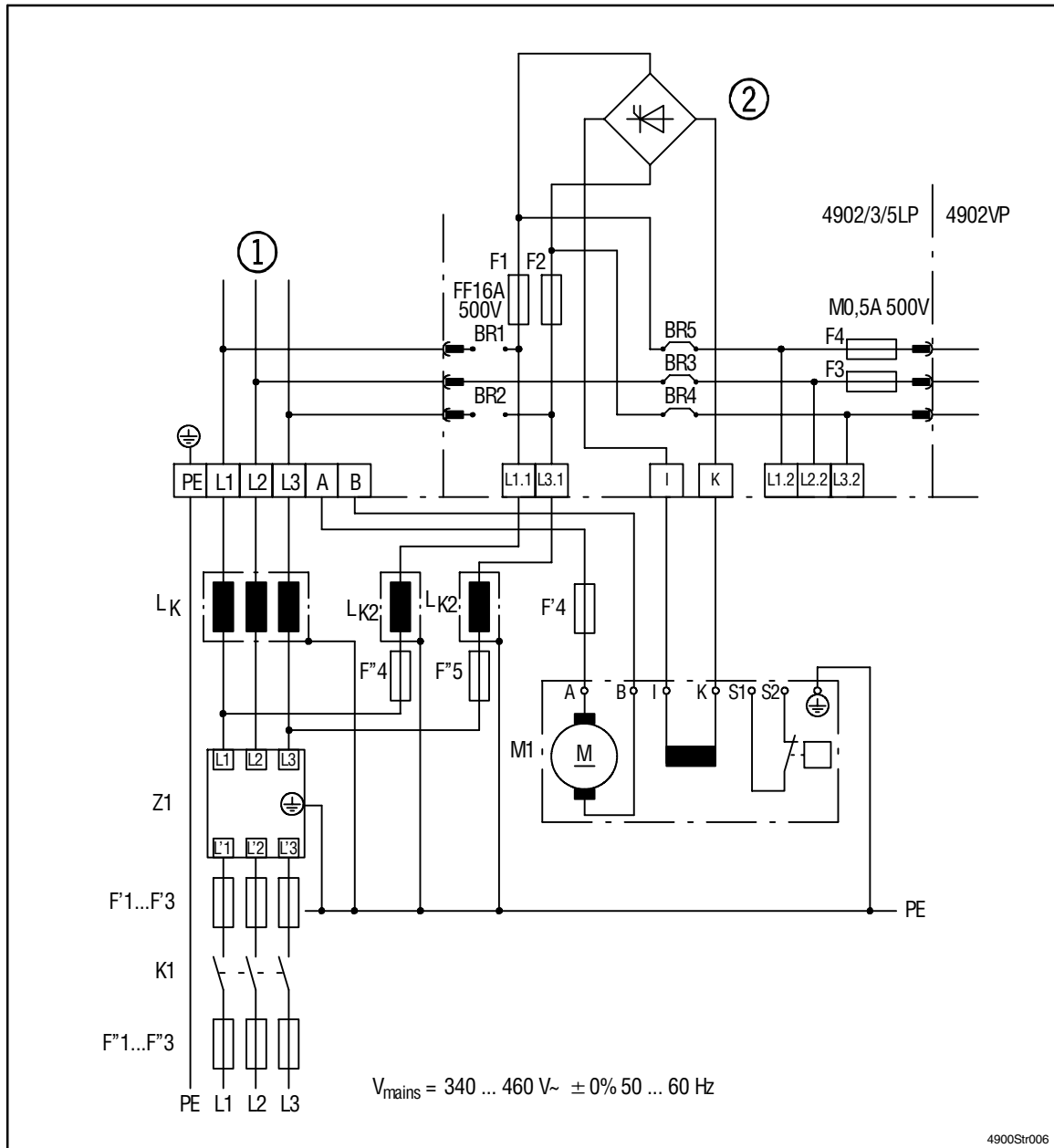
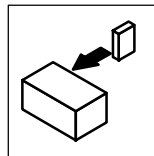

FIG 4-6 Power connection for controllers 4902 to 4907

- | | |
|----------------|---|
| K1 | Mains contactor |
| F'1...F'4 | Semiconductor fuses for controller protection |
| F''1...F''5 | Line protection fuses |
| L _K | Commutating choke (mains choke) |
| Z1 | RFI filter |
| BR3 - BR5 | 0 wire bridge |
| ① | Power stage |
| ② | Field controller |



4.3.3 Separate supply for the control electronics



Stop!

Ensure correct phase connection of the separate mains supply.
Incorrect connection leads to blown fuses.

- The phase shift of the voltages from the power stage to the control electronics must be smaller than 2° (electrically).
- The controller must be inhibited via the function "Controller enable" (Ctrl. enable) before the contactor can be opened or closed. If the switching sequence is not observed, the fuses will blow or fault messages ACI or FCI will be indicated.
- The electronics remains supplied after K1 has been opened. The mains is completely separated via the main switch.

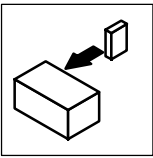

Installation

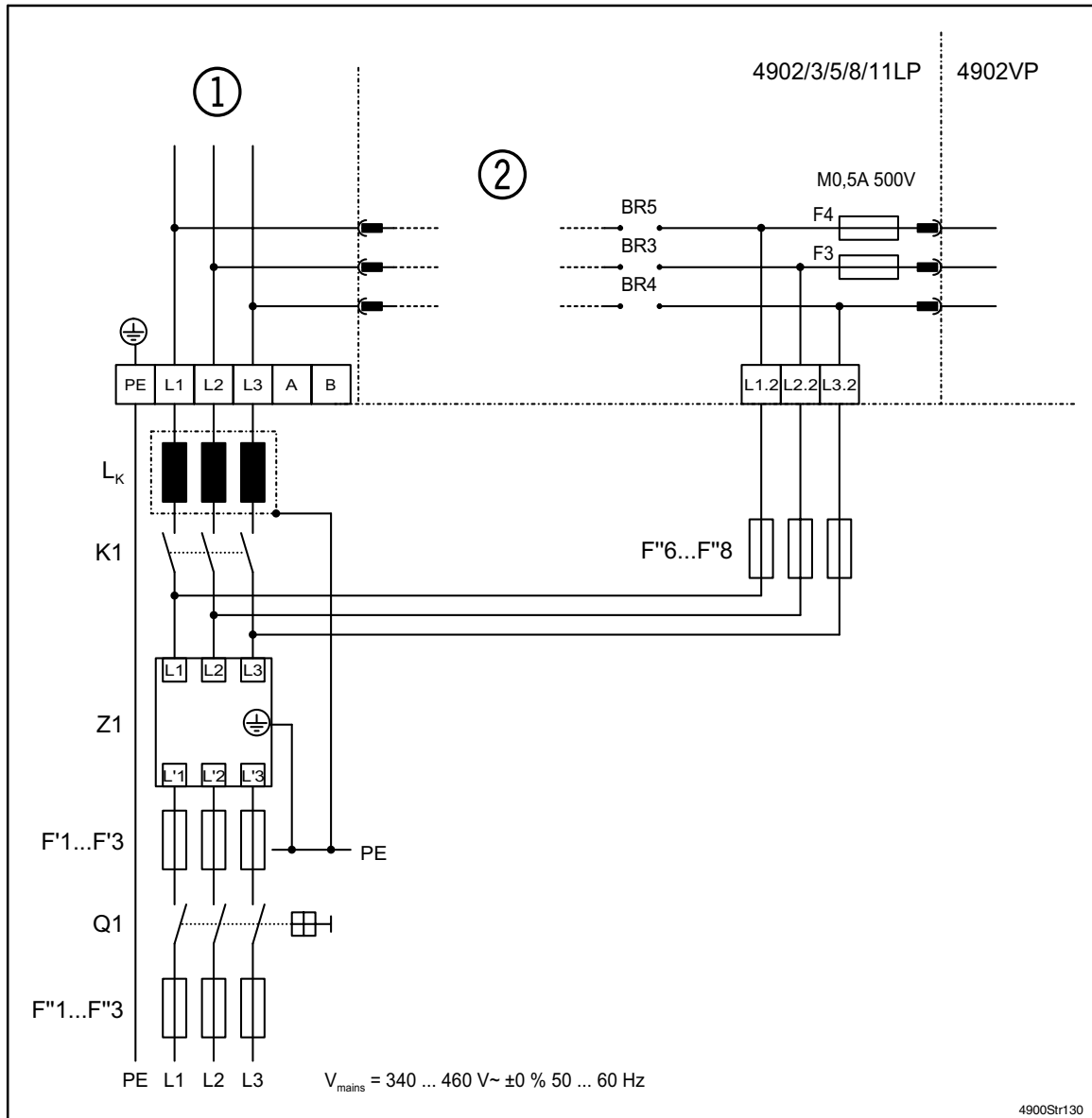
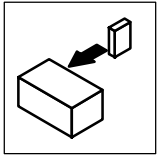

FIG 4-7 Power connection for controllers 4902 to 4907 and 4X08 to 4X13

- | | |
|----------------|---|
| K1 | Mains contactor |
| F'1...F'3 | Semiconductor fuses for controller protection |
| F''1...F''3 | Line protection fuses |
| F''6...F''8 | Cable protection fuses 4A |
| L _k | Commutating choke |
| Z1 | RFI filter |
| Q1 | Main switch |
| ① | Power stage |
| ② | Field controller |



4.3.4 Control connections

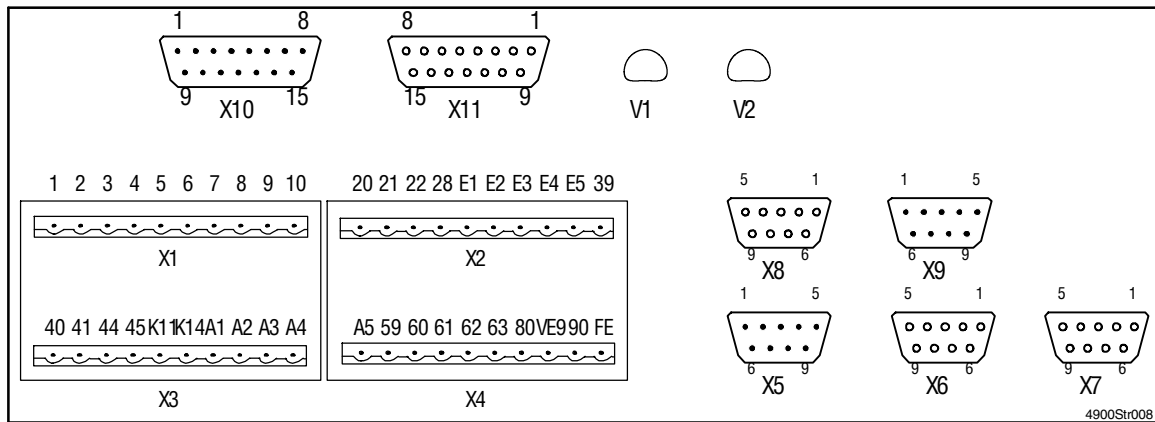

FIG 4-8 Control connections for the controller

X1 - X4	Control terminals
X5	Digital frequency/incremental encoder input (Dig_In_1)
X6	LECOM1 interface (RS 232 / 485)
X7	Resolver connection
X8	Digital frequency output
X9	Digital frequency/incremental encoder input (Dig_In_2)
X10, X11	Fieldbus connections (as option e.g. 2110 for InterBus)
V1, V2	Displays for fieldbus options (option)

Switch on the control module

Some function of inputs and outputs can be changed via the switches on the control module 4902MP. For settings ensure

- that no voltage is applied
- the cover is removed (4 mounting screws)

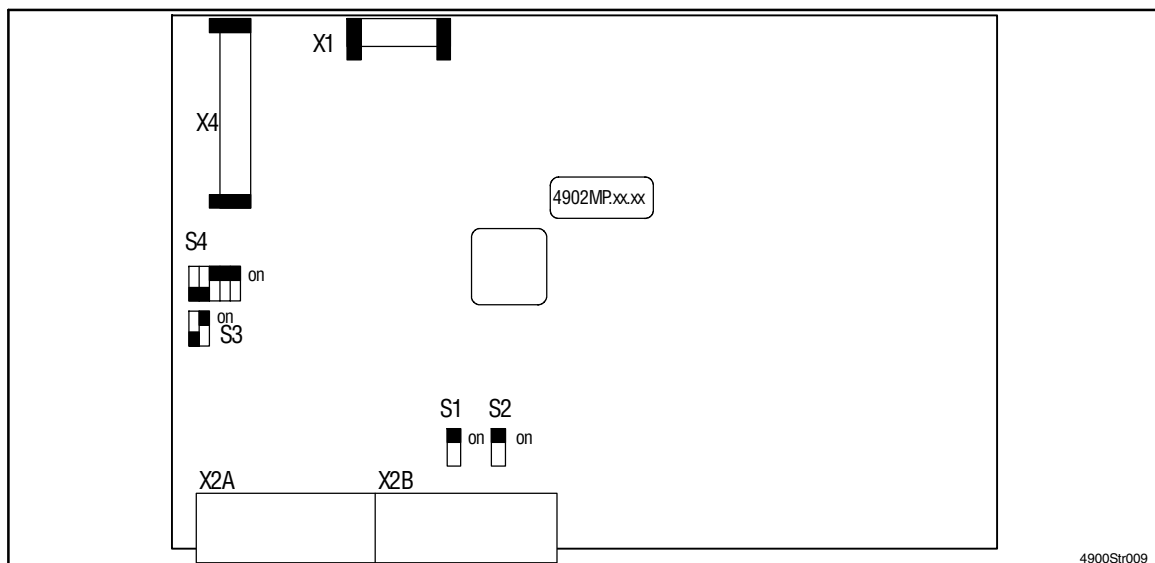
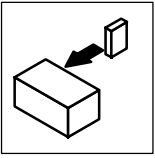

FIG 4-9 Positions of switches S1 to S4 on the control module



Installation

4.3.4.1 Connection of analog signals

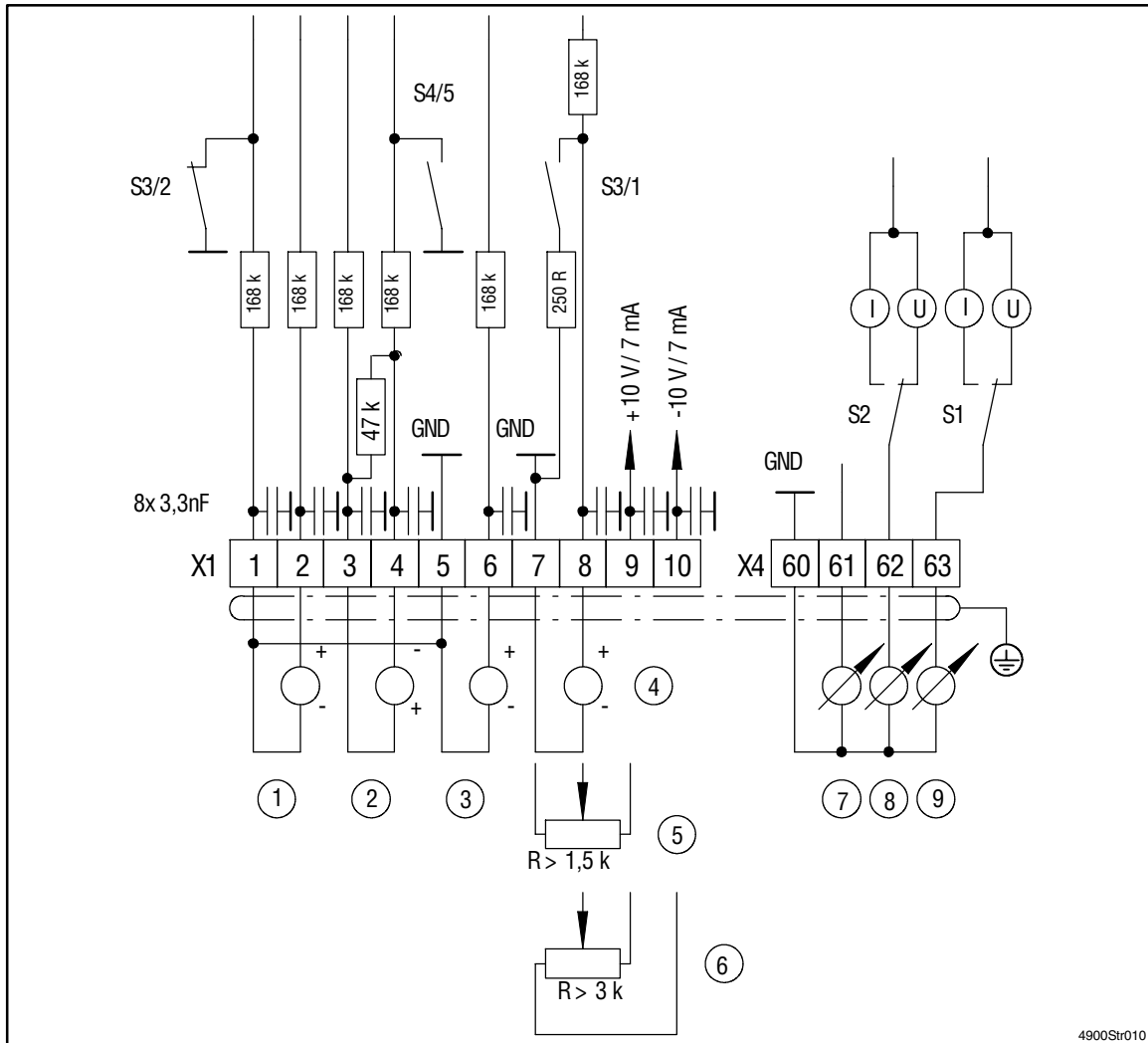
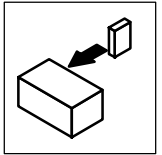



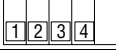
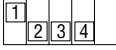
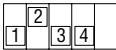
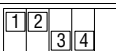
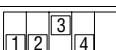
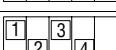
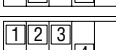
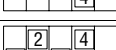

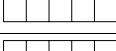

FIG 4-10 Analog inputs and outputs

①	External torque limitation	Setpoint 2	Analog input
②	Actual value signal with tacho feedback		
③	Additional setpoint	Setpoint 3	
④	Main setpoint as digital master voltage/current	Setpoint 1	
⑤	Main setpoint as unipolar setpoint		
⑥	Main setpoint as bipolar setpoint		
⑦	Armature current I_{act}		Monitor output
⑧	Current setpoint C063		
⑨	Actual speed value C051		

The analog signals are contacted via the terminal blocks X1 and X4. FIG 4-10 shows the function assignment according to factory setting.





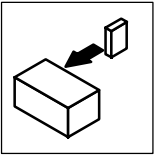

Analog inputs

Terminal	Switch position	Use	Level	Resolution
1, 2	S3  ON OFF	Setpoint 2 with ground reference (factory setting)	-10V...+10V	12 bit + sign
	S3  ON OFF	Setpoint 2 differential input	-10V...+10V	12 bit + sign
3, 4	S4  ON OFF	Actual value	-10V...+10V	12 bit + sign
	S4  ON OFF	Actual value	-30V...+30V	12 bit + sign
	S4  ON OFF	Actual value	-60V...+60V	12 bit + sign
	S4  ON OFF	Actual value (factory setting)	-73V...+73V	12 bit + sign
	S4  ON OFF	Actual value	-90V...+90V	12 bit + sign
	S4  ON OFF	Actual value	-99V...+99V	12 bit + sign
	S4  ON OFF	Actual value	-120V...+120V	12 bit + sign
	S4  ON OFF	Actual value	-180V...+180V	12 bit + sign
	S4  ON OFF	Actual value with ground reference		12 bit + sign
	S4  ON OFF	Actual value differential input ¹⁾		12 bit + sign
6		Setpoint 3 with ground reference	-10V...+10V	12 bit + sign
7		Internal ground, GND		
8	S3  ON OFF	Setpoint 1, Master voltage (factory setting)	-10V...+10V	12 bit + sign
	S3  ON OFF	Setpoint 1, Master current	-20mA...+20mA -20 mA...-4 mA +4 mA...+20 mA	
9		Voltage supply for	+10V/7mA	
10		Setpoint selection via potentiometer	-10V/7mA	



Installation

Analog outputs (monitor outputs)

Terminal	Switch position	Use	Level	Resolution
60		Internal ground, GND		
61		Actual current value	-5 V...+5 V correspond to the rated current of the controller	
62	S2 	Monitor 1 Output voltage(factory setting)	-10V...10V	11 bit
	S2 	Monitor 1 Output current	-20mA...+20mA	11 bit
63	S1 	Monitor 2 Output voltage(factory setting)	-10V...+10V	11 bit
	S1 	Monitor 2 Output current	-20mA...+20mA	11 bit

- 1) For changing the factory setting of switch S4, jumper 5 to ON (actual value with ground reference), observe the following:
- Bridge terminals 4 and 5 externally.
 - Set DIP switch S4, jumper 1-4 (preselected actual value) to double tacho voltage.

The max. possible tacho voltage is 90 V!

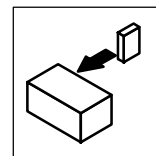

4.3.4.2 Connection of digital signals

- All digital inputs and outputs are PLC compatible and separated from the rest of the control module when operated with an external voltage supply (24 V).
- The diagrams show the function assignments according to the factory setting.
- For switching the signal cables, only relays with contacts for low-level switching should be used.
We recommend using relays with gold contacts.
- Voltage supply
 - external 24 V to terminals X2/39 and X4/59 or
 - internal 15 V to terminal X2/20



Stop!

- Maximum permissible load of the internal 15 V supply : 100 mA.
- For operation with internal voltage: Bridge terminals X2/39 and X3/40 externally.
- Digital inputs unused should be connected!

Inputs:

Input voltage	0...+30 V	
	LOW level:	0...+5 V
	HIGH level:	+13...+30 V
Input current:	24 V:	8 mA per input
	15 V:	5 mA per input

Outputs:

Output current:	Max. 50 mA per output (external resistance min. 480 Ω at 24V, e. g. relay, order designation EK0005)
-----------------	---

The input and output signals are in average read, processed and updated every 4 msec on average.

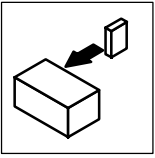

Installation

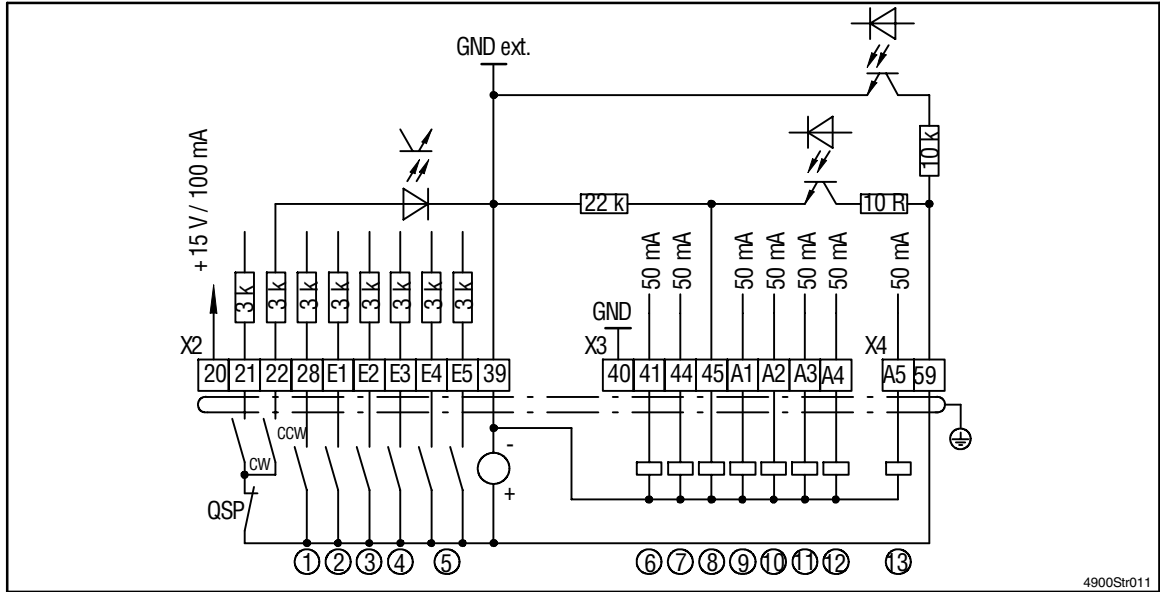

FIG 4-11 Digital inputs and outputs with external voltage supply (24 V)

4900Str011

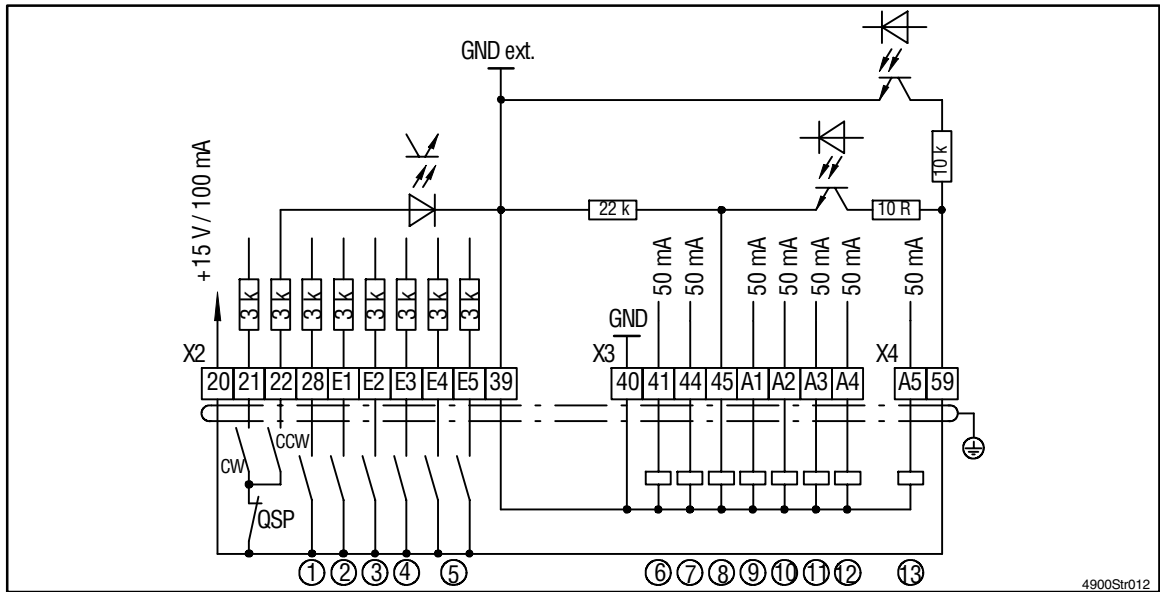
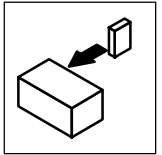

FIG 4-12 Digital inputs and outputs with internal voltage supply (15 V)

4900Str012



Digital inputs

Name	Terminal	Use (factory setting)	Level for activation	Programming see chapter
	20	Voltage supply 15V, 100mA		
CW	21	Removal of quick stop, CW rotation	HIGH	
CCW	22	Remove quick stop, CCW rotation	HIGH	
1	28	Controller enable - Ctrl. enable	HIGH	
2	E1	Freely assignable input (TRIP set)	HIGH	
3	E2	Freely assignable input (TRIP reset)	HIGH	
4	E3	Freely assignable input (Inhibit additional setpoint)	HIGH	
5	E4, E5	Freely assignable input (Enable JOG values, three JOG values)	HIGH	

Digital outputs

Name	Terminal	Use (factory setting)	Message		Programming see chapter
			1)	2)	
	39	Ground of the digital inputs and outputs, external GND			
	40	Internal ground, GND			
6	41	TRIP	HIGH	LOW	
7	44	Ready for operation RDY	HIGH	HIGH	
8	45	Pulse inhibit IMP	HIGH	LOW	
9	A1	Freely assignable output ($n_{act} < n_x$)	HIGH	LOW	
10	A2	Freely assignable output (n-controller = M_{max})	LOW	HIGH	
11	A3	Freely assignable output (Setpoint reached, $RFG_{output} = RFG_{input}$)	HIGH	HIGH	
12	A4	Freely assignable output ($n_{act} = 0$)	HIGH	LOW	
13	A5	Freely assignable output ($n_{act} = n_{set}$)	HIGH	HIGH	
	59	Supply input of the digital outputs: 24 V external or 15 V internal			

1) Message in stationary controller operation

2) Message, if the function is active

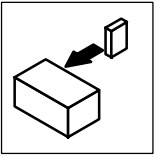

Installation

Relay output

<p style="text-align: center;">4900Str063</p>	Terminal	Use (factory setting)
	K11, K14	Floating relay output, contact load capacity: 50V / 0.5A (TRIP)

Additional digital inputs and outputs with 4X08...4X13

The controllers 4X08...4X13 are equipped with additional control terminals to monitor the fuses. The following current flow charts show the factory setting of the internal wiring and give suggestions on how to include an external fuse monitoring.

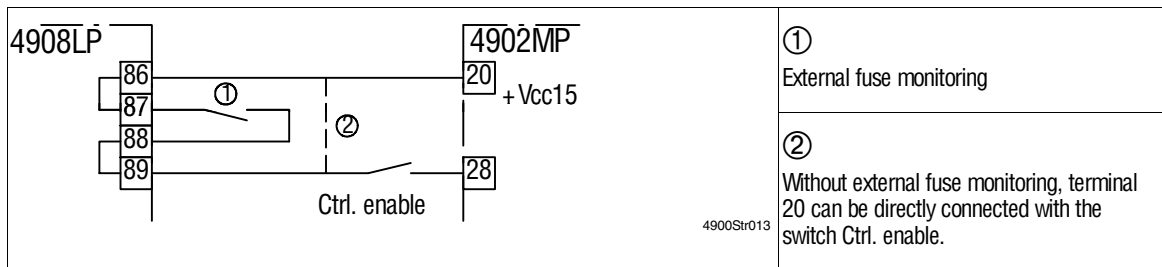

FIG 4-13 4808...4809 and 4908...4909

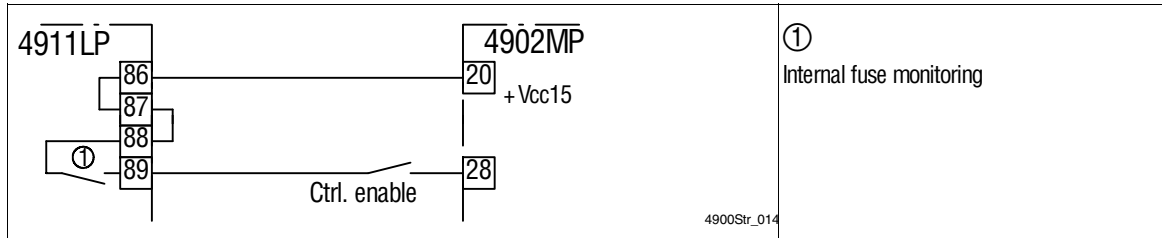

FIG 4-14 4811...4813 and 4911...4913

For monitoring, the terminals 86 and 89 should be connected in series with the controller enable contact Ctrl. enable.

- For internal voltage supply (15 V), bridge the following terminals:
 - X2/20 to 86
 - X2/28 to 89
- For external voltage supply (24 V):
 - Apply supply voltage to terminal 86.
 - Bridge terminals 28 and 89.



Danger! (especially for hoist applications)

Please observe when connecting the fuse monitoring:
No torque is generated when the controller is inhibited.

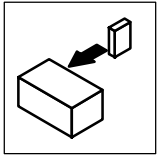

4.3.5 Feedback systems

Several feedback systems can be connected to the controller and configured:

- Armature voltage control
- DC tacho feedback
- Resolver feedback
- Encoder feedback
 - Incremental encoder TTL
 - Incremental encoder HTL

DC tacho feedback

Tacho signals are connected via term. 3/4 of terminal block X1. The controller processes rated tacho voltages of 10...180V (chapter 4.3.5.1).

Resolver feedback (X7)

- 2-pole resolver ($V = 10\text{ V}$, $f = 5\text{ kHz}$)
- Connection to a 9-pole Sub D socket X7
 - We recommend to use the pre-cut Lenze system cable (see chapter 13.3).
- Resolver cable and resolver are monitored for wire breakage (fault message "Sd2")

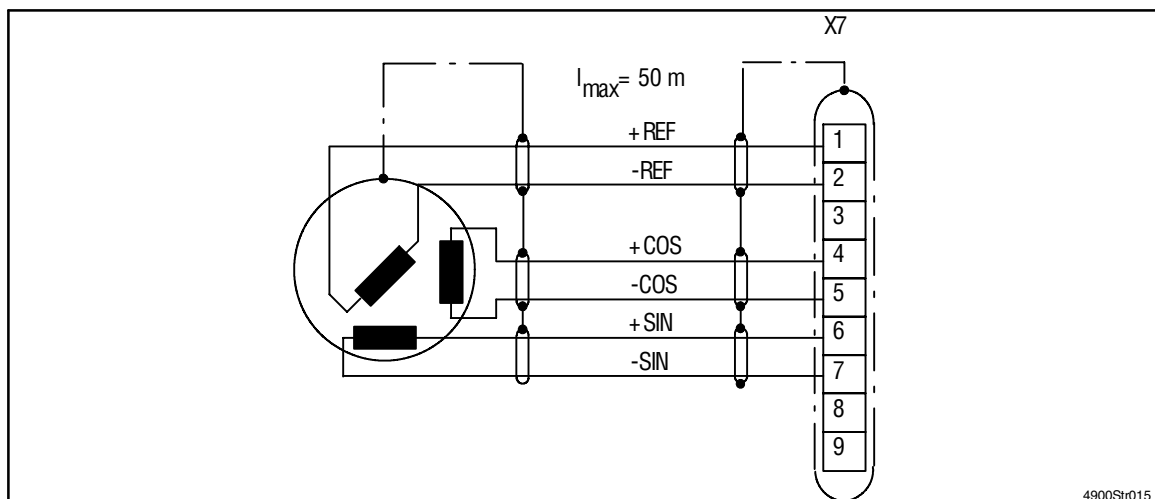
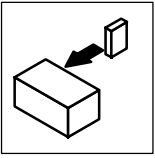

FIG 4-15 Resolver connection (9-pole Sub D socket)

Pin assignment of socket X7:

Pin	1	2	3	4	5	6	7	8	9
Signal	+ REF	-REF	GND	+COS	-COS	+SIN	-SIN	---	---
Cross section	0.5		0.14						



Installation

The resolver signal or encoder signal can be output for following drives at the digital frequency output X8.

- Connection as shown in the connection diagrams:
 - Use cables twisted and screened in pairs.
 - Connect both screen ends.
 - Use cable cross-sections indicated.
- The feedback system can be activated under C005.
- If resolvers are used which are not specified by Lenze are used, contact your Lenze representative.

Incremental encoder feedback

- Incremental encoders with two 5 V complementary signals electrically shifted by 90° (TTL encoders) or HTL encoders can be connected.
- Connection to a 9-pole Sub D socket X5 or X9, depending on the configuration of C005
 - Maximum input frequency: 420 kHz with TTL encoder
100 kHz with HTL encoder
 - Current consumption per channel: 6 mA
- With HTL signal:
 - If there is no inverse track available, the inputs \bar{A} and \bar{B} (with zero track also \bar{Z}) must be connected to the encoder supply potential.

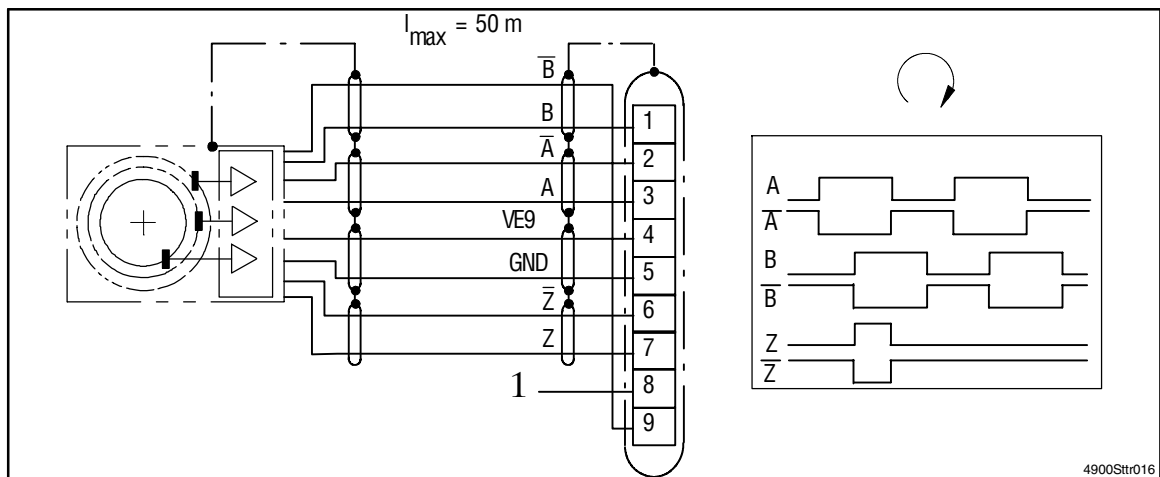
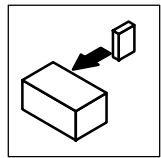

FIG 4-16 Incremental encoder connection (9-pole Sub D socket)

4900Sstr016



Pin assignment of socket X5/X9:

Pin	1	2	3	4	5	6	7	8	9
Signal	B	A	A	VE9	GND	Z	Z	LC	B

Pin 8, LC (①)

- For encoders without lamp control, assign +5 V...+30V. Otherwise, the controller will indicate fault "Sd3" or "Sd4".

Pin 4, VE9

- Is connected to the terminal of the external incremental encoder supply X4/VE9.

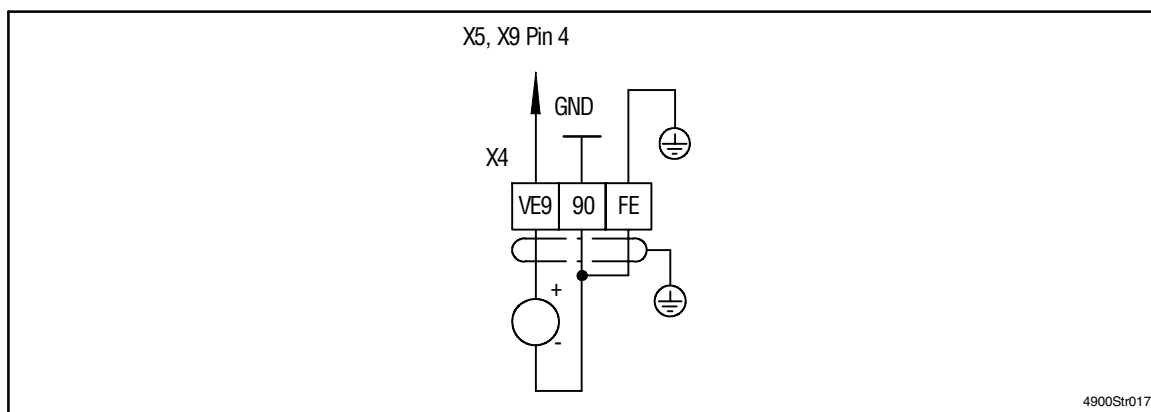

FIG 4-17 Connection of the incremental encoder supply

VE9	External supply for incremental encoder to X5/X9
90	Internal ground GND
FE	Functional earth

4.3.6 Change of the direction of rotation in 2Q operation

In 2Q operation (controller 48XX or C180 = -1-), only one thyristor bridge of the controller is active, i.e. the output terminal A can only carry positive voltage referred to terminal B, on the condition that no active loads occur.

The direction of rotation of the motor is determined by the connection of the armature cable to A and B and of the field cable to I and K. If the opposite direction of rotation is required, take the following steps (depending on the actual value feedback system):

Act. speed feedback system	Direction of rotation changed by:	Additional measures
Armature voltage	Exchange connection: ● Terminals A and B or ● Terminals I and K	None
Tacho		Connection tacho signal exchange term. 3 and 4
Resolver		Signal cable resolver exchange track + sin and -sin
Incremental encoder		Invert act. speed signal via C205 / C027

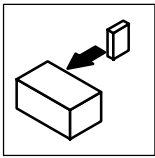

Installation

4.3.7 Digital frequency selection and encoder emulation

Digital frequency input

- Possible digital frequency signals:
 - Incremental encoder with two 5 V complementary signals electrically shifted by 90° (TTL encoders) or HTL encoder
 - Encoder emulation of the host (master)
- Connection to a 9-pole Sub D socket X5 or X9, depending on the configuration of C005
 - max. input frequency: 420 kHz for TTL encoders
 100 kHz for HTL encoders
 - Current consumption per channel: 6 mA

Digital frequency selection via the digital frequency output of the master drive

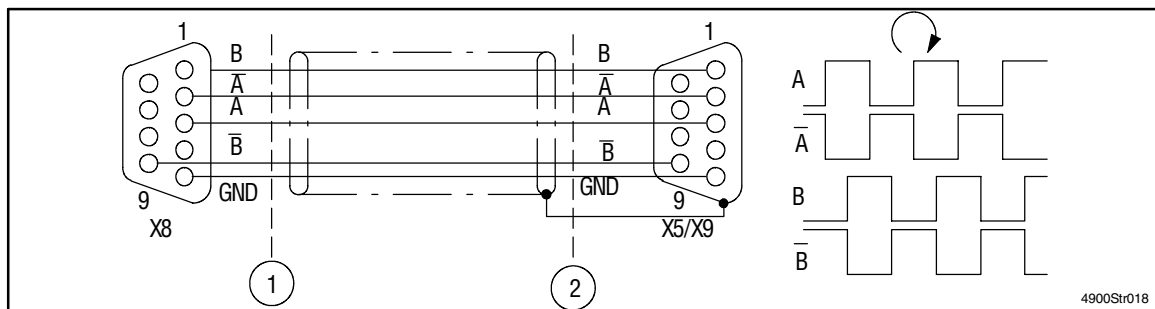

FIG 4-18 Digital frequency selection for the slave ② via digital frequency output (master ①)

Pin assignment of socket X5/X9:

Pin	1	2	3	4	5	6	7	8	9
Signal	6.5	A	A	VE9	GND	Z	Z	LC	B

Pin 8, LC (lamp control of the encoder):

- With digital frequency coupling, pin 8 is deactivated in the factory setting (configuration C005= -5X-, -6X-, -7X-)

Pin 4, VE9

- Is connected to the terminal of the external incremental encoder supply X4/VE9.

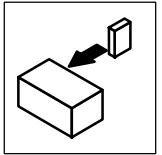

Digital frequency output / encoder emulation

The output signal of the Sub-D socket X8 can be used for superimposed control circuits to feed back actual values (synchronous running, digital frequency coupling or positioning control). Depending on the configuration under C005, it is assigned as a digital frequency output or as an output for the encoder emulation.

Features:

- Two 5V complementary signals (TTL signal), electrically shifted by 90°
- Current capacity 20mA per channel
- Current capacity at PIN 8 (+5V): max. 5mA

The output signal is internally derived from the resolver or incremental encoder signal.

	Resolver feedback	Incremental encoder feedback
Resolution	2048 increments per revolution	Constant of the incremental encoder
Signal type		

FIG 4-19 Signal of digital frequency or encoder output X8 assignment of plug X8

Pin assignment of socket X8:

Pin	1	2	3	4	5	6	7	8	9
Signal	B	A	A	NC	GND	Z	Z	+5V	B



Note!

If fault messages occur at the encoder monitoring during resolver feedback to superimposed systems:

- Exchange tracks A and B
- Use inverse tracks

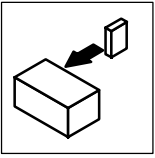

Installation

4.3.8 Serial interface RS232/485



Danger!

The interface RS232C/RS485 is not isolated, i.e. an additional electrical isolation (double basic insulation) to VDE 0106, part 1, (protection against electric shock) and to VDE 0160 (reduction of interference) is required for host connection.

LECOM-A: with 2 Lenze level converters 2101IB connected to the host or another RS 232C electrical isolation.

LECOM-B: with Lenze level converter 2101IB connected to the host

LECOM-LI: no additional electrical isolation required

Ensure electrical isolation of the voltage supply!

The controllers can communicate with the host (PLC or PC) via the serial interface LECOM1 or an operating keypad that works according to the LECOM protocol.

The LECOM1 interface (X6) processes the LECOM-A/B protocol. The LECOM-A/B protocol is based on the standard ISO 1745 and can be used with up to 90 controllers. It detects faults and avoids the transmission of faulty data.

Controllers to standard RS232C (LECOM-A) or RS485 (LECOM-B) can be connected to the LECOM1 interface. The interface can be used for parameter setting, monitoring, analysis and simple control tasks.

With the RS232C interface, it is possible to create point-to-point connections with a cable length of up to 15 m. Most PCs or other hosts are equipped with this interface.

For multiple drives and distances > 15m, use the RS485 interface. With only 2 wires it is possible to connect up to 31 controllers and communicate over a cable length of max. 1,200 m.

Pin assignment of socket X6:

Pin	Name	Input/output	Explanation
1	+VCC15	Output	Supply voltage + 15V / 50mA
2	RxD	Input	Receive data cable RS232C
3	TxD	Output	Transmit data cable RS232C
4	DTR	Output	Transmission control RS232C
5	GND		Controller reference potential
6	DSR	Input	(not used) RS232C
7	T/R (A)	Output/input	RS485
8	T/R (B)	Output/input	RS485
9	+VCC5	Output	Supply voltage +5V

The baud rate can be changed under C125 (1200/2400/4800/9600 baud).

Protocol: LECOM-A/B V2.0

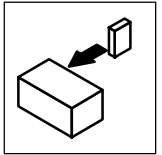

4.3.9 Fieldbus connection



Note!

Special features of the controller variants V011 and V013:

1. The interface module 2110IB or 2130IB is integrated into the controller.
2. In the factory setting, the controllers are prepared for the separate mains supply of power stage and control electronics:
 - The bridges BR3, BR4, BR5 are not installed!

- Variant V011 with InterBus interface module

The interface module type 2110IB connects Lenze controllers with the fast serial communication system InterBus. The module enables the highly dynamic transfer of process data (e. g. setpoints and actual values) and access to all parameters of the controller according to the DRIVECOM profile.

The InterBus communication is based on a ring concept. All bus participants are required for communication. For applications which require a volt-free power stage, a separate mains supply must be provided to ensure communication (see chapter 4.3.3).

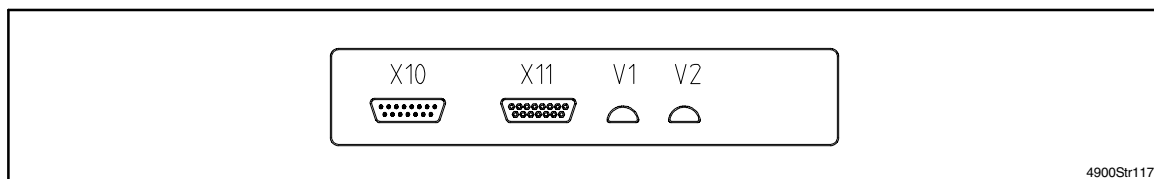
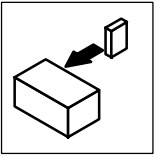

FIG 4-20 Front view 2110IB

X10	Input InterBus peripheral bus
X11	Output InterBus peripheral bus
V1	LED green, bus supply
V2	LED yellow, communication



Installation

- Variant V013 with PROFIBUS interface module

The interface module type 2130IB connects Lenze controllers to the fast serial communication system PROFIBUS. With PROFIBUS it is possible to parameterize and control a controller via a host.

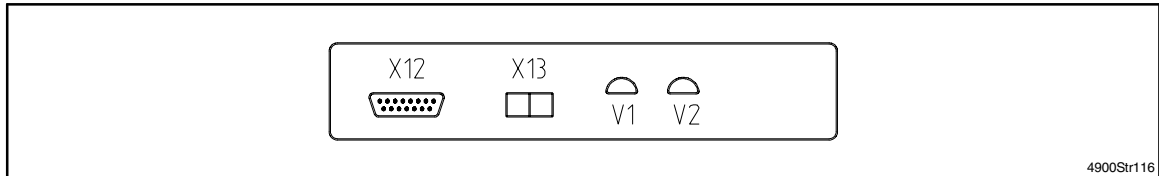
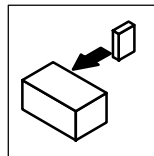

FIG 4-21 Front view 2130IB

Connection	Explanations	
X12	RS485 bus connection	9-pole SubD socket
X13-W30	Optical fibre receiver	(only 2130IB, V002)
X13-W31	Optical fibre sender	(only 2130IB, V002)
V1	2130IB supply	OFF: Module is not supplied. Controller is switched off or connection is interrupted(X4). ON: Module is supplied.
V2	Communication 2130IB	OFF: No supply or 2130IB and controller not yet initialised. ON: Module 2130IB and basic unit are initialised but the PROFIBUS-DP communication is still not working. FAST BLINKING (4x per second): PROFIBUS-DP communication with user data SLOW BLINKING (1x per second): PROFIBUS-DP communication initialised

If the interface module 2130IB is no longer supplied, the bus system will not stop working. However, the connected controller cannot be addressed by the host.

If necessary, the control stage of the controller should be supplied separately (see chapter 4.3.3).



4.4 Installation of a CE-typical drive system

4.4.1 General notes

- The electromagnetic compatibility of a machine depends on the type of installation and care taken. Please observe:
 - Assembly
 - Filters
 - Screening
 - Grounding
- For diverging installations, the conformity to the CE EMC Directive requires a check of the machine or system regarding the EMC limit values. E.g. with:
 - the use of unscreened cables
 - the use of group RFI filters instead of the assigned RFI filters
 - Operation without mains choke
 - Multi-motor drive systems

The user of the machine is responsible for compliance with the EMC Directive.

If you observe the following measures, you can assume that the machine will operate without any EMC problems caused by the drive system, and that compliance with the EMC Directive and the EMC law is achieved.

If devices which do not comply with the CE requirement concerning noise immunity EN 50082-2 are operated close to the controller, these devices may be interfered electromagnetically by the controllers.

Because of the earth-potential reference of the RFI filters, the CE-typical drive systems which are described are not suitable for the connection to IT-mains (mains without earth-reference potential).

For the use of 48XX/49XX drive systems in residential areas observe the following:

- Check that the radio interference suppression level at the supply to the site of operation complies with the standard (EN55022 class B).
- Check that the permissible level for radio interference (EN55022 class B) is not exceeded around the site of operation.

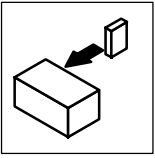

Installation

4.4.2 Components of the CE-typical drive system

System component	Specification
Controller	4800/4900 DC controllers
RFI filter	For data and filters see chapter 13.4
Mains choke	For assignment and technical data see chapter 13.2
Armature and field cable	Unscreened power cable Rated max. length: 50m
Control cables	Screened signal cable type LIYC
Encoder cable for digital frequency	Lenze system cable or screened signal cable, twisted in pairs, tin plated E-CU braid with 75% optical overlay
Encoder cable for resolver	Lenze system cable type EMLR or screened signal cable, twisted in pairs, tin plated E-CU braid with 75% optical overlay
Motor	Separately excited DC motor Lenze series MGFQ, MGFR or similar
Accessories	InterBus module 2110IB Profibus module 2130IB

Controller, RFI filter and mains choke are mounted on the same assembly board inside a standard control cabinet.

4.4.3 Measures required

Control cabinet assembly board

- For HF grounding, only use mounting plates with an excellent conductive surface (e.g. zinc-coated surface).
- If you use mounting plates with badly conductive surfaces (e.g. painted, anodized, yellow passivated):
 - Remove the paint or coating from the contact surface of the mains filters, controllers, and screen connections, to provide a large and conductive connection.
- When using several mounting plates, connect them with a surface as large as possible (e.g. using copper bands).
- Connect the controller, RFI filter and mains choke to the grounded mounting plate with a surface as large as possible.

Power connection

- Avoid unnecessarily long cables
- Ensure the separation of motor cable and signal or mains cable.
- Ensure separation of unscreened and screened cables (distance > filter length)
- Ensure a distance as short as possible between the conductors (single-cores)
- Both ends of unused cores should be connected to ground/PE.

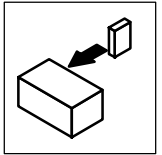

Signal cables

- Always screen digital and analog signal cables.
 - Always connect the signal cables over the shortest possible distance with the screen connections provided at the controller:
 - Connect both screen ends of digital signal cables.
- If potential differences are to be expected, lay an additional compensation cable.
- For long signal cables, provide additional screening points:
 - Connect the screen at the control cabinet input with a suitable clamp to the conductive mounting plate of the control cabinet.

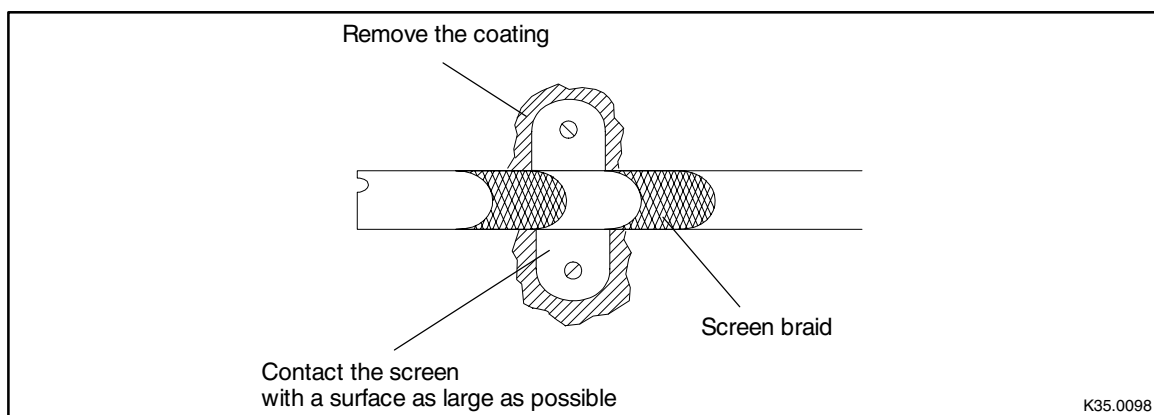

FIG 4-22 Additional screening connection on a mounting plate of the control cabinet

Filters

- Only use the mains filters and RFI filters which are designated for the controller:
 - RFI filters reduce impermissible high-frequency interference to a permissible value.
 - Mains chokes reduce low-frequency interference which depend on the motor cable and its length.

Screening

Wire the screening and the GND and PE connections very carefully, to avoid interference.

- All signal cables should be screened.
- Avoid a common terminal board for mains input and motor output.
- Route cable as close as possible to the reference potential. Free-hanging cables have the same effect as aerials.

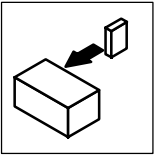

Installation

Grounding

- Ensure a good equipotential bonding of all system parts (controller, RFI filter, mains choke, etc.) by cables to a central earthing bus (PE busbar). The prescribed minimum cross-sections must be observed in all cases.
- To comply with the EMC Directive, not the cross-section but the contact surface is decisive.
- Ensure that grounding of the control electronics does not cause any damage to external controllers.

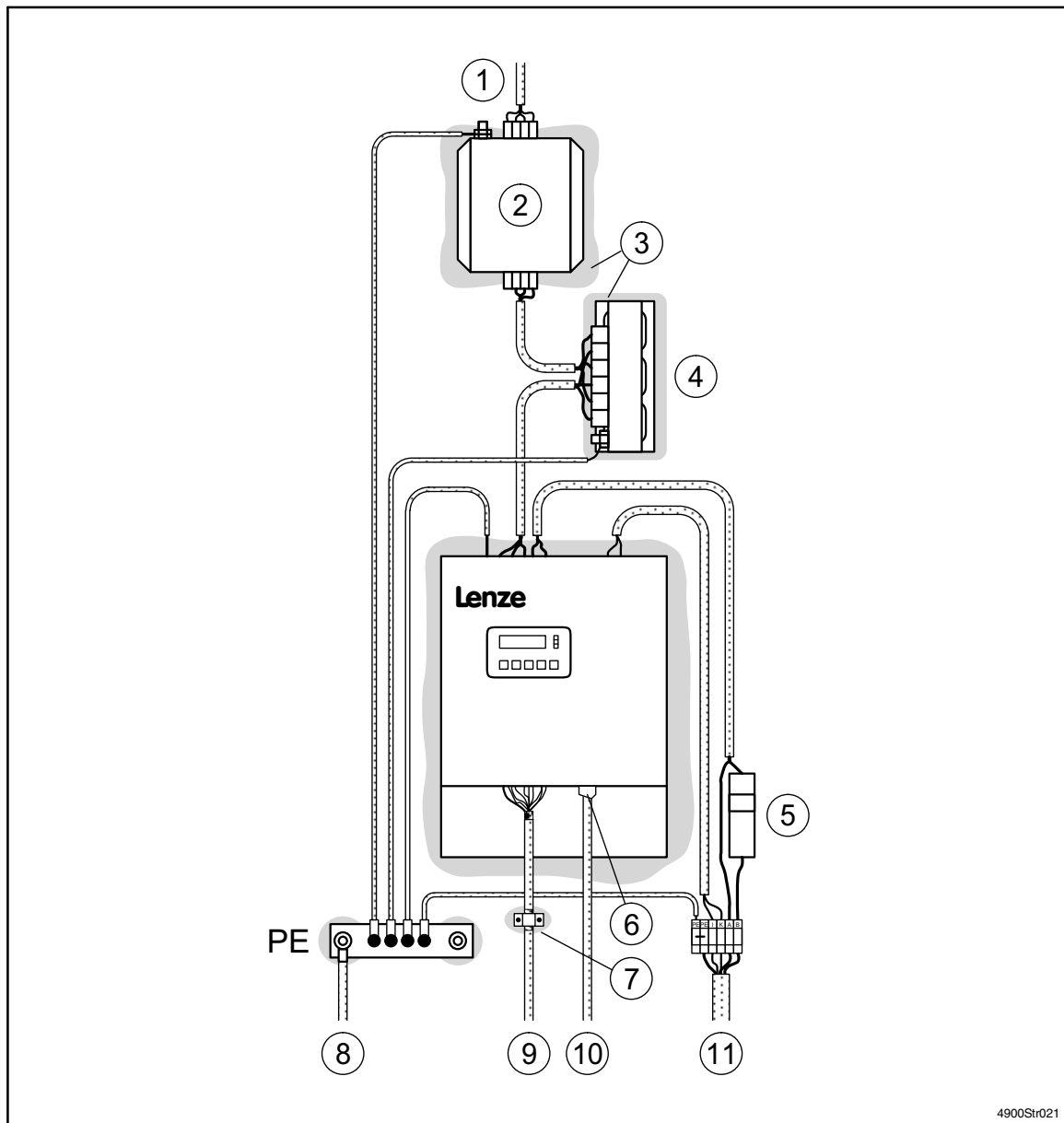
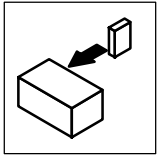

4900Str021

FIG 4-23 Part of the CE-typical drive system with 4902 ... 4907 on a mounting plate

- 1 Connection mains fuse
- 2 RFI filter
- 3 Uncoated, bare metal contact surfaces
- 4 Commutating choke
- 5 Armature fuse
- 6 Metal plug-in casing connected to screen or Lenze system cable
- 7 Uncoated surface for screen connection
- 8 PE connection
- 9 Screened signal cables
- 10 Screened cables for act. value encoder or setpoint encoder
- 11 Motor connection

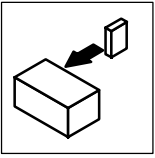

Installation

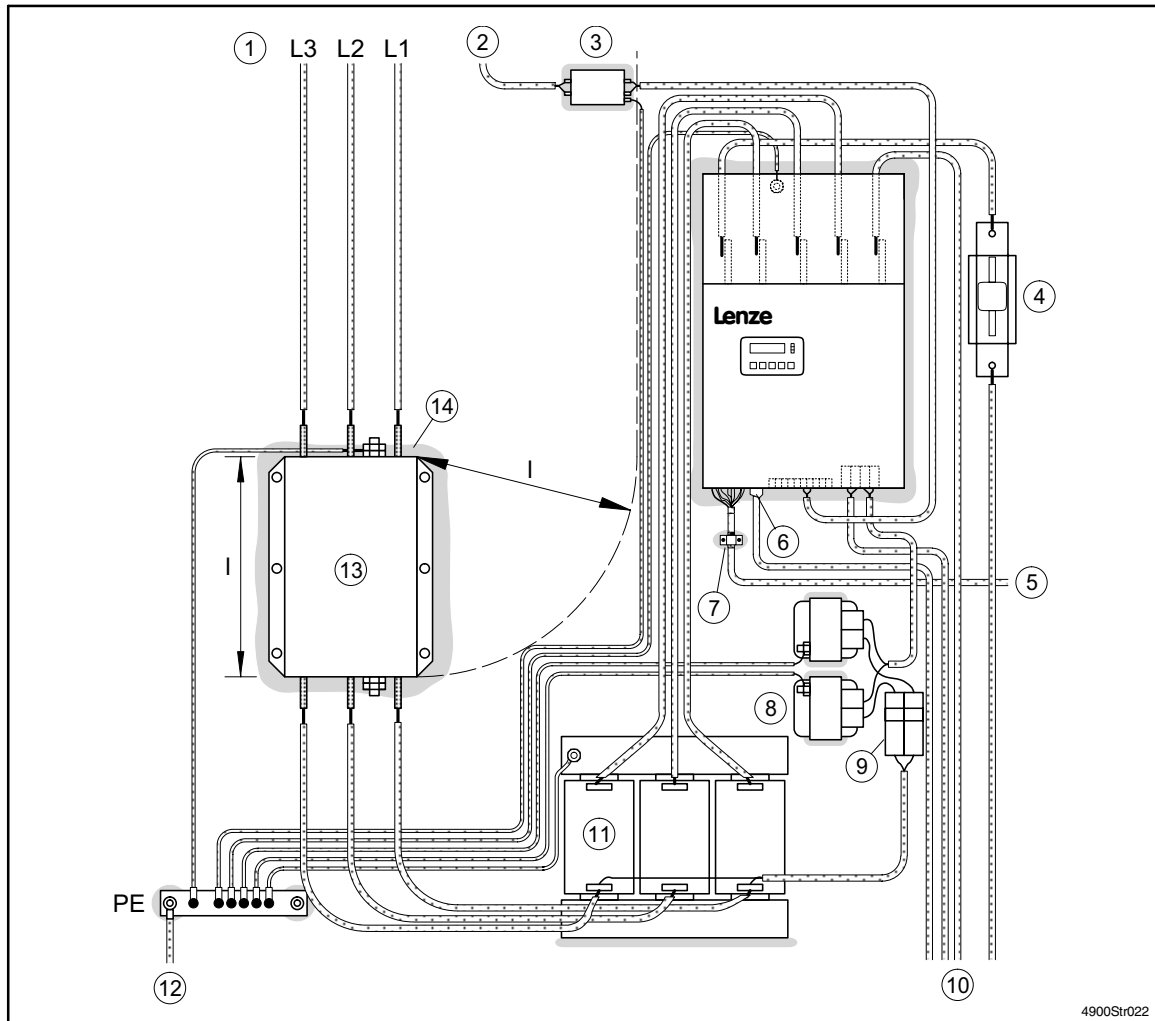
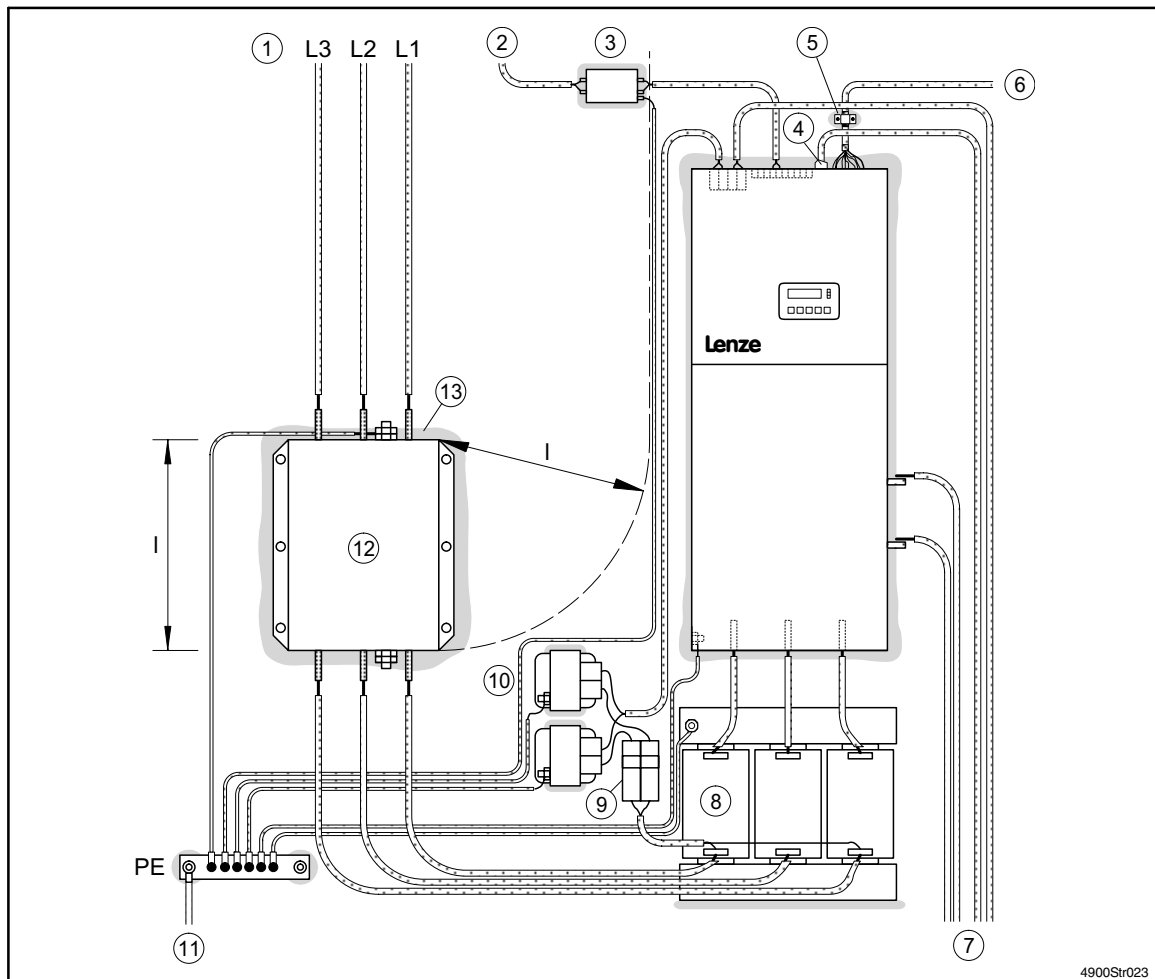
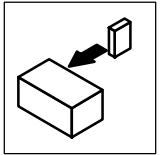

FIG 4-24 Part of the CE-typical drive system with 4X08/4X09 on a mounting plate

- 1 Connection mains fuse
- 2 Connection fan supply L1/N
- 3 RFI filter
- 4 Armature fuses
- 5 Screened signal cables
- 6 Metal plug-in casing connected to screen or Lenze system cable
- 7 Uncoated surface for screen connection
- 8 Mains choke field supply
- 9 Line protection fuses for field supply
- 10 Motor connection with screened cable for act. value encoder
- 11 Commutating choke
- 12 PE connection
- 13 RFI filter
- 14 Uncoated, bare metal contact surfaces



4900Str023

FIG 4-25 Part of the CE-typical drive system with 4X11 ... 4X13 on a mounting plate

- 1 Connection mains fuse
- 2 Connection fan supply L1/N
- 3 RFI filter
- 4 Uncoated surface for screen connection
- 5 Metal plug-in casing connected to screen or Lenze system cable
- 6 Screened signal cables
- 7 Motor connection with screened cable for act. value encoder
- 8 Commutating choke
- 9 Line protection fuses for field supply
- 10 Mains choke field supply
- 11 PE connection
- 12 RFI filter
- 13 Uncoated, bare metal contact surfaces

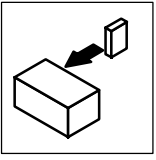

Installation

EDS4900U--C
00408852

Manual

Part C

Commissioning

DC speed controller
4800/4900

The features, data and versions indicated in this Manual met the state of the art at the time of printing.

(Printing date: inner cover pages of the parts).

In the event of deviations, please see the Operating Instructions or contact Lenze.

		revised	
Edition of:	01/03/1999		

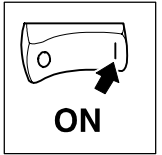

5 Commissioning

5.1 Initial switch-on



Stop!

Prior to initial switch-on of the controller, check the wiring for completeness, short-circuit, and earth fault:

- Power connection:
 - Supply via terminals L1, L2 and L3
 - Separate field supply (if available)
- Field connection
- Armature connection
- Feedback system (resolver, incremental encoder,)
- Control terminals:
 - Controller enable: Terminal X2/28 (reference potential: X2/39)
 - Selection of direction of rotation Terminal X2/21 or X2/22 (reference potential: X2/39)
 - Setpoint selection
 - with internal voltage supply: bridge between X2/39 and X3/40
- **Maintain the switch-on sequence!**



Note!

- All controllers described are factory set. A DC shunt motor with attached tacho can be driven as a speed-controlled drive with tacho feedback without further settings after entering the rated field current (see nameplate). The motor must comply with the following:
 - $V_{\text{mains}} = 420\text{V}$
 - $n_{\text{rated}} = 3000 \text{ rpm}$
 - $V_{\text{tacho}} = 20\text{V} / 1000 \text{ rpm}$
- Simple adaptation to other machine data or special requirements: Use the following for commissioning:
 - Operating unit of the controller or
 - LEMOC2 (PC program by LENZE)

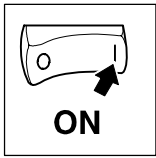

Commissioning

Wiring recommendation for speed control with tachometer

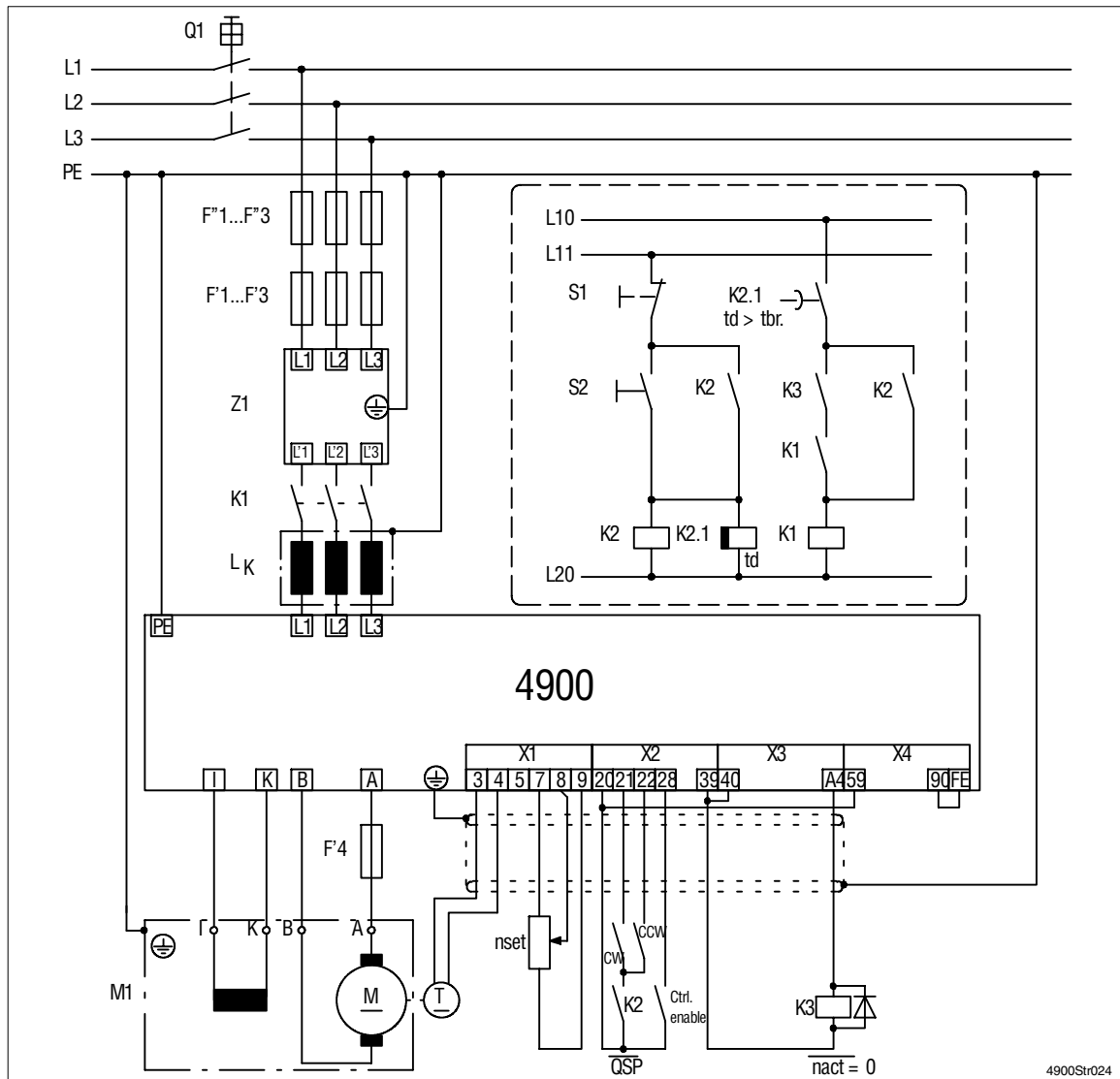
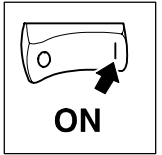

FIG 5-1 Flow chart section: Speed control with tachometer

F*1...F*3	Cable protection fuse	L11	"Emergency stop" cable
F'1...F'3	Semiconductor fuse	LK	Mains choke
F'4	Armature fuse	M1	Motor
K1	Mains contactor	nset	Setpoint potentiometer
K2	QSP relay	CW	CW rotation
K2.1	Delay timer	Ctrl. enable	Controller enable
K3	Motor standstill	Q1	Main switch
CCW	CCW rotation	QSP	Quick stop function
L10	Direct cable from the control cable "ON"	Z1	RFI filter

With a tachometer voltage to ground: bridge terminals X1/4 and X1/5 and configure the switch S4 on the control module for the operation with a tachometer signal to ground (chpt. 4.3.4.1).



The following table describes briefly how to commission a DC shunt motor with an attached tacho according to the example in FIG 5-1 (see chapter 15).

Section	Activity	see also
Switch-on sequence	<p>1. X2/28 (Ctrl. enable) must be opened (LOW)</p> <p>2. Connect the mains Approx. 0.5sec after mains connection the controller is ready for operation. The time t_1 depends on the initial response of the field current</p> <p>Typical values: $t_1 = 300\text{ms} \dots 600\text{ms}$ $t_2 = t_1 + 20\text{ms}$</p> <p>FIG: Signal flow after mains connection (see fig. on the right)</p>	<p>4900Str025</p>
Input of the motor data	<p>3. Input of the motor nameplate data</p> <ul style="list-style-type: none"> - C083 Rated field current - C084 Armature circuit time constant - C088 Rated motor current - C090 Rated motor voltage 	Chapter 5.2
adaptation of tacho constants	<p>4. Set S4 before adapting the tacho voltage</p> <ul style="list-style-type: none"> - C025 -2- Select adjustment of terminals 3, 4 - C029 Adjustment of actual speed 	Chapter 7.1.2.2
Set the current limit	<p>5. Max. motor current</p> <ul style="list-style-type: none"> - C022 $+I_{Amax}$ - C023 $-I_{Amax}$ 	
Adjustment of max. speed	<p>6. Select the reference value for 100% setpoint</p> <ul style="list-style-type: none"> - C011 max. speed 	
Select direction of rotation	<p>7. CW rotation: HIGH signal at X2/21 (+13...+30 V) CCW rotation: HIGH signal at X2/22 (+13...+30 V)</p>	Chapter 5.4
Setpoint selection	<p>8. Apply a voltage higher than 0V (max. 10V)</p> <ul style="list-style-type: none"> - do not activate JOG setpoint (LOW signal at X2/E4 and X2/E5) 	
Check whether LED 'RDY' is on	<p>9. If RDY is off and C067 is blinking, remove TRIP first.</p>	Chapter 8.1 ff.
Controller enable	<p>10. Assign HIGH-signal to X2/28 (+13...+30 V) and do not press STP</p> <p>The motor will now run with the selected setpoint and in the selected direction of rotation. If necessary, adapt the controller to your application.</p>	Chapter 5.3
Additional settings	<p>11. Further setting required for LECOM operation</p>	



Stop!

- Do not change the switch-off sequence

The controller must only be disconnected from the mains when it is inhibited or the motor is in standstill (for mains switch-off logic see chapter 15.9.2).

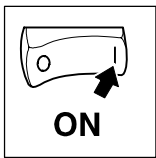

Commissioning

5.2 Input of the motor data



Note

For internal calculations with field-weakening control, the exact input of the following data is required. See indications on the nameplate of the connected motor.

- C022, C023 Adapt maximum motor current I_{\max}
- C081 Rated motor power for the power display
- C087 Rated motor speed for the power display
- C083 Rated field current for the field controller
- C084 L/R armature time constant for uncompensated motors
- C088 Rated motor current for "I² t monitoring" (armature circuit)
- C090 Rated motor voltage for armature voltage limitation

Under C084 the controller can be adjusted to different armature time constants $T = L/R$. The values can be set between 0 ms and 30 ms.

Common armature time constants: (see motor catalog, section I)

- compensated machines 0 ms to 10 ms
- uncompensated machines 15 ms to 30 ms.

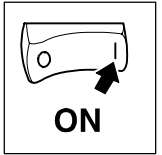

5.3 Controller enable

For controller enable, the following conditions must be fulfilled:

- Controller enable via terminal:
 - Independently of the operating mode, apply a voltage of $V = +13...+30\text{ V}$ to X2/28. (Reference potential: X2/39).
- Controller enable via LECOM interface
 - For the operating modes C001 = -3-, -5-, -6- and -7- (LECOM control), the controller must be additionally enabled via the LECOM interface.
- Stop function
 - The controller can be inhibited by pressing the STP key. The stop function can only be reset via the enable command SH + STP or mains switching.
- TRIP reset
 - If a monitoring system sets TRIP the controller will be inhibited immediately. The internal controller inhibit will be reset when resetting the fault (C067).

Since the controller inhibit can be caused by many different reasons, the origin of the controller inhibit is displayed under C183.

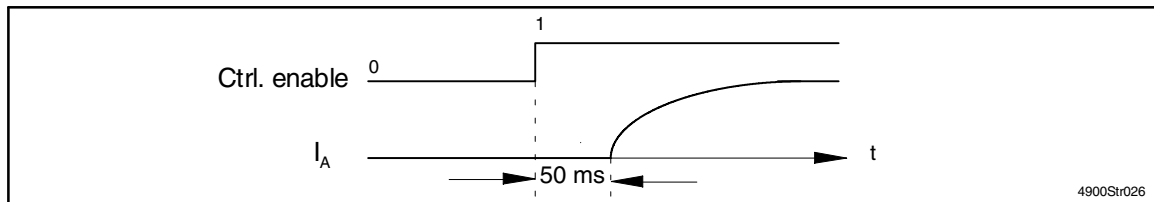
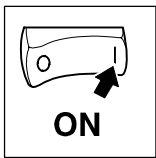

FIG 5-2 Signal flow when enabling the controller



5.4 Selection of direction of rotation and quick stop

Direction of rotation

The polarity of the output voltage V_A and thus the direction of rotation of the motor depends on the signs of the setpoint, the control of the digital inputs X2/21 and X2/22, and the polarity of the field voltage.

Quick stop (QSP)

Independently of the setpoint selection and because of the quick stop function, the controller can be stopped within a time selectable under C105.

- The quick stop function is active:
 - when the mains is switched on, if X2/21= HIGH and X2/22 = HIGH
 - during operation with X2/21 = LOW and X2/22 = LOWThe speed is reduced to zero within the deceleration time set under C105.
- Quick stop
 - sets the additional setpoint integrator to 0.
 - decelerates the drive to 0 according to the deceleration ramp set under C105.
 - is detected internally if no signal has been applied to X2/21, X2/22 for more than approx. 6 ms.
- The drive starts running again
 - if a HIGH signal is applied to one of the inputs (also for keypad or interface operation).

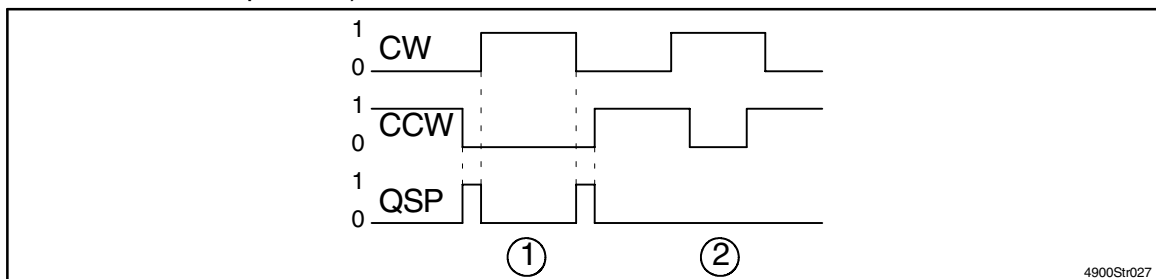
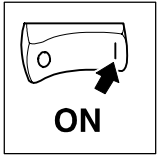

FIG 5-3 Selection of direction of rotation

- ① CW/CCW not overlapping
- ② CW/CCW overlapping

When the threshold $n_{act} = 0$ (C019) is reached, the integral action component of the speed controller will be switched off (only if C005 = -10-, -11-, -40-, -41-). With all other configurations, the I-component of the n-controller will only be switched off, if the angle controller is not active (C254 = 0). The drive cannot generate a torque when stopped by a brake.



With the configurations C005 = -X2- or -X3- and activated angle controller (C254 > 0), the drive will be decelerated to speed = 0 and angle-controlled (drift-free). The drive can thus generate its maximum torque (independently of the current limit C022, C023).

Code	Name	Possible settings				Info
		Lenze	Selection			
C105	Deceleration time for quick stop	0.00s	0 s 1 s 10 s 100 s	{0.01 s} {0.1s} {1 s} {10 s}	1 s 10s 100 s 990 s	Time referred to the speed change 0...n _{max}

- Configuration possibilities for the selection of the direction of rotation and quick stop

Operating mode	Setpoint to X1/8	X2/21	X2/22	C041	C042	Direction of rotation (View towards motor shaft)
Terminal control	positive	HIGH	LOW	-0-	-0-	cw
	negative	LOW	HIGH	-1-	-0-	
C041 and C042 display the status of terminals X2/21 and X2/22	positive	LOW	HIGH	-1-	-0-	ccw
	negative	HIGH	LOW	-0-	-0-	unchanged
	pos. / neg.	HIGH	HIGH	-0- / -1-	-0-	
Keypad / LECOM C041 and C042 determine the direction of rotation or quick stop, in addition LOW signal X2/21 and X2/22 activates quick stop.	positive	HIGH/LOW	LOW/HIGH	-0-	-0-	cw
	negative	HIGH/LOW	LOW/HIGH	-1-	-0-	
	positive	HIGH/LOW	LOW/HIGH	-1-	-0-	ccw
	negative	HIGH/LOW	LOW/HIGH	-0-	-0-	
	pos. / neg.	LOW	LOW	-0- / -1-	-1-	Quick stop active

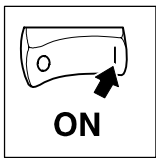

5.5 Changing the internal control structure

The internal control structure is adapted to the control task (e. g. speed control, torque control, angle control,) via code C005 (see chapter 7.9). The controller must however be inhibited first.



Stop!

It is possible that the terminal assignments change when the internal control structure is changed.

5.6 Changing the terminal assignment



Note!

A function, which is already assigned to an input, can only be assigned to another terminal if the input used before is assigned with a new function. If you reassign an input, the function assigned before will be overwritten.

Freely assignable digital inputs

Except for the functions "Enable JOG setpoints", "Enable additional acceleration and deceleration times", "Enable fix setpoints" and "Select parameter set", each function can only be assigned to one input.

It is possible to determine a priority for each input:

The function can either be switched via a terminal, or depending on the selected operating mode.

Changing the assignment

1. Select the input to be assigned under C112.
2. Select the function for the input under C113.
3. Determine the polarity under C114 (HIGH-active or LOW-active).
4. Determine the priority under C115.

Repeat steps 1. to 4. to assign all inputs.

5 freely assignable inputs are available at the terminals.

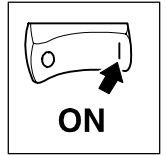

Freely assignable digital outputs

The controller provides 12 freely assignable digital outputs and a relay output.

The free digital outputs 1 to 5 are assigned to terminals X3/A1 to X3/A4 and X4/A5. The relay output is assigned to terminals X3/K11 and X3/K14. The polarity can be determined (HIGH-active, LOW-active) and the output can be delayed.

The free digital outputs 6 to 12 can only be evaluated via the LECOM interface. They are always HIGH-active.

Changing the assignment

1. Select the output to be assigned under C116.
2. Select the function for the output under C117.

Only for outputs A1 to A5 and relay output:

3. Determine the polarity under C118 (HIGH-active or LOW-active).
4. Determine the signal delay under C128.

Repeat steps 1. to 4. until all outputs are assigned.

Freely assignable "analog" inputs

The term "freely assignable analog inputs" comprises the analog (terminals) and digital (X5, X7 and X9) setpoint and actual value inputs.

If you change the configuration under C005, the assignment of the free analog inputs will be overwritten with the corresponding factory setting. If necessary, adapt the function assignment to the wiring.

It is possible to determine the priority for terminals X1/1, X1/2, X1/3, X1/4, X1/6, X1/8, X5, X7 and X9. Thanks to the priority function, the terminal can be switched independently of the the operating mode.

Changing the assignment

1. Select the input to be changed under C145.
2. Select the function for the input under C146.

Only for inputs X1/1, X1/2, X1/3, X1/4, X1/6, X1/8, X5, X7, X9:

3. Determine the priority under C147.

Repeat steps 1. to 3. until all inputs are assigned.

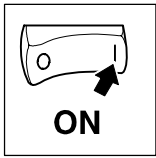

Commissioning

Freely assignable analog monitor outputs

Via the monitor outputs X4/62, X4/63 und X8, internal signals can be output as voltage signals, current signals or frequency signals (See chapter 4.3.4.1).

With C108 and C109 (C109 is not effective for the digital frequency output), the outputs can be adapted, for instance, to a measuring unit or a slave drive.

Changing the assignment

1. Select the output to be assigned under C110.
2. Select the function for the output under C111.
3. Set the offset under C109 (not for the digital frequency output).
4. Determine the gain under C108.

Repeat steps 1. to 4. until all outputs are assigned.

Special feature of the freely assignable digital frequency output

With the selection of a configuration under C005, the output X8 already has a basic assignment. The assignment can only be changed afterwards.

If the digital frequency output X8 is assigned to another signal than indicated in the basic assignment of the configuration (C005), then the output frequency can only be adapted via code C108.

With signal sources with a reference value of 100% (see C111, except: DF and resolver inputs) a signal of 100% at the output X8 with a gain factor of $C108 = 1.00$ corresponds to a frequency of 250 kHz.

Commissioning

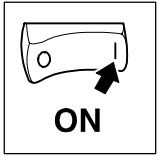

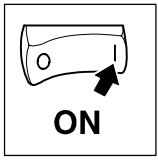

Commissioning

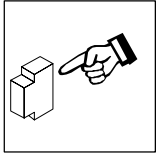

6 During operation

This chapter is part of the Lenze documentation structure.
It remains free for the 48XX/49XX DC speed controller.

EDS4900U-D
00408853

Manual

Part D

Configuration

Code table

DC speed controller
4800/4900

The features, data and versions indicated in this Manual met the state of the art at the time of printing.

(Printing date: inner cover pages of the parts).

In the event of deviations, please see the Operating Instructions or contact Lenze.

		revised	
Edition of:	01/03/1999		

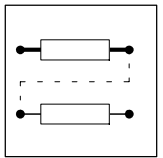

7 Configuration

7.1 Speed controlled operation

For standard applications, the drive can be immediately commissioned with the default settings. To adapt the drive to special requirements, please observe the notes in the following chapters.

7.1.1 Set-valueselection

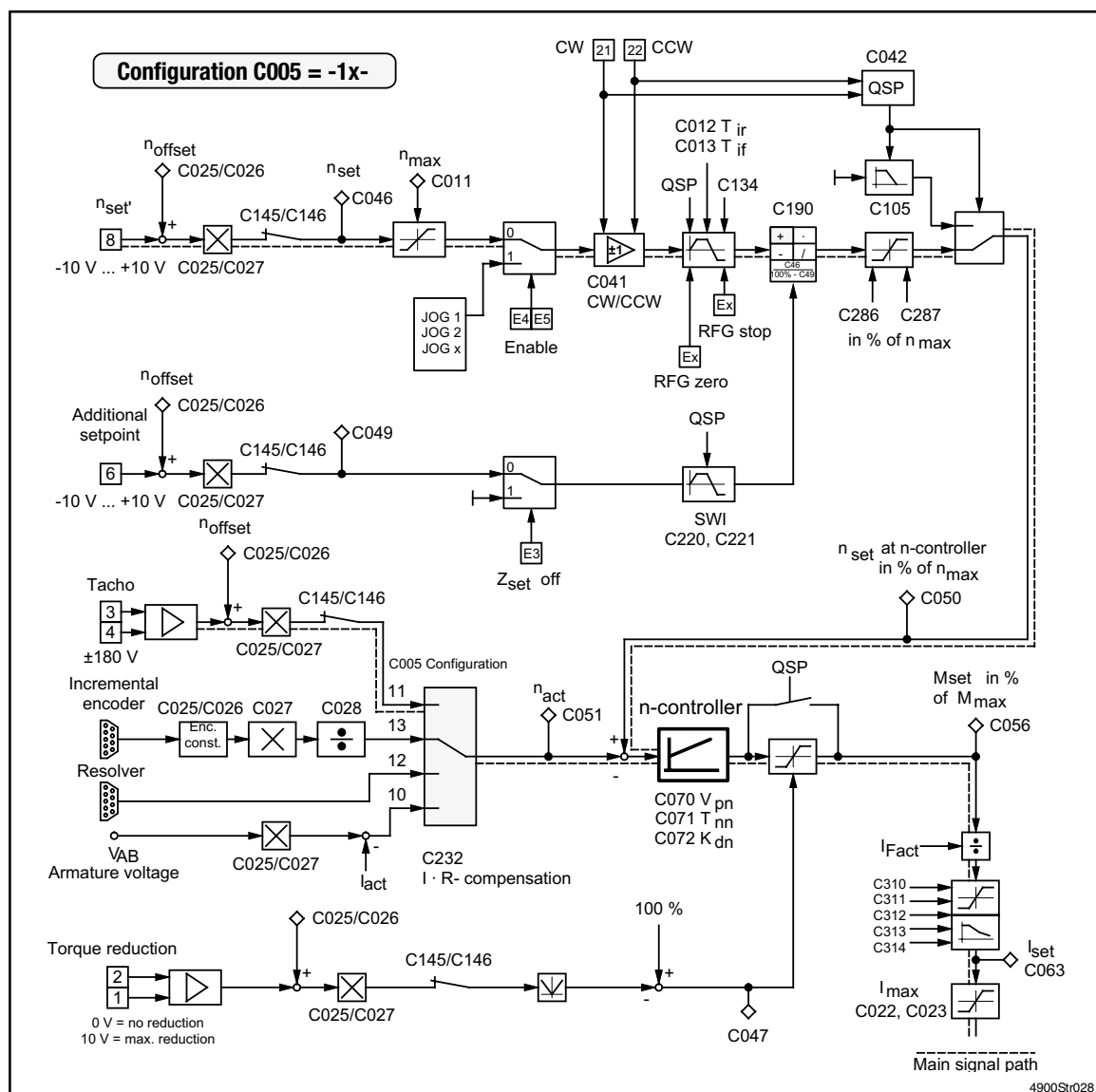
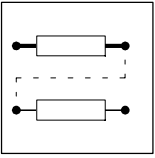

FIG 7-1 Signal-flow chart showing the set-value processing for speed control with addition setpoint (C005 = -1X-) default setting



Configuration

7.1.1.1 Main set-value

The speed is determining via via the set-value n_{set} (C046) and related to the adjustable value n_{max} (C011). The set-value can be selected as analog value using the input X1/8, as dig. frequency using X5 or X9, as well as via keypad or LECOM interface. Which input is activated depends on the operating mode set under C001 and the signal priority set under C145/C147. The set-value channel is determined via the configuration. A change to other signal sources is possible via the codes C145 / C146.

7.1.1.2 Additional set-value

Also with keypad or interface operation, the additional analog set-value can be set via the input X1/6 (or another signal source). The additional set-value (C049 / set-value 2) is internally sent to a ramp function generator before it is combined with the main set-value in a "fixed" arithmetic block. The additional set-value can be switched off via X2/E3 (C280).

With this function it is possible, for instance, to deactivate a correction signal during set-up (dancer position, etc.).

Code	Name	Possible settings				Info
		Lenze	Selection			
C220*	Acceleration time T_{ir} of the additional set-value	0.00 s	0.00 s 1 s 10 s 100 s	{0.01 s} {0.1 s} {1 s} {10 s}	1 s 10 s 100 s 990 s	
C221*	Deceleration time T_{if} of the additional set-value	0.00 s	0.00 s 1 s 10 s 100 s	{0.01 s} {0.1 s} {1 s} {10 s}	1 s 10 s 100 s 990 s	

7.1.1.3 JOG set-values

If you need certain fixed settings as main set-values, it is possible to retrieve set-values, which can be parameterised, from the memory using the JOG inputs. JOG set-values replace the main set-value. Enter JOG set-values as relative values in % of n_{max} .

Parameter setting for JOG set-values

JOG set-values are set in two steps:

- Select a JOG set-value under C038.
- Enter the value selected for the JOG set-value under C039.

Repeat these two steps if you need several JOG set-values. Up to max. 15 JOG set-values can be programmed.

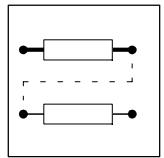

Code	Name	Possible settings		Info
		Lenze	Selection	
C038	Input preselection: JOG set-value	1	-1- Selection JOG1 -2- Selection JOG2 ... -15- Selection JOG15	Select JOG setpoint to be set under C039.
C039	JOG speed for C038		-100 % n_{max} {0.1 %} 100.0% JOG1 75.0% JOG2 50.0% JOG3 25.0% JOG4 0.0 % JOG5 .. 0.0 % JOG15	+ 100.0 % n_{max} Enable JOG set-values via the digital inputs or via C045.

Assignment of the digital inputs

The number of inputs to be assigned with the function "enable JOG set-value", depends on the number of JOG set-values required.

Number of JOG set-values required	Number of inputs required
1	at least 1
2...3	at least 2
4...7	at least 3
8...15	4

This function can be assigned to up to four inputs.
For input assignment, observe the notes in chapter 5.6.

JOG set-value enabling with terminal control

The assigned digital inputs must be controlled according to the table below to enable JOG set-values.

		2. input	3. input	4. input
JOG 1	1	0	0	0
JOG 2	0	1	0	0
JOG 3	1	1	0	0
JOG 4	0	0	1	0
JOG 5	1	0	1	0
JOG 6	0	1	1	0
JOG 7	1	1	1	0
JOG 8	0	0	0	1
JOG 9	1	0	0	1
JOG 10	0	1	0	1
JOG 11	1	1	0	1
JOG 12	0	0	1	1
JOG 13	1	0	1	1
JOG 14	0	1	1	1
JOG 15	1	1	1	1

The input with the lowest figure is the first input, the input with the next higher figure is the second input, and so on (e. g. E4 = 1. input, E5 = 2. input).

C045 indicates the active set-value.

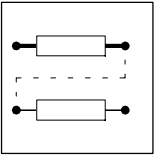

Configuration

JOG set-value enabling with control via keypad or LECOM interface

Active the JOG set-values under C045.

Code	Name	Possible settings		
		Lenze	Selection	Info
C045	JOG enable	0	-0- Main set-value (C046) active -1- Set-value JOG1 active ... -15- Set-value JOG15 active	With terminal control only display

7.1.1.4 Master current

If the analog set-value is to be entered via X1/8 as master current, the current setting range can be selected under C034:

- For -20mA...+20mA: C034 = -0-
- For 4...20mA: C034 = -1- (only unipolar)

If range 4...20mA is selected and the current is less than 2mA, the fault "Sd5" is indicated.

Spannungsleitwert auf Stromleitwert (Strombürde 250) mit dem Schalter S3/1 auf der Steuerbaugruppe 4902MP umschalten:

- Master voltage/potentiometer: S3/1 = OFF
(Default setting)
- Master current: S3/1 = ON
(see chapter 4.3.4)

7.1.1.5 External torque reduction

With a potentiometer, it is possible, for instance, to apply a voltage externally to terminal 2. This voltage has a direct influence on the I_{max} values set under C022 and C023.



Note!

A voltage of 0V at terminal X1/2 corresponds to I_{max} if C005 = -1X-, -5X-, -6X- or -72-.

The corresponding speed set-value is to be applied via terminal X1/8.

Alternatively to the set-value potentiometer, the current limitation can also be under linear influence from an external control voltage.

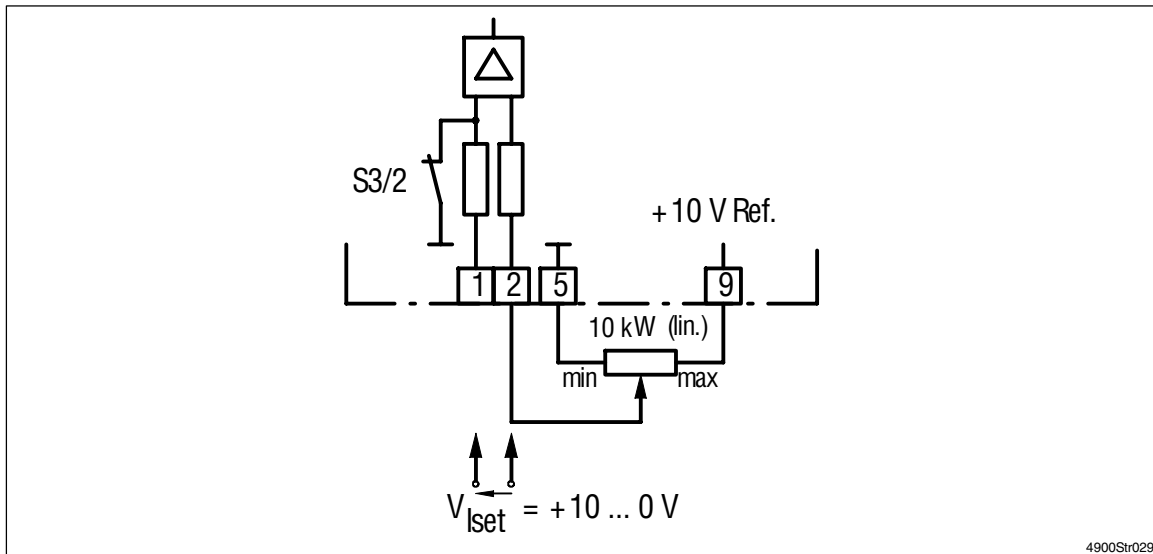
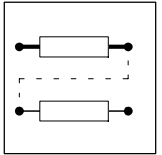

FIG 7-2 Connection diagram for external torque reduction via potentiometer or master voltage



Note!

The terminal input is inverted and assigned with 100 % I_{max} to reduce the wiring for standard applications without external torque limitation.

For torque limit inputs (e. g. via master frequency), the function C047 = 100% - lterminal (1,2) can be changed to function C047 = lterminal (X5).

Code	Name	Possible settings		
		Lenze	Selection	Info
C282*	Function for C047	0	-0- Function C047 = 100% - input source -1- Function C047 = input source	

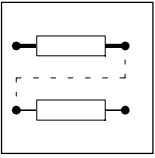

Configuration

7.1.1.6 Acceleration and deceleration times T_{ir} , T_{if}

Each acceleration or deceleration time refers to a speed change from 0 to n_{max} (C011). The times T_{ir} and T_{if} to be set can be calculated as follows:

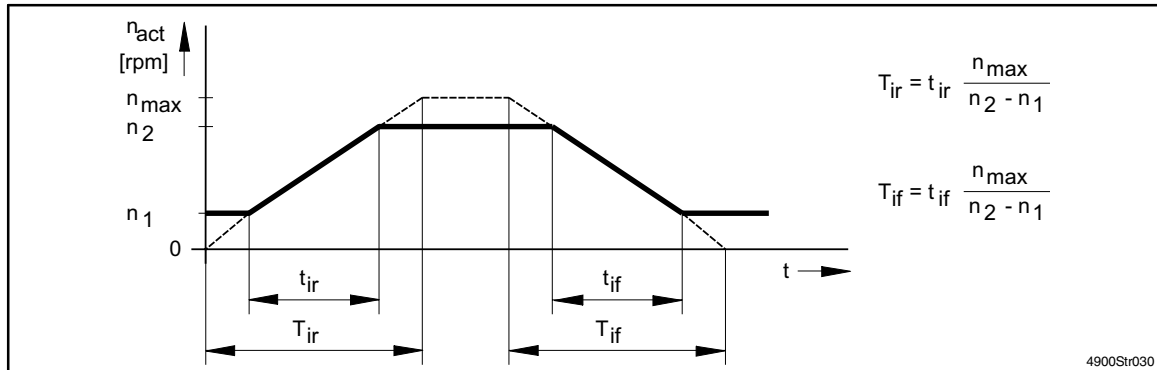

FIG 7-3 Calculation of acceleration and deceleration time

Here t_{ir} and t_{if} correspond to the times desired for the change from n_1 to n_2 and vice versa.

The times T_{ir} and T_{if} calculated are setting values for the controller.

- Acceleration and deceleration time C012 and C013

The ramp function generator of the main set-value (n_{set} or JOG set-value) is set via the times T_{ir} and T_{if} under C012 and C013.

- Additional acceleration and deceleration times

Alternatively to the acceleration and deceleration times under C012 and C013, additional T_{ir} and T_{if} times can be retrieved from the memory, for instance, to change the drive acceleration from a certain speed on.

Programming of additional acceleration and deceleration times

Set the additional T_i times in two steps. The selection under C100 is valid for a pair of acceleration and deceleration times:

- Select additional acceleration/deceleration times under C100.
- Enter the required acceleration time under C101, and the deceleration time under C103.

For several additional T_i times repeat these two steps as often as required.

A maximum of 15 additional acceleration and deceleration times can be programmed.

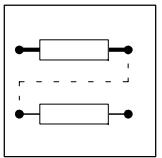

Code	Name	Possible settings			Info
		Lenze	Selection		
C100*	Input: Additional acceleration/deceleration times for main set-value		-1- -2- ... -15-	Acceleration time T_{ir1} /deceleration time T_{if1} Acceleration time T_{ir2} /deceleration time T_{if2} ... Acceleration time T_{ir15} /deceleration time T_{if15}	Extends T_{ir} (C012) and T_{if} (C013) by max. 15 value pairs. Can be changed under C130: 1. Select additional times under C100. 2. Set C101 (T_{ir}) or C103 (T_{if}).
C101*	Acceleration time for C100	0.00s	0 s 1 s 10 s 100 s	{0.01 s} 1 s {0.1s} 10s {1 s} 100 s {10 s} 990 s	Time refers to speed change $0...n_{max}$
C103*	Deceleration time for C100	0.00s	0 s 1 s 10 s 100 s	{0.01 s} 1 s {0.1s} 10s {1 s} 100 s {10 s} 990 s	Time refers to speed change $0...n_{max}$

Assignment of the digital inputs

The of inputs to be assigned with the function "enable additional acceleration and deceleration times", depends on the number of additional T_{i} times.

Number of additional acceleration and deceleration times required	Number of inputs required
1	at least 1
2...3	at least 2
4...7	at least 3
8...15	4

This function can be assigned to up to four inputs.
For input assignment, observe the notes in chapter 5.6

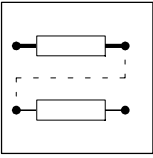

Configuration

Enable of additional acceleration and deceleration times

With terminal control, the inputs must be assigned according to the table below to enable the additional acceleration and deceleration times. T_i times can only be activated in pairs.

	input	2. input	3. input	4. input
T_{ir1}, T_{if1}	1	0	0	0
T_{ir2}, T_{if2}	0	1	0	0
T_{ir3}, T_{if3}	1	1	0	0
T_{ir4}, T_{if4}	0	0	1	0
T_{ir5}, T_{if5}	1	0	1	0
T_{ir6}, T_{if6}	0	1	1	0
T_{ir7}, T_{if7}	1	1	1	0
T_{ir8}, T_{if8}	0	0	0	1
T_{ir9}, T_{if9}	1	0	0	1
T_{ir10}, T_{if10}	0	1	0	1
T_{ir11}, T_{if11}	1	1	0	1
T_{ir12}, T_{if12}	0	0	1	1
T_{ir13}, T_{if13}	1	0	1	1
T_{ir14}, T_{if14}	0	1	1	1
T_{ir15}, T_{if15}	1	1	1	1

The input with the lowest figure is the first input, the input with the next higher figure is the second input, and so on (e. g. E4 = 1. input, E5 = 2. input).

C130 displays the momentarily active T_i times.

With control via keypad or LECOM interfaces, C130 is used for the activation of the T_i times in pairs.

Code	Name	Possible settings		
		Lenze	Selection	Info
C130*	Enable of additional T_i times	0	-0- T_{ir} (C012) / T_{if} (C013) active -1- T_{ir1} / T_{if1} active ... -15- T_{ir15} / T_{if15} active	If the T_i times are enabled via terminal, C130 is for display only.

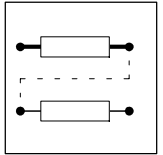

7.1.1.7 Limitation of the speed set-value

Main and additional set-values are lined via the arithmetic block 1 and then limited via a limitation element with adjustable limits (C286, C287). This function can be used if certain negative or positive values must not be exceeded during operation.

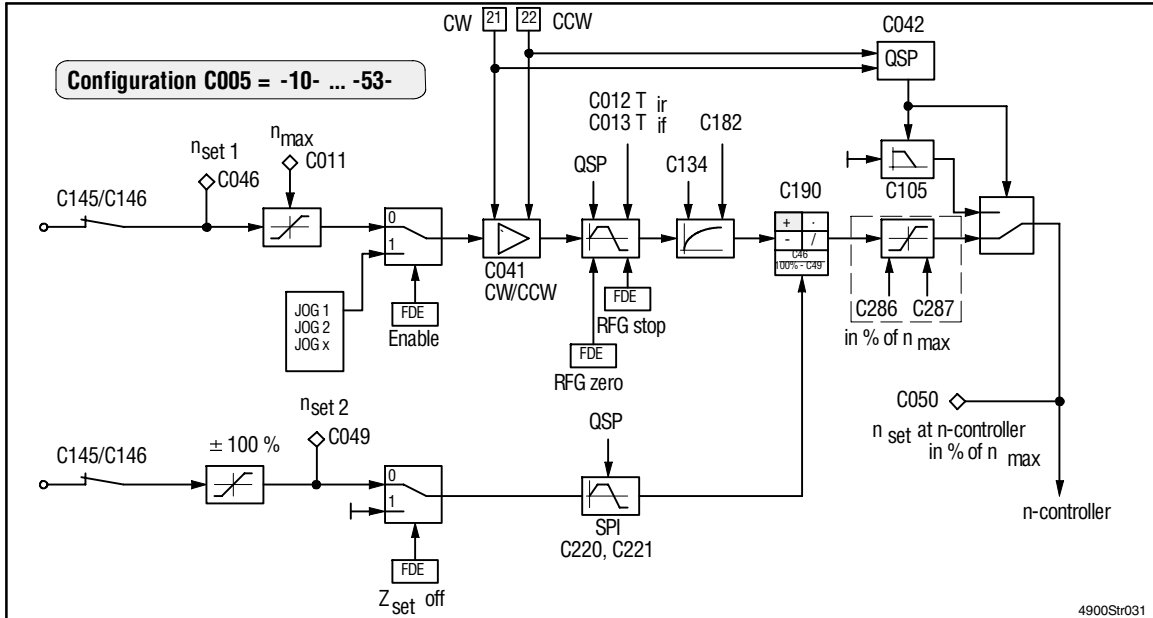
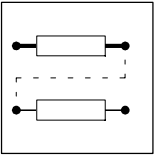

FIG 7-4 Signal-flow chart for speed set-value selection with limitation element

Code	Name	Possible settings				Info
		Lenze	Selection			
C286*	Upper limit of the speed setpoint	180%	-100.0 % -180 %	{0.1 %} {1 %}	+100.0 % +180 %	Upper limit of the speed setpoint for C050 C286 must be higher than C287!
C287*	Lower limit of the speed set-value	-180%	-100.0 % -180 %	{0.1 %} {1 %}	+100.0 % +180 %	Upper limit of the speed setpoint for C050 C287 must be smaller than C286!



Configuration

7.1.2 Actual value feedback

7.1.2.1 Armature voltage feedback

In speed control with armature voltage feedback, the actual speed signal is generated by an internal armature voltage detection. Select C005 = -10- or -40-. The value under C232 (adjustable 0 ... 30% of C090) compensated for the speed error generated by the I · R component of the armature voltage.

Select the "I R-compensation" such that the smallest speed occurs between motor loading and unloading.



Stop!

- Field-weakening operation is not possible with this configuration.
 - The monitoring "Armature circuit interrupted" (ACI) must be solved externally for this configuration, because an interruption cannot be reliably detected.
-

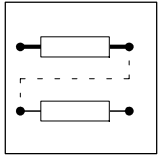

7.1.2.2 DC voltage tacho feedback

The actual speed value is fed back via X1/3 and X1/4. The tacho signal is conditioned with a differential amplifier.



Stop!

Observe for tacho voltage adjustment, that also in field-weakening operation the max. limit for the tacho input of 180 V must not be exceeded.

Possible configurations under C005:

- 11- Speed control with tacho feedback
(Default setting)
- 41- Torque control with speed limitation

For speed control with tacho feedback the analog actual value encoder must be adjusted.

Adjustment of the tacho signal:

The analog inputs can be adjusted in respect of an offset or a gain fault. It is thus possible to correct faults occurring in the controller or during transmission. The value is adjusted to n_{max} (C011).

n_{set} adjustment (main set-value)

1. Inhibit controller via terminal X2/28.
2. Select max. set-value via X1/8.
3. Set C025 ("encoder selection") to -4-.
4. Assign 100 % to the max. set-value under C029 ("automatic adjustment") (with ▲ or ▼).
(Adjustment of level tolerances in the set-value channel).
5. Acknowledge the adjustment with SH + PRG.
6. Set the speed set-value to approx. 50%.

n_{act} adjustment



Stop!

The addition of the mains set-value and the additional set-value is limited to 180% of n_{max} ! I.e. an addition of the additional set-value results in a motor speed of 1.8

n_{max} ·
Observe max. motor speed and rated motor voltage!

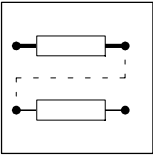

Configuration



Note!

If the field terminals (I, K) or the polarity of the actual value encoder is reversed (resolver, tacho), a TRIP message is sent (see chapter 8.1). After checking and correcting the wiring, the drive can be commissioned again. If the speed becomes stable and the drive is operating with tacho feedback, the speed required can be adjusted.

1. Adapt the rated tacho voltage on board 4902MP by using the DIP switch (see chapter 4.3.4).
2. Set C025 ("encoder selection") to -2-.
3. Select C029 ("automatic adjustment").
4. Enable controller (X2/28).
5. Machine accelerates to speed xxx.
6. Measure speed with hand tacho.
7. Enter measured speed under C029 using the keypad.
8. Accept with SH+PRG.
9. The entered value will be accepted and the machine accelerated to the correct speed with the time T_i of the ramp function generator.

Adjustment of additional set-value

Z_{set} is an additional speed set-value to link a correction signal with the main set-value in the arithmetic block (e.g. dancer position control, correction signal of a synchronised system, correction signal via terminal during the assignment of the main set-value via a serial interface, etc.). Adjustment is carried out when selecting C025 = -3- and subsequent evaluation under C027 or C029.

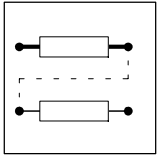

7.1.2.3 Resolver feedback

With the following configurations of C005, a resolver can be used as speed or phase feedback system. It is connected to X7. Resolver adjustment is not required since the resolution is determined by the evaluation system. Possible configuration of C005 are:

- 12- Speed control
- 42- Torque control with speed limitation
- 52- Master with phase control
- 62- Digital frequency bar (set-value bar) with phase control
- 72- Digital frequency cascade with phase control

7.1.2.4 Incremental encoder feedback

With the following configurations of C005, an incremental encoder can be used as speed or phase feedback system. It is connected to X5 or X9. An encoder constant for pulse numbers to the power of two can be directly adjusted under C025 / C026. Encoder bar number, which cannot be represented as a power of two, can be adapted using the evaluation factors C027 and C028. Possible configuration of C005 are:

- 13- Speed control with actual-value feedback via X9
- 43- Torque control with speed limitation
(Act. value feedback via X9)
- 53- Master with phase control (act. value feedback via X5)
- 63- Dig. frequency bar (set-value bar) with phase control
(Act. value feedback via X5)

Resolutions:	1. encoder	8192 incr./rev.	= 0.45 rpm
	2. encoder	4096 incr./rev.	= 0.91 rpm
	3. encoder	2048 incr./rev.	= 1.82 rpm
	4. encoder	1024 incr./rev.	= 3.64 rpm
	5. encoder	512 incr./rev.	= 7.28 rpm
	6. encoder	256 incr./rev.	= 14.56 rpm

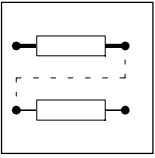

Configuration

7.1.3 Adaptation and adjustment fo the control circuit parameters

7.1.3.1 Adaptation of the armature time constant

If the armature time constant set under C084 (T_{SR}) is not the same as the effective time constant of the motor ($T_{armature}$) (see chapter 5.2), the following occurs:

C084	Effect	Remedy
$T_{SR} > T_{armature}$	Overcurrents in the armature possible, the semi-conductor fuses may trip.	Reduction of C084: <ul style="list-style-type: none"> ● Jump signal to the current controller (e.g. enable the controller when a set-value is applied and the field current is C083 = 0A (motor not running)) ● Observe the signal flow at the monitor output term. 61 by means of an oscilloscope. ● Reduce C084 so that the current can be controlled as fast as possible without overshooting.
$T_{SR} < T_{armature}$	Armature current controls too slowly. Drive provides only little dynamic response.	Increase of C084 under the same criteria as described above.

7.1.3.2 n_{max} setting

C011 maximum speed

The set-value setting range is determined through n_{max} . Enter n_{max} in rpm under C011. n_{max} can be between 250 rpm...5000 rpm. Default setting is 3000 rpm. n_{max} is the reference value for the setting of the deceleration and acceleration times T_{ir} and T_{if} .



Stop!

If the additional set-value is added to the main set-value, the speed set-value C050 can reach up to 180% of n_{max} .

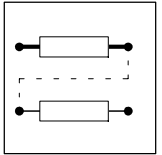

7.1.3.3 Field controller adjustment



Stop!

With field weakening operation, the motor speed can be so high that the motor will be damaged. Do not exceed the maximum speed of the motor (see manufacturer's information).

48XX/49XX controllers include two control concepts for override field control.

- The "V_{ab} limitation" provides a very easy adjustment facility and is sufficient for most applications.
- The control concept "with separate V_{ab} controller" offers a higher dynamic response and accuracy. The adjustment of this system is however more complicated.

The control method is selected under code C230.

Code	Name	Possible settings		
		Lenze	Selection	Info
[C230*]	Control mode for the override field control	0	-0- Limitation of the armature voltage -1- Control of the armature voltage	Field weakening must be permitted under C231.



Note!

If field weakening operation is not required, enter the rated field current (C083). To avoid impermissibly high armature voltage at active loads, the field current is reduced to its minimum value (C231) by inhibiting the controller until $n_{act} = 0$ is reached.

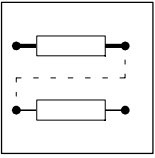

Configuration

Rating to detect I_{Fmin}

With the parameter I_{Fmin} (C231), the speed setting range is limited so that operation at impermissible speed is avoided.

The following diagram is based on the standard excitation characteristic. The value really required for I_{Fmin} (C231) is however dependent on the excitation characteristic of the machine used. The following indications can therefore only serve the orientation.

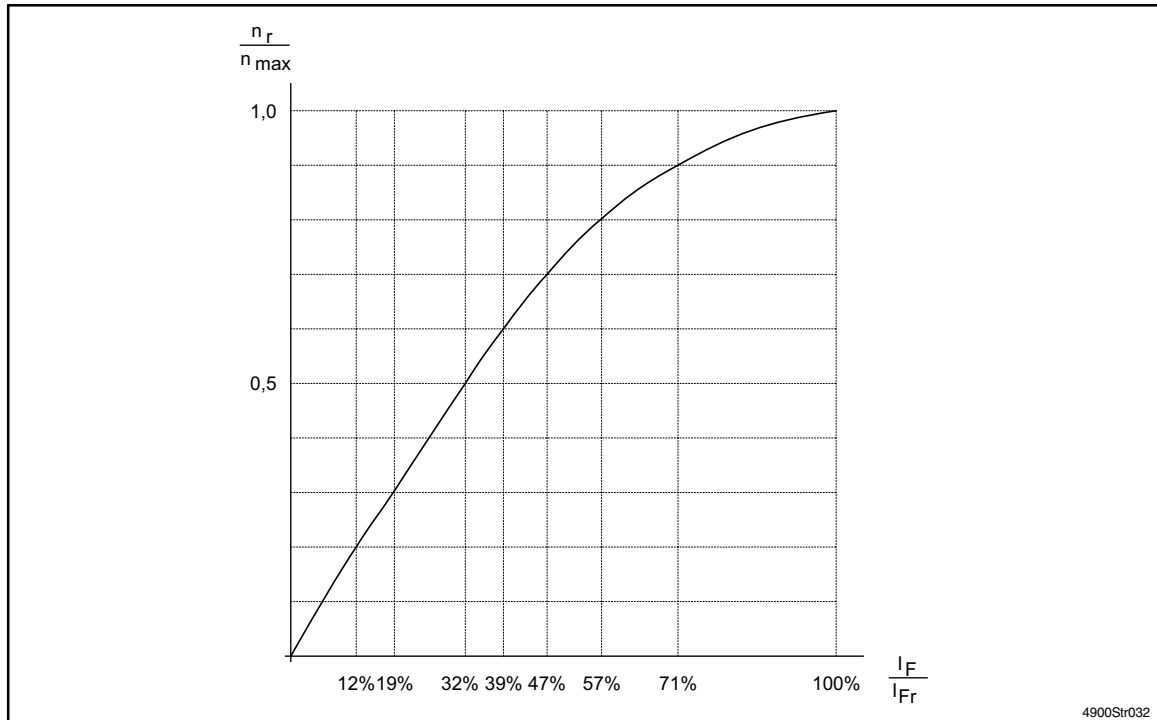

FIG 7-5 Detection of the min. field current in relation to the speed ratio

Example: $n_{rated} = 1500 \text{ rpm}$, $n_{max} = 3000 \text{ rpm}$, i.e. $n_{rated} / n_{max} = 0.5$
The value to be set under C231 is to be calculated.

Result: For this speed ratio, the diagram indicates approx. 32% for C231.

If necessary, adapt the gain and the integral action time of the field controller under C077, C078 to different field time constants of the motors. Set C077 and C078 that the field current does not oscillate in field weakening operation.

- V_{ab} limitation

The integrated field controller enables the speed adjustment by field current weakening. The field current operation is automatically derived from the control level of the armature current controller. With the armature voltage limitation, the max. motor voltage is limited to static $V_{Amax} = 1.05 \cdot V_{Arated}$ (C090) (short-term overswinging of the armature voltage possible).

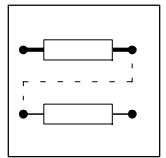

Adjustment of the field weakening operation:

1. Enter I_{Fmin} under C231 (10...100% ref. to I_{Frated}).
2. Selection of 100% n_{set} at X1/8.
3. Increase n_{max} under C011 until reaching the required speed.

There is a PT1 element with an adjustable time constant between armature current controller and field current controller. With this PT1 element the two circuits can be decoupled.

The time constant is set to 140 ms as standard. For standard applications the time must not be adjusted.

If the field control circuit is unstable in field weakening operation, increase or decrease the time constant of the PT1 element.

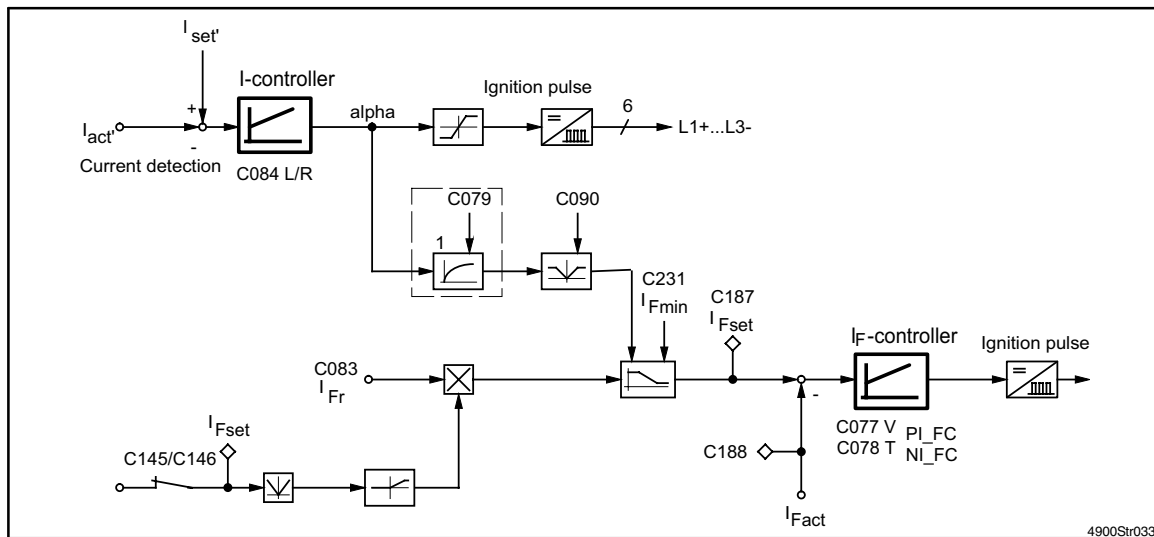
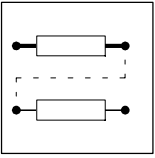

FIG 7-6 Signal flow chart (section) for the field control circuit with Vdown limitation

Code	Name	Possible settings				Info
		Lenze	Selection			
C079*	PT1 element Time constant for field controller attenuation	140 ms	30 ms	{10 ms}	9000 ms	The higher the time constant, the higher the decoupling degree between aramture and field control circuits.

In general, the time constant is to be increased if the field current oscillates. As a result, the dynamic response of the system is reduced.



Configuration

- V_{ab} control

The field weakening operation is derived from the control level of the V_{down} controller. With this control, the maximum motor voltage is limited to static $V_{Amax} = 1.05 V_{Arated}$ (C090). The dynamic response is adjusted via the parameters for the V_{ab} controller and the field controller.

Adjustment of the field weakening operation:

1. Enter I_{Fmin} under C231 (10...100% ref. to I_{Frated}).
2. Selection of 100% n_{set} at X1/8.
3. Increase n_{max} under C011 until reaching the required speed.
4. Adjustment of the proportional gain of the V_{ab} controller (C233)
5. Adjustment of the integral action time of the V_{ab} controller (C234)

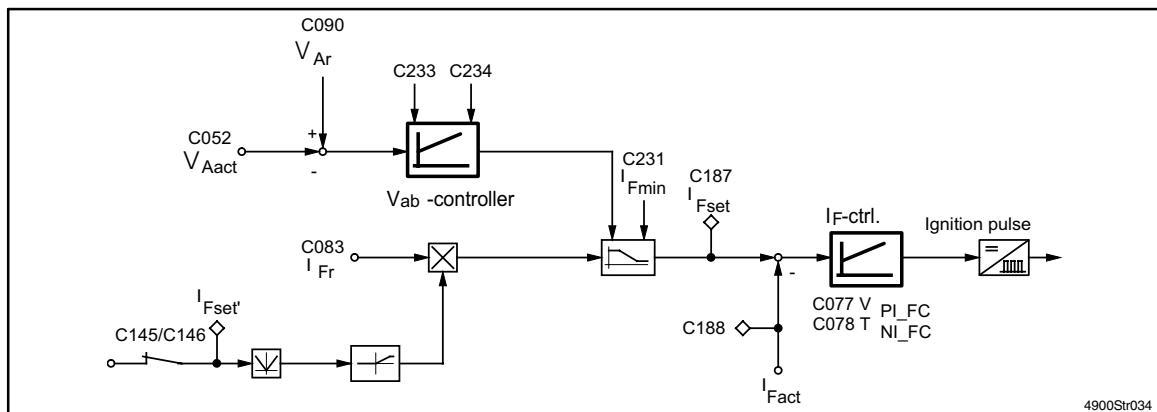

FIG 7-7 Signal-flow chart (section) for the field control circuit with V_{ab} control

7.1.3.4 Adjustment of speed controller parameters

C070 V_{pn} speed controller

Adapt the drive to different inertias under C070:

1. Increase C070 until the drive becomes instable.
2. Reduce C070 by approx 5 % until the drive becomes stable again.

C071 T_{nn} speed controller

The integral action time of the speed controller is set to the lower level current controller. It is not necessary to optimise it for easy speed controls.



Note!

With $T_{nn} = 9999ms$, the speed controller operates as proportional controller. For operation with higher-level control circuits with integral action component, the speed controller should be parameterised as P controller.

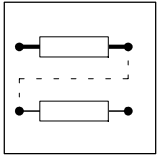

C072 K_{dn} speed controller

For an improved starting behaviour of high-level controls, it is possible to set a differential component in the speed controller. The factor indicated refers to the proportional gain set under C070.

7.1.4 Offset and gain adjustment

- With these functions, the connected analog encoders can be adapted.
- In default setting, the offset voltages of the analog channels are adjusted.
- The offset voltages are not overwritten when loading the default setting.
- Carry out the offset adjustment before adjusting the gain.

Offset adjustment

1. Apply signal 0 V to the input to be adjusted.
2. Select the corresponding analog input under C025.
3. Set the offset correction under C026 (internal display = 0).

Input	Display code	Meaning (default setting)
X1/1, 2	C047	Torque limitation
X1/3, 4	C051	Actual value at C005 = -11-, -41-
X1/6	C049	Additional setpoint
X1/8	C046	n_{set}

Gain adjustment

1. Apply the set-value, to which the internal display is to be adjusted, to the input to be adjusted.
2. Select the corresponding analog input under C025.
3. Select the signal gain under C027 or C029 such that the internal display matches the set-value selection.



Note!

For adjustment of the actual-value input see chapter 7.1.2

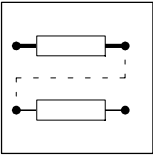

Configuration

Code	Name	Possible settings		
		Lenze	Selection	Info
C025	Input selection: Input adjustment	2	-1- Terminals X1/1, X1/2 -2- Terminals X1/3, X1/4 -3- Terminal X1/6 -4- Terminal X1/8 -5- Armature voltage feedback -10- Digital frequency input X5 -11- Digital frequency input X9 -12- Resolver X7 -13- Encoder output X8	Select the input which is to be adjusted with C026, C027, C028 or C029 under C025.
C026	Encoder constant for C025	0mV	C007 = -5-, -6-, -9-, -20-: Offset correction of the analog inputs -9999 mV {1 mV} +9999 mV	The encoder constants are not overwritten when loading the factory setting.
		0V	C025 = -5-: Offset correction of the armature voltage feedback -100V {1V} +100V	
		1	C025 = -10-, -11-: Encoder constant of the digital frequency inputs -0- 8192 increments / revolution -1- 4096 increments / revolution -2- 2048 increments / revolution -3- 1024 increments / revolution -4- 512 increments / revolution -5- 256 increments / revolution	
		3	C025 = -13-: Encoder constant of the encoder output with resolver feedback -1- 256 increments / revolution -2- 512 increments / revolution -3- 1024 increments / revolution -4- 2048 increments / revolution	
C027	Gain factor for C025	1.000	C007 = -5-, -6-, -9-, -20-: Gain factor of the analog inputs -2.500 {0.001} +2.500	
		1.000	With C005 = -11-, -41-: Gain factor of the tachometer input X1/3, X1/4 0.010 {0.001} +9.999	
		1.010	C025 = -5-: Gain factor for the armature voltage feedback 0.100 {0.001} +9.999	
		0.1000	C025 = -10-, -11-: Gain factor of the digital frequency input -3.2767 {0.0001}+3.2767	If an analog signal source (C145/C146) is assigned, the parameter will be displayed only.
		1.000	C025 = -12-: Gain factor of the resolvers -32.767 {0.001} +32.767	
C028	Divisor for C025	0.1000	C025 = -10-, -11-: Divisor for the digital frequency inputs 0.0001 {0.0001} 3.2767	

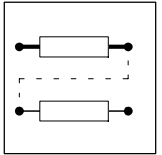

Code	Name	Possible settings		
		Lenze	Selection	Info
C029	Automatic adjustment for C025	100%		This applies to all configurations: If an automatic adjustment is not possible, the previous value will be maintained. --ok-- will not be displayed.
			C007 = -5-, -6-, -9-, -20-: Automatic adjustment for analog inputs -100.0 % {0.1 %} 100.0%	<ol style="list-style-type: none"> Inhibit controller. Set setpoint at the terminal selected. Enter the required values. C027 displays the calculated gain factor.
			C025 = -2- and tachometer at X1/3, X1/4 or C025 = -5- and actual value from armature voltage feedback: n_{act} adjustment 0 rpm {1rpm} 5000rpm	<p>Adjustment during operation:</p> <ol style="list-style-type: none"> Display of actual speed. Measure real speed with hand tachometer. Enter real speed. Drive accelerates to this speed. C027 displays the calculated gain factor.
			C025 = -10-, -11-: Adjustment of the digital frequency inputs X5, X9 -100.0 % {0.1 %} 100.0%	<p>Automatic adjustment only possible, if X5 or X9 are not selected as actual speed inputs:</p> <ol style="list-style-type: none"> Display of actual output value. Enter required output value. C027 displays the calculated gain factor.
			C025 = -12-: Adjustment of the resolver -100.0 % {0.1 %} 100.0%	<p>Automatic adjustment is only possible, if the resolver is not used as speed feedback system:</p> <ol style="list-style-type: none"> Display of actual output value. Enter required output value. C027 displays the calculated gain factor.

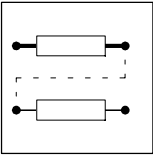

Configuration

7.1.5 Freely assignable inputs and outputs

7.1.5.1 Freely assignable digital inputs (FDI)

Change of the function assignment

Proceed as follows to assign a new function to an input:

- Select the input to be assigned under code C112.
- Select the function required under code C113.
- Select under code C114 whether the function is to be activated with a HIGH or a LOW signal.
- Determine under code C115 whether the function is always to be switched via terminal or, depending on the operating mode, via the correspondingly selected interface.

Code	Name	Possible settings		
		Lenze	Selection	Info
C112*	Input selection: Freely assignable digital input	1	-1- digital input X2/E1 -2- digital input X2/E2 ... -5- digital input X2/E5	The digital inputs E1..E5 are freely assignable with the functions under C113. Each function can only be assigned to one input. Exceptions: C113 = -20- : max. 2 dig. inputs C113 = -1-, -2-, -40-: max. 4 dig. inputs (binary coded selection of max. 1, 3, 7 or 15 additional T _i times or set-values). Assignment of functions: 1. Select input under C112. 2. Assign function under C113. 3. Determine polarity under C114. 4. Determine priority under C115.
[C113*]	Function for C112		-0- No function -1- Enable additional T _i times -2- Enable JOG set-value (X4/E4, E5) -3- TRIP reset (X2/E2) -4- TRIP set (X2/E1) -6- Switch-off additional setpoint (X4/E3) -7- Switch-off I-component of the n-controller -9- Ramp function generator stop -10- Ramp function generator zero -16- Motor potentiometer deactivated -17- Motor potentiometer down -18- Motor potentiometer up -20- Select parameter set -21- Load parameter set -30- Deactivate process controller -31- Switch-off I-component of the process controller -32- Set process controller evaluation to 0 -40- Enable fixed set-value	
[C114*]	Polarity for C112	0	-0- Input HIGH active -1- Input LOW active	

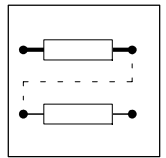

Code	Name	Possible settings		
		Lenze	Selection	Info
[C115*]	Priority for C112		-0- Deactivate terminal function, if terminal control is switched-off under C001. (X2/E4, E5) -1- Terminal function remains active, if terminal control is switched-off under C001. (X2/E1, E2, E3)	
C136*	FDI Status		Bit 0 FDI 1 ... 3 FDI 4 4 FDI 5	Only readable via LECOM. C136 indicates the states of the digital inputs as decimal or binary value. The change of polarity under C114 is considered in C136.

Example for enable of additional T_i time for terminal E2

- C112 -2- Digital input X2/E2
- C113 -1- Enable additional T_i times

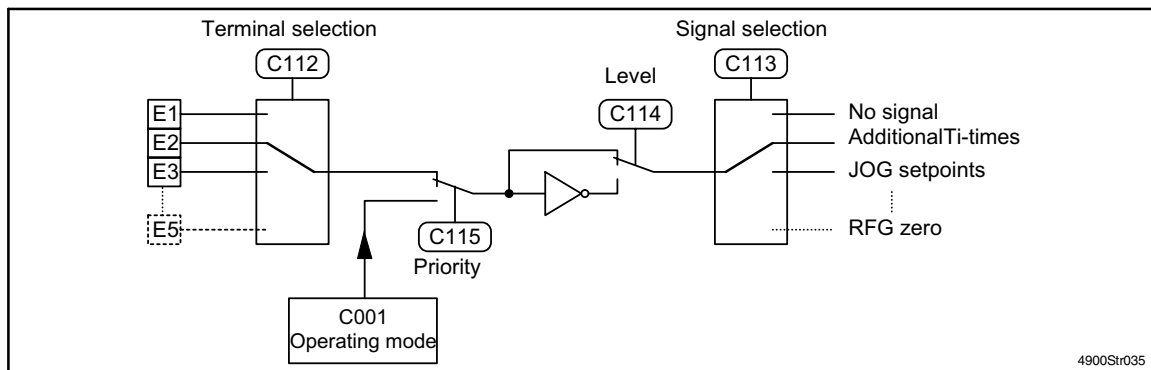

FIG 7-8 Parameter assignment for digital inputs

Except the functions "Enable JOG set-values", "Enable additional acceleration and deceleration times", "Enable fixed set-values" and "Select parameter set", each function can only be assigned to one terminal. An already assigned function will be overwriting by re-assigning the input.

A function, which is already assigned to an input, can only be assigned to another terminal, if the input used before is assigned with a new function.

LECOM code for FDI

The states of FDI (E1 ... E5) can be displayed in binar format in C136 or they can be read out in HEX format via the LECOM interface.

FDI assignment in C136:

Bit 15	Bit 4	Bit 3	Bit 2	Bit 1	Bit 0
not assigned		FDI5	FDI4	FDI3	FDI2	FDI1

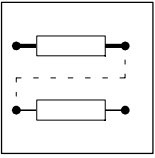

Configuration

7.1.5.2 Freely assignable digital outputs (FDO)

13 freely assignable digital outputs are available. 5 FDOs are in form of terminals and can be alternatively supplied via the internal voltage supply or externally with a 24V PLC signal source. 1 FDO is designed as digital relay output. The other 7 FDOs can be evaluated via the LECOM interface. Each FDO can be assigned with signals according to C117. The FDO status can be indicated via LECOM interface.

The following terminals are assigned to the FDOs:

- Terminals A1...A5 => FDA1...FDA5
- Relay output K11/K14 => FDO relay

Via LECOM interfaces, a FDO signal is always detected as active with a 1-signal. The terminal signals can be inverted under code C118.

The output of the FDOs assigned to the terminals A1...A5 and the relay can be delayed. The delay time can be adjusted in 1 ms steps under C128.

Change of the function assignment

Proceed as follows to assign a new function to an output:

- Select the output to be assigned under C116.
- Select the function under C117.
- Select the terminal level under C118.
- If necessary, determine a signal delay under C128.

Function of the delay time

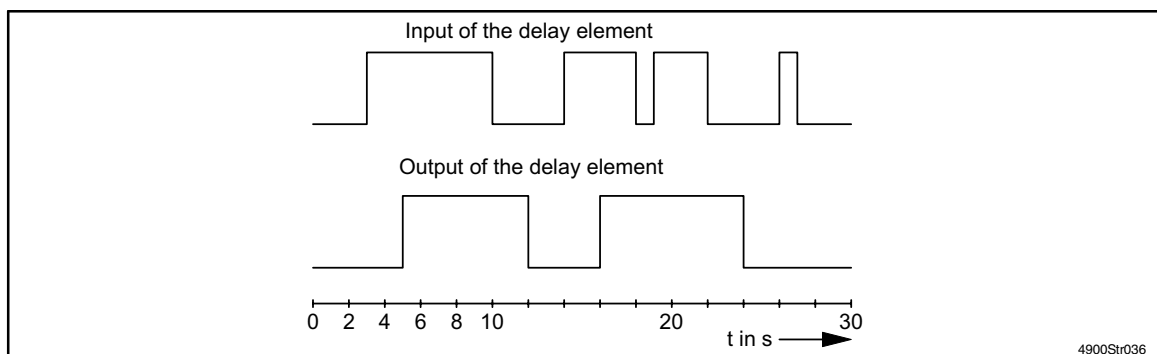
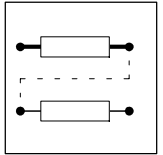

FIG 7-9 Signal flow for a delay time of 2s (C128 = 2s)



LECOM code for FDO

The states of the FDOs can be displayed in binary format in C151 or they can be read out in HEX format via the LECOM interface.

Order of FDOs in C151

Bit 15

Bit 0

0	0	0	Relay	FDO12	FDO11	FDO10	FDO9	FDO8	FDO7	FDO6	FDO5	FDO4	FDO3	FDO2	FDO1
---	---	---	-------	-------	-------	-------	------	------	------	------	------	------	------	------	------

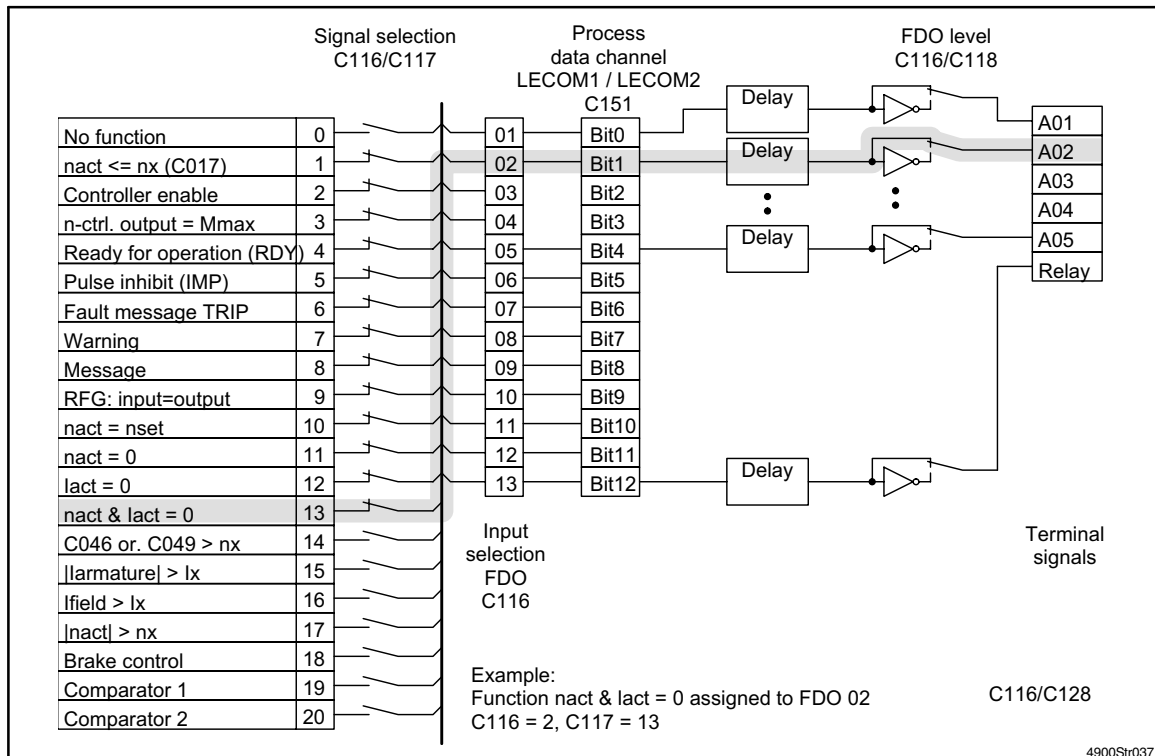
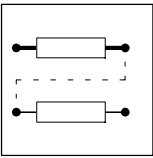
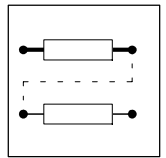

FIG 7-10 Overview of the freely assignable digital outputs (FDO)



Configuration

Code	Name	Possible settings		Info
		Lenze	Selection	
C116*	Input selection: Freely assignable digital output	1	-1- FDO 1 -2- FDO 2 ... -12- FDO 12 -13- Relay output X3/K11, X3/K14	The digital outputs FDO1..FDO12 and the relay output X3/K11, X3/K14 are freelay assignable with the functions under C117. Multiple assignment is possible. The outputs FDO1...FDO5 are assigned to the terminals X3/A1...X3/A5. FDO6...FDO12 can only be accessed via LECOM. Assignment of functions: 1. Select output under C116. 2. Assign function under C117. Only for FDO1...FDO5, relay output: 3. Determine polarity under C118. 4. Determine signal delay under C128.
[C117*]	Function for C116		-0- No function -1- $n_{act} \quad n_x$ C017 (FDO1) -2- Controller enabled (FDO10) -3- n-controller output = M_{max} (FDO2) -4- Ready for operation (RDY) (FDO11) -5- Pulse inhibit (IMP) (FDO12) -6- TRIP (relay) -7- Warning (FDO6) -8- Message (FDO7) -9- Ramp function generator Input = Output (FDO3) -10- $n_{act} = n_{set}$ (FDO5) -11- $n_{act} = 0$ (FDO4) -12- $I_A = 0$ (FDO8) -13- $I_A \& n_{act} = 0$ (FDO9) -14- $ C046 $ or $ C049 > n_x$ (Threshold C243) -15- $ I_A > I_x$ (Threshold C244) -16- $I_F > I_x$ (Threshold C245) -17- $ n_{act} > n_x$ (Threshold C242) -18- Brake control -19- Comparator 1 -20- Comparator 2	
[C118]	Polarity for C116		-0- Output is HIGH active (FDO2, 3, 5) -1- Output is LOW active (FDO1, 4, relay)	
C128*	Delay for C116	0.000 s	0.000 s {0.001 s} 240.000 s	Signal delay times for FDO 1...5 and relay output.



Signal flow	Function
<p style="text-align: right;">4900SStr118</p>	$n_{act} \quad n_x$ Threshold adjustable under C017 from -5000rpm...+5000rpm. Hysteresis fixed 25rpm, default setting: C017 = -3000rpm ● Purpose For monitoring the act. speed with torque control C005 = -40-...-43- ● Output level = LOW
<p style="text-align: right;">4900SStr119</p>	n -controller output = M_{max} Window fixed 99.9% from n -controller output. Hysteresis fixed 1.9%. The signal is equivalent to I_{max} . LED at the operating unit ● Purpose Monitoring of the speed control circuit for limitation (control error) ● Output level = HIGH
<p style="text-align: right;">4900SStr120</p>	$RFG_{Inp} = RFG_{Outp}$ Window adjustable under C241 from 0...100% Hysteresis fixed 1% of n_{max} , default setting: C241 = 1% ● Purpose Signal for detection of acceleration processes in the set-value channel ● Output level = HIGH
<p style="text-align: right;">4900SStr127</p>	$n_{act} = 0$ Threshold adjustable under C019 from 0...5000rpm. Hysteresis fixed 25rpm, default setting: C019 = 50rpm ● Purpose Signal for reliable mains switch-off, standstill detection ● Output level = LOW
<p style="text-align: right;">4900SStr121</p>	$n_{act} = n_{set}$ Window adjustable under C240 from 0...100%. Hysteresis fixed 25rpm, default setting: C240 = 1% ● Purpose Signal for detection of control deviation in the speed control circuit ● Output level = HIGH
<p style="text-align: right;">4900SStr123</p>	$n_{act} \quad n_x$ Threshold adjustable from 100 to +5000rpm under C242. Hysteresis fixed 2% of n_{max} Default setting: C242 = 1000rpm ● Purpose Monitoring of the actual speed for overspeed ● Output level = HIGH
<p style="text-align: right;">4900SStr124</p>	$C046 \text{ or } C049 \quad n_x$ Threshold adjustable from 0 to 100% under C243 Hysteresis fixed, default setting: C243 = 1% ● Purpose Starting protection at digital frequency coupling and analog correction signal ● Output level = HIGH

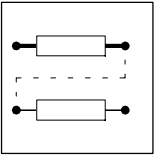

Configuration

Signal flow	Function
	I_A I_x Threshold adjustable from 0 to 100% under C244 Hysteresis fixed, default setting: C244 = 10% • Purpose Adjustable armature current monitoring • Output level = HIGH
	I_F I_x Threshold adjustable from 0 to 100% under C245 Hysteresis fixed Default setting: C245 = 10% • Purpose Adjustable field current monitoring • Output level = HIGH

Info:

The hysteresis indicates range between the threshold or the window at which the function is activated and the switch-off value at which is function is deactivated again.

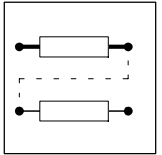

7.1.5.3 Freely assignable “analog” inputs (FAI)

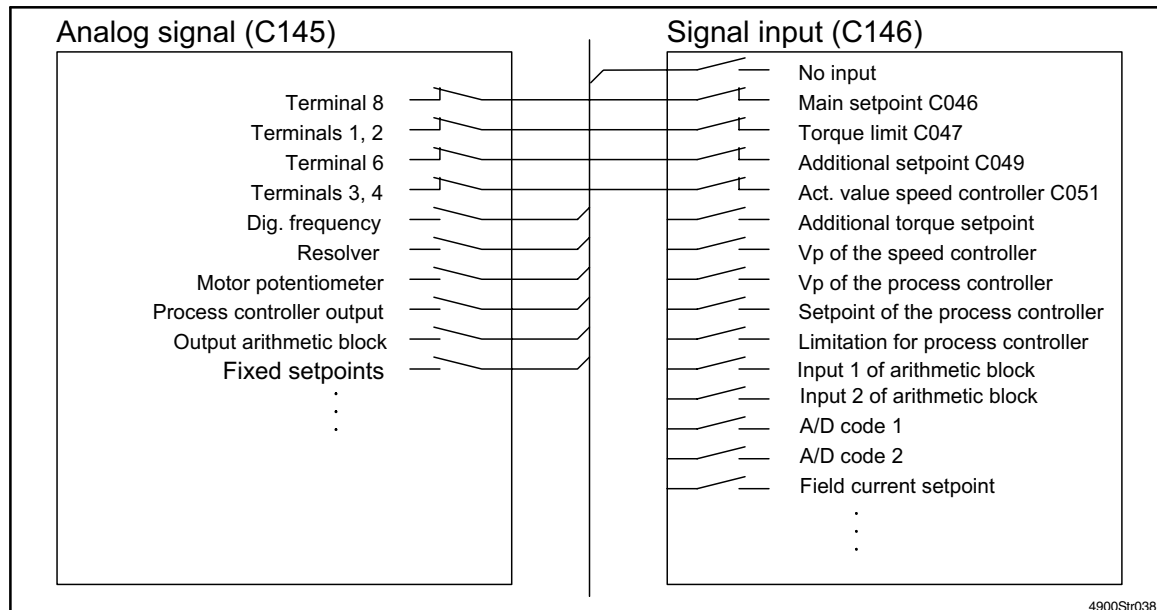

FIG 7-11 FAI assignment with factory setting in configuration C005 = -11-

With each configuration changeover the corresponding analog signals are assigned to the signal inputs according to the configurations. It is also possible to reassign the inputs according to your application.

An analog signal can only be assigned to one function. If an analog signal has already been programmed for the selected signal input, the previous assignment will be overwritten.

A prioritization of the FAI ensures that terminal signals (X1/1 ... X1/8, X5, X7, X9) can be used even if the operating mode C001 is set to interface or keypad control.

If an analog signal is assigned to a code, this input code is for display only. If the assignment of the analog signal to the code is deactivated (e.g. by reassigning the analog signal), the code stays on the value valid at that time.

If the input code is not linked with an analog signal, it can also be assigned to a constant value which can also be stored in EEPROM under C003.

Exception: Parameters cannot be stored in codes C046, C047, C049 and C392.

The assignment of an analog signal to C270 or C271 (A/D-converter) enables a digital evaluation of the analog input signal via interface.

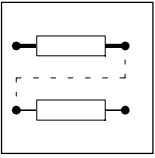

Configuration

Normalization of digital frequency inputs

If the digital frequency inputs X5 and X9 are not assigned to the function setpoint or act. value encoder - depending on the configuration - they can be assigned to a function according to the selection under C146.

The input frequency is normalized via C026, C027 and C028.

Procedure:

1. Depending on the max. input frequency:

Selection C026	corresponds to incr./rev.	f _{input} [kHz]
-5-	256	< 60
-4-	512	< 120
-3-	1024	< 240
-2-	2048	> 240

2. Numerator and denominator of the normalization factor:

- Numerator = $1024 / 2^{(C026)}$
 - For (C026): Enter the section number (see table above)
- Denominator = Input frequency [kHz];
The value entered corresponds to 100% setpoint

3. Detection of C027 and C028:

Divide numerator and denominator of the normalization factor by a adaptation factor for both to get setting values for C027 and C028 in a range that is accepted by the controller.

Example:

Max. input frequency = 9 kHz

1. C026 = -5- (256 incr./rev.)
2. Normalization factor:
 - Numerator = $1024 / 2^5 = 32.0$;
 - Denominator = 9.0
3. Adaptation factor = 10; setting value C027 = 3.2; setting value C028 = 0.9

The adaptation factor should be as low as possible because of the internal resolution.

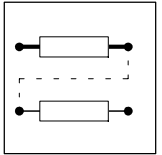

Code	Name	Possible settings		
		Lenze	Selection	Info
C145*	Input selection: Analog signal	1	-1- Input terminals X1/1, X1/2 -2- Input terminals X1/3, X1/4 -3- Input terminal X1/6 -4- Input terminal X1/8 -5- Digital frequency input X5 -6- Digital frequency input X9 -7- Resolver -8- Motor potentiometer output -9- Output process controller -10- Output arithmetic block 2 output 1 -11- Fixed setpoint output -12- Output arithmetic block 2 output 2 -13- Output dead band element output 1 -14- Output dead band element output 2 -15- Output DT1 element output 1 -16- Output DT1 element output 2 -17- Output absolute value generator output 1 -18- Output absolute value generator output 2 -19- Output limiting element 1 output 1 -20- Output limiting element 1 output 2 -21- Output PT1 element output 1 -22- Output PT1 element output 2 -23- Output arithmetic block 3 output 1 -24- Output arithmetic block 3 output 2 -25- Output addition block 1 output 1 -26- Output addition block 1 output 2 -27- Output addition block 2 output 1 -28- Output addition block 2 output 2 -29- n_{act} from C382 -30- n_{set} from C050 -31- Deviation at n-controller (xw) -32- Deviation at process controller (xw) -33- Ramp function generator output -34- n-controller output -35- Square-wave generator -36- Deviation at angle controller -37- RFG output of process controller setpoint -38- RFG output of process controller evaluation -39- AIF process controller setpoint -40- Output limiting element 2 output 1 -41- Output limiting element 2 output 2 -42- Output comparator 1 -43- Output comparator 2	The functions set under C146 can be assigned to the input sources under C145. Double assignment is not possible. The function selected last is always assigned to the input. C007 = -5-, -6-, -9-, -20-: The priority for these inputs can be determined under C147. Change of C005 (configuration): The freely selected assignments are overwritten with a basic assignment that depends on the configuration. Assignments set before must be repeated.

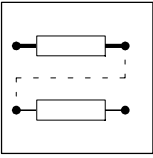

Configuration

Code	Name	Possible settings		Info
		Lenze	Selection	
[C146*]	Function for C145		-0- No function -1- Main setpoint of C046 -2- Input for torque selection -3- Additional setpoint of C049 -4- V_{pn} of the speed controller -5- Field current setpoint -6- Process controller: setpoint (C330) -7- Process controller: actual value -8- Process controller: evaluation (C331) -9- Process controller: ext. V_p setting -10- C027 of X5 -11- C027 of X9 -12- Gearbox factor (C032) -13- Angle trimming of C256 -14- Speed trimming of C257 -15- Arithmetic block 2 - input 1 (C338) -16- Arithmetic block 2 - input 2 (C339) -17- Fixed setpoint block input -18- Analog / digital conversion 1 (C270) -19- Analog / digital conversion 2 (C271) -20- Dead band element input (C622) -21- DT1 element input (C652) -22- Absolute value generator input (C660) -23- Limiting element input (C632) -24- PT1 element input (C641) -25- Arithmetic block 3 - input 1 (C601) -26- Arithmetic block 3 - input 2 (C602) -27- Addition block 1 - input 1 (C610) -28- Addition block 1 - input 2 (C611) -29- Addition block 1 - input 3 (C612) -30- Addition block 2 - input 1 (C614) -31- Addition block 2 - input 2 (C615) -32- Addition block 2 - input 3 (C616) -33- Additional torque setpoint 1 (C148) -34- Additional torque setpoint 2 (C149) -35- FAI input of the S&H module -36- AIF process controller: act. value -37- Limiting element 2 input (C637) -38- Comparator 1 input 1 (C580) -39- Comparator 1 input 2 (C581) -40- Comparator 2 input 1 (C590) -41- Comparator 2 input 2 (C591) -42- Input for ext. excitation characteristic -43- n_{act} of C051 (for tachometer feedback) -44- n_{act} of C051 (for resolver or incremental encoder feedback) -46- Digital frequency setpoint	<p>If C146 = -4-, V_{pn} of the n-controller corresponds to 0% at the input V_{p2} under C320 and 100% at the input V_{pn} under C070.</p> <p>If C146 = -5-, the field current setpoint corresponds to 100% at the input of the rated current under C083. The minimum adjustable value is determined under C231.</p> <p>C146 = -43-, -44-, -46- are for display only (according to the configuration). They cannot be assigned.</p>
[C147*]	Priority for C145		-0- Terminal function not active, if terminal control is switched-off under C001. -1- Terminal function remains active, if terminal control is switched-off under C001.	

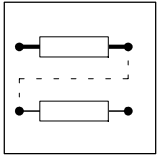

7.1.5.4 Freely assignable monitor outputs

The controller is equipped with two analog (terminals 62 and 63) and a digital (digital frequency output X8) monitor outputs to output internal signals as voltage, current or frequency signals. The positions of switches S1 and S2 required for the analog outputs, can be obtained from chapter 4.3.4.1.

If you want to assign a new signal to an output, select under C110 which output is to be changed. Select under C111 the signal to be assigned to this output. Under C108 and C09 adjust gain and offset (C109 is not valid for the digital frequency output) to adapt the monitor output, for instance, to a display instrument.



Stop!

With freely assignable signals positive feedbacks may occur, which can lead to uncontrolled drive acceleration!

Code	Name	Possible settings		
		Lenze	Selection	Info
C108*	Gain for C110	1.00	-10.000 {0.001} +10.000	Gain for X4/62, X4/63, X8
C109*	Offset for C110	0mV	-10000mV {1mV} +10000mV	Loading of the factory settings does not overwrite C109. Offset for X4/62, X4/63. This code is only effective, if the digital frequency output is selected under C110.
C110*	Input selection: Monitor output	1	-1- Analog output X4/62 (monitor 1) -2- Analog output X4/63 (monitor 2) -3- Digital frequency output X8	The monitor outputs are freely assignable with the signals under C111: 1. Select monitor output under C110. 2. Assign signals under C111. 3. If necessary, adjust under C108 and C109.

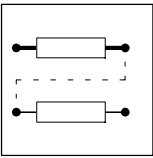

Configuration

Code	Name	Possible settings																																																		
		Lenze	Selection	Info																																																
[C111*]	Signal for C110		-0- No signal -1- Main set-value (C046), reference: n_{max} -2- Input ramp function generator, reference: n_{max} -3- Output ramp function generator, reference: n_{max} -4- Additional set-value (C049), reference: n_{max} -5- n_{set} at the n controller input (C050), reference: n_{max} -6- n_{act} (C051), reference: n_{max} (X4/63) -8- n_{act} (C382), reference: n_{max} (X8) -20- n controller output, reference: M_{max} -21- M_{set} (C047), reference: M_{max} -22- I_{set} (C063), reference: I_{max} (C022, C023), (X4/62) -23- I_{act} (C054), reference: (see 'Info') -25- M_{set} (C056), reference: M_{max} -28- I t load, reference: 100% -29- I ² t load, reference: 100% -30- V_A (C052), reference: 1000 V -35- Mains frequency, reference: 30Hz = 0V, 70Hz = 10V -40- Field current set-value, reference: max. rated field current I_{Fmax} -41- Actual field current, reference: I_{Fmax} -60- Output motor potentiometer, reference: 100% -61- Output process controller, reference: 100% -62- Output arithmetic block 2, reference: 100% -63- Digital frequency input X5, reference: 100% -64- Digital frequency input X9, reference: 100% -65- Resolver, reference: 100% -66- Digital / analog conversion 1 (C272), reference: 100% -67- Digital / analog conversion 2 (C273), reference: 100% -68- Motor power, reference: 5 V = P_{rated} -69- Motor torque, reference: 5 V = M_{rated} -70- Output dead band element, reference: 100% -71- Output DT1 element, reference: 100% -72- Output absolute value generator, reference: 100% -73- Output limitation element 1, reference: 100% -74- Output PT1 element, reference: 100% -75- Output arithmetic block 3, reference: 100% -76- Output addition block 1, reference: 100% -77- Output addition block 2, reference: 100%	In the armature setting range: 100 % M_{max} correspond to 100 % I_{max} (C022, C023) The actual armature current value I_{act} (C054) is normalised according to the controller: <table border="1"> <thead> <tr> <th>I_{act}</th> <th>X4/62, X4/63</th> <th>X8</th> <th>Type</th> </tr> </thead> <tbody> <tr> <td>16A</td> <td>4.4V</td> <td>110kHz</td> <td>4902</td> </tr> <tr> <td>25A</td> <td>4.7V</td> <td>118kHz</td> <td>4903</td> </tr> <tr> <td>55A</td> <td>4.8V</td> <td>120kHz</td> <td>4904</td> </tr> <tr> <td>110A</td> <td>4.9V</td> <td>122kHz</td> <td>4905</td> </tr> <tr> <td>200A</td> <td>6.4V</td> <td>159kHz</td> <td>4906</td> </tr> <tr> <td>250A</td> <td>4.4V</td> <td>110kHz</td> <td>4907</td> </tr> <tr> <td>330A</td> <td>5.2V</td> <td>129kHz</td> <td>4X08</td> </tr> <tr> <td>500A</td> <td>5.8V</td> <td>144kHz</td> <td>4X09</td> </tr> <tr> <td>700A</td> <td>5.8V</td> <td>144kHz</td> <td>4X11</td> </tr> <tr> <td>1000A</td> <td>5.8V</td> <td>146kHz</td> <td>4X12</td> </tr> <tr> <td>1200A</td> <td>7.0V</td> <td>175kHz</td> <td>4X13</td> </tr> </tbody> </table>	I_{act}	X4/62, X4/63	X8	Type	16A	4.4V	110kHz	4902	25A	4.7V	118kHz	4903	55A	4.8V	120kHz	4904	110A	4.9V	122kHz	4905	200A	6.4V	159kHz	4906	250A	4.4V	110kHz	4907	330A	5.2V	129kHz	4X08	500A	5.8V	144kHz	4X09	700A	5.8V	144kHz	4X11	1000A	5.8V	146kHz	4X12	1200A	7.0V	175kHz	4X13
I_{act}	X4/62, X4/63	X8	Type																																																	
16A	4.4V	110kHz	4902																																																	
25A	4.7V	118kHz	4903																																																	
55A	4.8V	120kHz	4904																																																	
110A	4.9V	122kHz	4905																																																	
200A	6.4V	159kHz	4906																																																	
250A	4.4V	110kHz	4907																																																	
330A	5.2V	129kHz	4X08																																																	
500A	5.8V	144kHz	4X09																																																	
700A	5.8V	144kHz	4X11																																																	
1000A	5.8V	146kHz	4X12																																																	
1200A	7.0V	175kHz	4X13																																																	

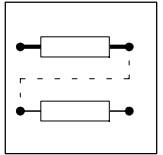

Example for the assignment of a monitor output terminal 62 to the terminal signal C046 "main set-value".

- C110 = -1- Monitor output term. 62
- C111 = -1- Main set-value C046

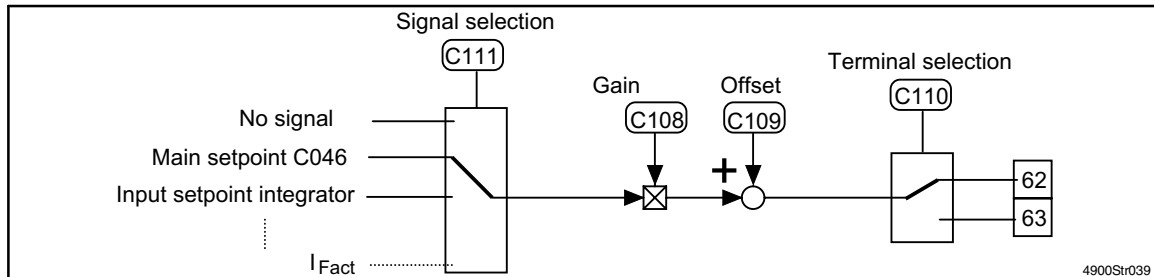
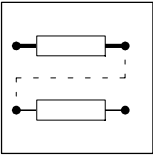

FIG 7-12 Parameter assignment of the monitor outputs

A D/A conversion is possible using the codes C272 and C273, if the code is assigned to an analog output. The digital value written via interface occurs as voltage signal, which has been converted at the programmable monitor output.

Special features of the digital frequency output

If the configuration is changes, the digital frequency output is assigned according to the basic assignment. The signal "n_{act}" is output under C005 =-1X- and -4X-. In all other configuration, the signal "n_{set}" is assigned to the output. The following table informs about the basic assignment of the digital frequency outputs after configuration changeover and the adaptation of the output frequency. If necessary, this assignment can also be changed according to the requirements.



Configuration

Adaptation of the signal at the digital frequency output X8

If another signal than stated in the basic configuration (C005) is assigned, the output frequency is adjusted via code C108.

Configurat ion	Basic assignment	Adaptation of the output frequency with ...			Notes
		C026 if C025 = -13-	C030	C108	
C005		C026 if C025 = -13-	C030	C108	
-10-, -40-	n _{act} from C382	-	-	active	
-11-, -41-	n _{act} from C382	-	-	active	
-12-, -42-	n _{act} from C051	Selection possible	-	-	The rotor zero position, which depends on the resolver, is output on the zero track.
-13-, -43-	n _{act} from C051	-	-	-	The encoder constant is only by the incremental encoder used (hardware). A zero track is only output if it is provided by the incremental encoder.
-5x-	n _{set} from C050	-	Selection possible	-	The output signal is normalized to the number of pulses of the incremental encoder. A zero track will not be output.
-6x-	n _{set} from C050	-	-	-	At the output X8 the signal from X9 is directly output (electrically buffered). A zero track is only output, if it is connected to input X9.
-72-	n _{set} from C050	-	Selection possible	-	The output signal is normalized to the number of pulses of the incremental encoder. The corresponding encoder constant can only be set under C030. The gain can be set via C027 and C028 of the input X5 (C025 = -10-). A zero track will not be output.

The sign ”-” means that a change does not influence the output frequency.

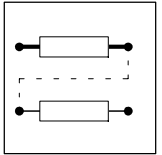

7.2 Torque control with speed limitation

Purpose

The drive is changed to torque control by the setting the configuration to C005 = -4X- "torque control with speed limitation". The torque can be entered in both directions.

In different operating modes, the speed is monitored with a speed limitation by means of the n-controller.

Parameter setting



Stop!

With a negative torque set-value, the speed limitation is not effective. The drive can reach impermissibly an impermissibly high speed, which can damage motor or machine. These applications can only be monitored with the digital output $n_{act} \leq n_x$.

For standard applications, the drive can be immediately commissioned with the default settings. To adapt it to special requirements, please observe the notes in chapter 7.1, "speed-controlled operation".

Set-value	Terminal	Parameter setting with
speed set-value	X1/8	C025 = -4-
Additional set-value	X1/6	C025 = -3-
External torque selection M_{set}	X1/1, 2	C025 = -1-

The speed set-value and the additional set-value are selected as bipolar values via X1/8 or X1/6. The direction of rotation results from the sign of the linkage between main and additional set-value and the selection made at X2/21 und X2/22.

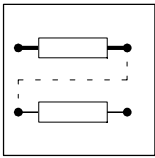

Configuration

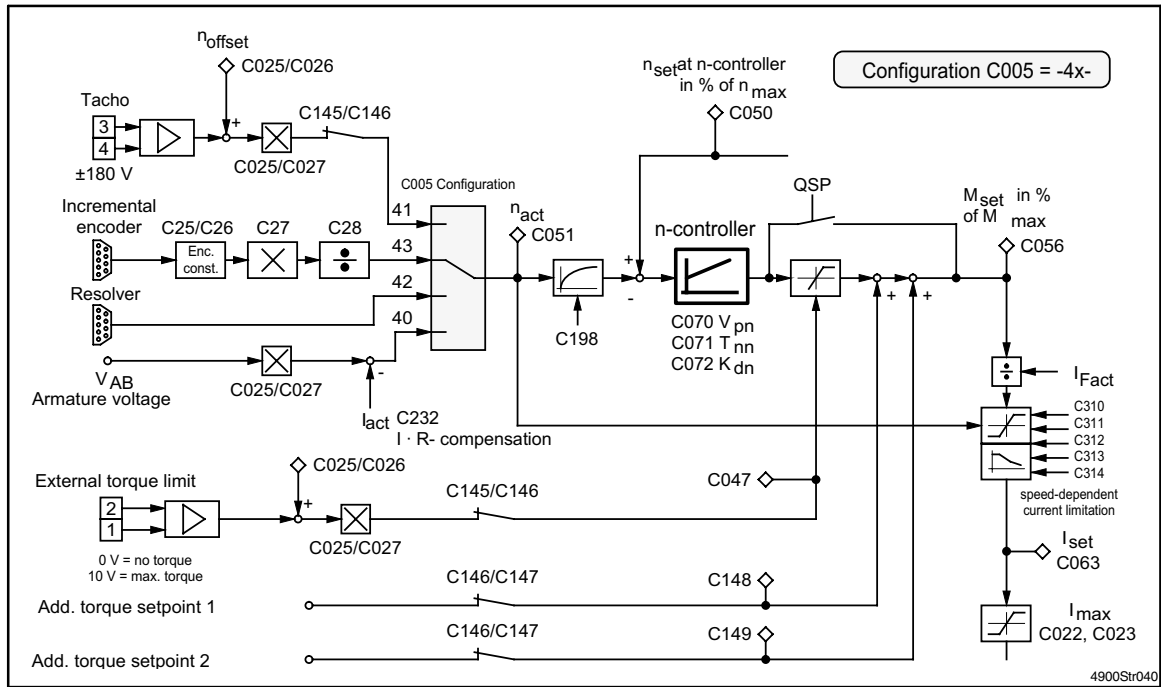
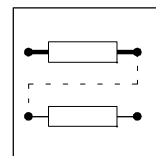

FIG 7-13 Signal-flow chart (section) for torque control with speed limitation (C005 = -4X-)



7.3 Digital frequency coupling

General description of the system

The digital frequency coupling described here enables a digital set-value transmission and evaluation between a set-value source and one or more controllers. The transmission path can be used as bar or cascade for:

- Phase-synchronous running
- Speed-synchronous running
- Speed-ratio synchronism or
- Position controls with drift-free standstill

In every controller, the set-value can be evaluated with a factor and output with a gain at the corresponding digital frequency output.

The digital frequency coupling is a pure digital set-value transmission with all of its advantages:

- drift-free
- extremely precise
- increased noise immunity

Therefore, three configurations are offered:

- Master, C005 = -52-, -53-
- Slave for digital frequency bar, C005 = -62-, -63-
- Slave for digital frequency cascade, C005 = -72-

Set-value conditioning

In the set-value branch, the speed and phase set-values are processed as absolute values.

Gearbox factors (C032 and C033)

The evaluation factors C032 and C033 are in the set-value channel of the corresponding drive (slave). They are used to set the gearbox factor.

Setting range of the factors:

- C032 from -3.2767 to +3.2767
- C033 from +0.0001 to +3.2767.

The quotient is limited to max. 32767.

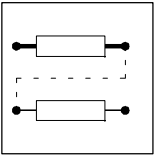

Configuration

7.3.1 Master

Purpose

The master configuration C005 = -52- or -53- is:

- to activate the phase control which is preconnected to the speed controller
- to configure the drive as master drive for the digital frequency coupling to generate the master digital frequency for the following drives

The phase control is used to improve the control features of the drive, so that a drift-free standstill is achieved, e.g. for:

- positioning tasks
- hoists, etc.

The set-value path is selected according to the configurations -1X- and -4X-.

Features

- Either resolver or incremental encoder feedback
- Master with signal conditioning as for the configurations C005 = -1X-, -4X-
- DF output signal is set-value for slave 0 (master drive) and other slaves
- For slave 0 evaluation possibility of the set-value with a factor (numerator/denominator) as well as gearbox adaptation (numerator/denominator). Adjustable via LECOM, motor potentiometer or analog terminal
- External torque limitation possible
- QSP function for the whole drive group
- Ctrl. enable function results in loading of the set-value integrator with the actual value of slave 0 (set-value = actual value)
- Influence possible via codes for phase trimming and speed correction (via LECOM, motor potentiometer, analog terminal or one of the signal sources under C145)
- Indication "following error limit reached" can be set by a code
- TRIP when reaching the phase controller limit
- Speed limit of slave 0 = 1.8 C011
- Phase controller influence of 0 (0 = deactivated) adjustable up to 1.00

The master drive consists of the master integrator and the slave 0. Slave 0 is the first drive at the master frequency.

FIG 7-14 Signal-flow chart for master integrator with slave 0

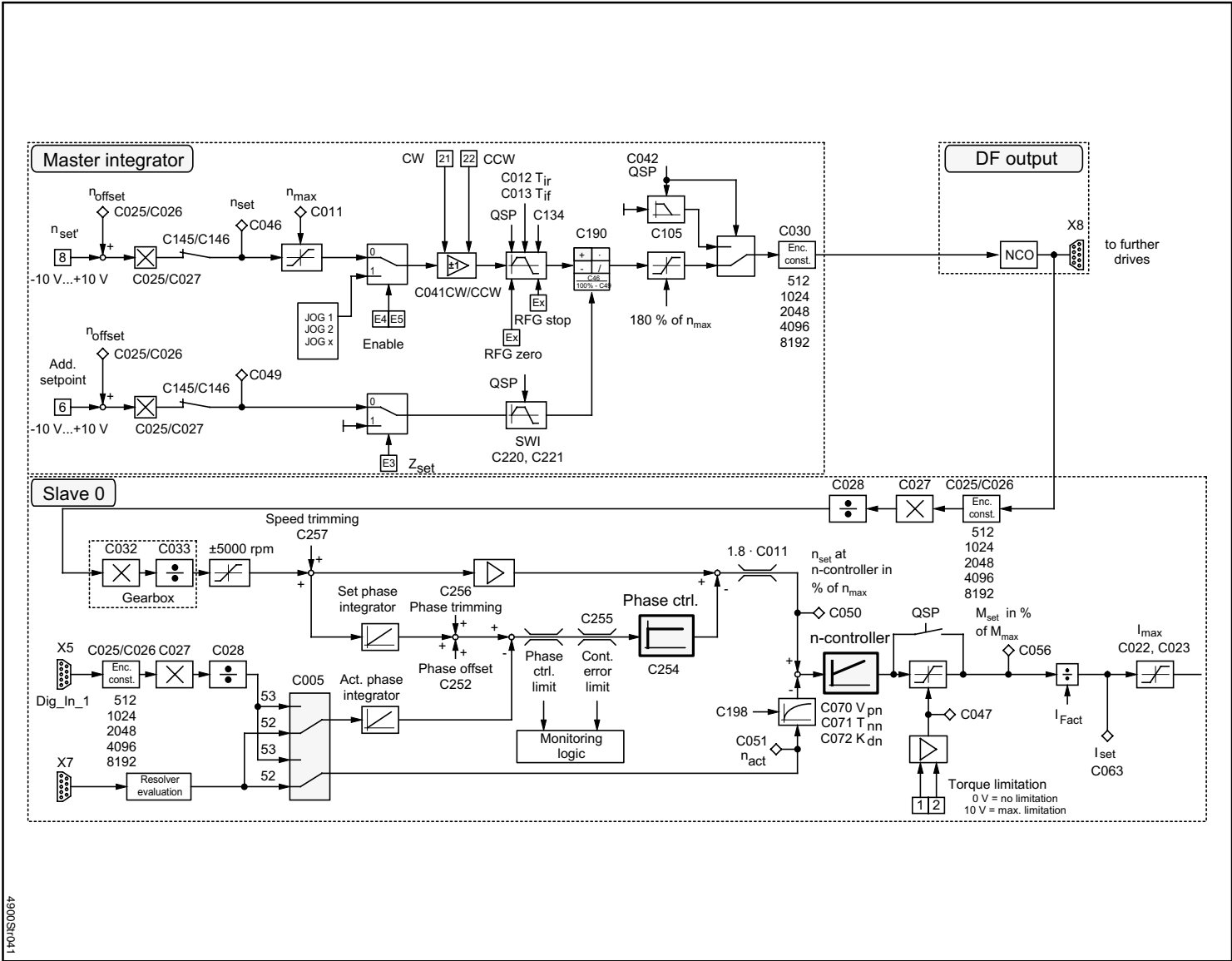

4900SH041

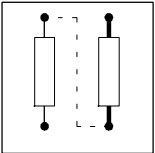

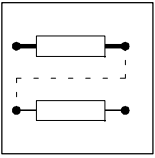

Configuration

QSP at the master

If QSP is switched at the master drive, the set-value (C050) is reduced along the QSP ramp for all drives. Thus, the complete network of drives can be decelerated to standstill by the QSP integrator.

If QSP is reset before standstill is achieved, the network of drives starts to accelerate or decelerate at the set-value integrator with the value set under C050.

QSP at slave 0 (master drive)

If the deceleration ramp is very short and it can only be achieved with I_{max} , the phase synchronism will be lost. With the I_{max} message, the set-value integrator follows the actual phase integrator. Thus, the rotor does not turn back when reaching $n = 0$. If the I_{max} message is reset, the phase control will be reactivated and drift-free standstill can be ensured.

The switching of QSP is a continuous operating mode for the connected slaves so that a reversal is possible, if the deceleration ramp set at the master should be too short for one of the slaves.

Ctrl. enable at the master

If the master is inhibited, the actual value of slave 0 is used as a set-value for the other slaves. Thus, the complete network of drives could be decelerated to standstill by the coasting slave 0.

If the master is enabled before standstill, the network of drives starts to accelerate with the actual speed at the set-value integrator.

The phase difference is set to zero by switching controller enable.

7.3.2 Slave for digital frequency bar

Purpose

With configuration C005 = -62- or -63- for the set-value bar,

- the phase control, which is preconnected to the speed controller, is activated and
- the set-value path is changed to digital frequency coupling for phase and speed synchronous running.

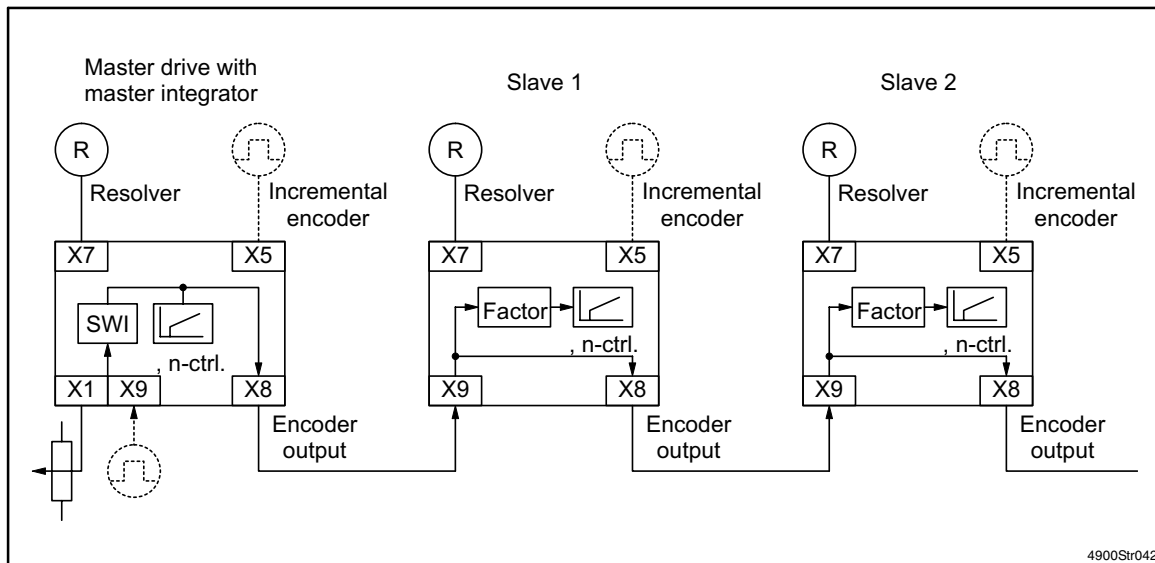
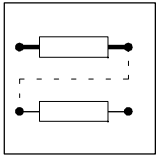
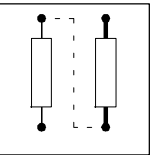

FIG 7-15 Connection diagram for the configuration of the digital frequency bar

M	Master drive with master integrator
S1	Slave 1
S2	Slave 2
R	Resolver

Features

- Either resolver or incremental encoder feedback
- Hardware connection between DF output and DF input
- Another evaluation of the set-value with a factor (numerator/denominator) for the corresponding slave (gearbox adaptation). Adjustable via LECOM, motor potentiometer or analog terminal
- External torque limitation possible
- QSP function for the individual drive. The DF set-value will be output independently of QSP.
- RFR function for the individual drive. The set-value will be output to the DF output independently of the QSP.
- Influence possible via codes for phase trimming and speed correction (via LECOM, motor potentiometer, analog terminal or one of the signal sources under C145)
- Following error limit adjustable via code
- TRIP when reaching the phase controller limit
- Speed limit = 1.8 C011
- Phase controller influence of 0 (0 = deactivated) adjustable up to 1.00
- No alternative set-value conditioning available (JOG, additional set-value, set-value integrator...)



Configuration

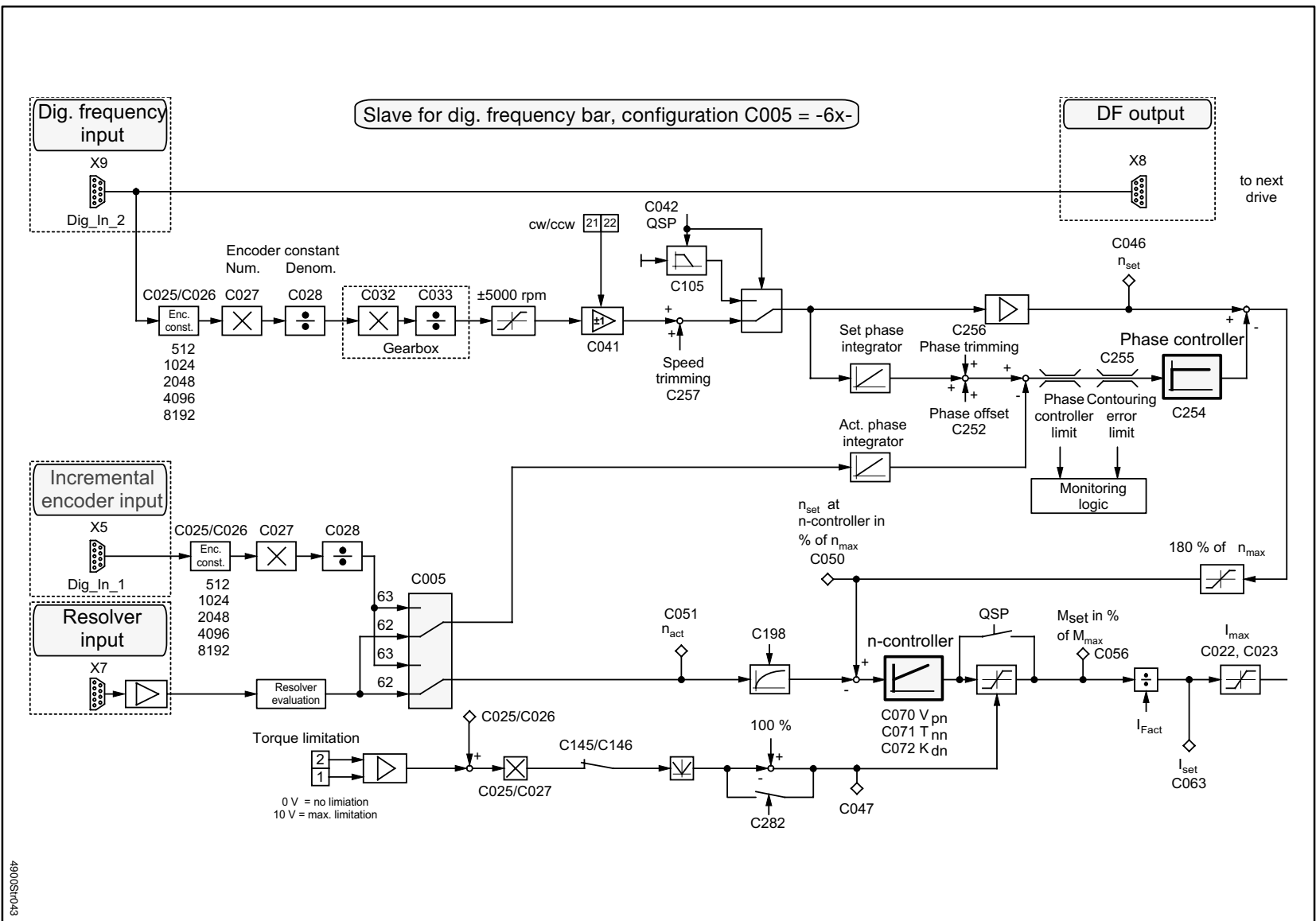
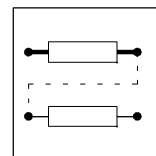

FIG 7-16 Slave for digital frequency bar



Set-value conditioning of the slave

The value read from Dig_In_2 (X9) forms the set-value (speed and phase) for the internal control and is also the output value at the digital frequency output. The set-value is evaluated with the encoder constant (C026, C027 and C028 when C025 = -11-) and the gearbox factors C032 and C033.

The direction of the slave can be changed with the CW/CCW changeover. If the direction of rotation is changed while the machine is running, pulse losses, which lead to phase errors, occur. The direction changeover can, for instance, be used for electrical shafts, consisting of 2 opposite motors.

Special features compared to speed control

- No set-value integrator in the set-value branch.
- The changeover to a JOG value is not possible.
- The additional set-value is not active.

Feedback system

The feedback system is selected by means of the configuration

- C005 = -62- resolver or
- C005 = -63- incremental encoder

QSP at the slave

If QSP is switched at the slave, the set-value (C050) is reduced along the QSP ramp. Homing points are lost. A drift-free standstill is obtained because with the switching of QSP the set phase is led by the QSP integrator.

If the deceleration ramp is very short and it can only be achieved with I_{max} the set-value integrator follows the actual phase integrator. Thus, the rotor does not turn back when reaching $n = 0$. If the I_{max} message is reset, the phase control will be reactivated and drift-free standstill can be ensured.

Ctrl. enable at the slave

If a slave is inhibited, the motor coasts at the friction torque. At the DF output, the set-value for the following slave is still output.

If the slave is enabled, the drive accelerates to its set-value (possibly at the current limit). With switching controller enable, the phase difference is set to zero. Homing points are lost.

Exception

If the controller is inhibited because of a short-term synchronisation fault or mains interruption, the phase difference will not be reset. After mains recovery, the drive is able to follow its set phase. A phase difference, detected before, will be compensated.

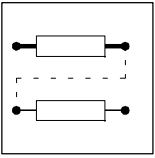

Configuration

7.3.3 Slave for digital frequency cascade

Purpose

With configuration C005 = -72- for the set-value cascade

- the phase control which is connected to the speed controller will be activated
- the set-value path is changed to digital frequency coupling for speed ratio synchronism.

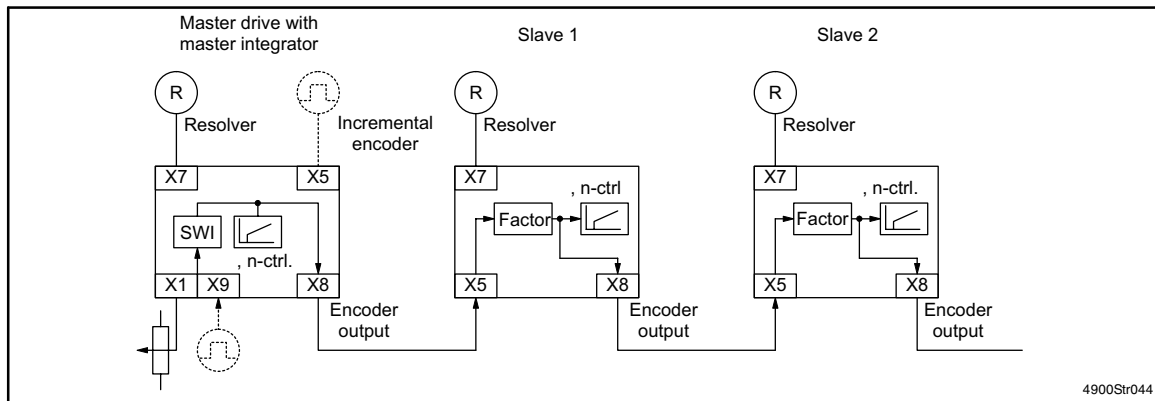
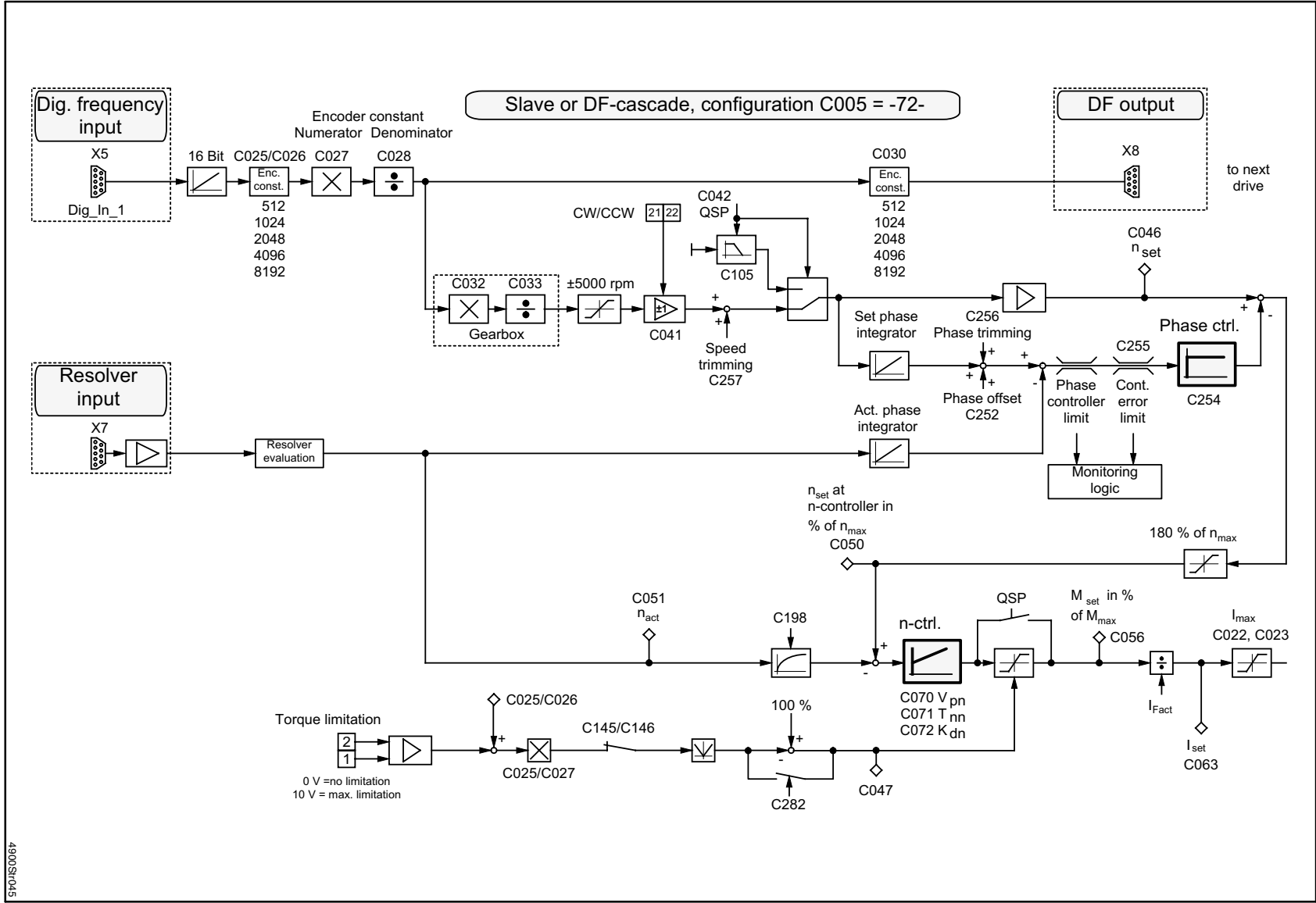

FIG 7-17 Connection diagram for the configuration of the digital frequency cascade

Features

- Only resolver feedback possible
- With a cascading factor evaluation of the set-value (numerator/denominator) possible for the digital frequency output and thus for all following drives adjustable via LECOM, motor potentiometer or analog terminal
- Another evaluation of the set-value with a factor (numerator/denominator) for the corresponding slave (gearbox adaptation). Adjustable via LECOM, motor potentiometer or analog terminal
- External torque limitation possible
- The QSP or RFR function in the individual drive do not influence the set-value of the cascade
- Influence possible via codes for phase trimming and speed correction (via LECOM, motor potentiometer, analog terminal or signal source (C145))
- Following error limit adjustable via code
- TRIP when reaching the phase controller limit
- Speed limit = 1.8 C011
- Phase controller influence of 0 (0 = deactivated) adjustable up to 1.00
- No alternative set-value conditioning available (JOG, additional set-value, set-value integrator, ...)

FIG 7-18 Slave for digital frequency cascade



4900SI1045

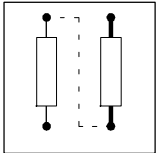

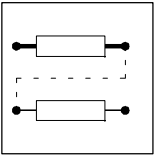

Configuration

Cascading factor

The cascading factor directly influences the set-value at the input Dig_In_1 (X5). Encoder adaptation (C025 = -1-) under C026, C027 and C028.

The following constants can be adjusted under C026:

- 8192 incr./rev.
- 4096 incr./rev.
- 2048 incr./rev.
- 1024 incr./rev.
- 512 incr./rev.

Cascading constants, which cannot be represented as a power of two, can be assigned under C027 / C028. The following relation applies:

$$\frac{C\ 026}{\text{Encoder constant}} = \frac{C\ 027}{C\ 028}$$

Setting range of the factors:

- C027 from -3.2767 to +3.2767
- C028 from +0.0001 to +3.2767.

The quotient is limited to max. 32767.



Note!

For the largest possible internal resolution, set C026 = -0- (8192 incr./rev.) and under C027 the value +0.8192 (8192 incr./rev. divided by 10,000) should be set. Indicate the effective encoder constant, which is evaluated with the divisor 10,000, under C028.

Example:

Encoder = 4000 incr./rev.

C026 = - 0 -

C027 = 0.8192

C028 = 0.4000

Set-value conditioning of the slave

The value read from Dig_In_1, evaluated with C026, C027 and C028, forms the set-value (speed and phase) for the internal control and is also the output value at the digital frequency output.

The set-value for the corresponding drive can be evaluated by the gearbox factor C032 and C033.

The direction of the slave can be changed with the CW/CCW changeover. If the direction of rotation is changed while the machine is running, pulse losses, which

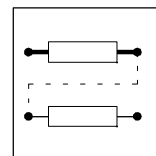

lead to phase errors occur. The direction changeover can, for instance, be used for electrical shafts, consisting of 2 opposite motors.

Special features compared to speed control

- No set-value integrator in the set-value branch.
- A changeover to a JOG value is not possible.
- The additional set-value is not active.

Feedback system (X7)

With configuration C005 = -72- only the resolver can be selected as feedback system.

QSP at the slave

If QSP is switched at the slave, the set-value (C050) is reduced along the QSP ramp. Homing points are lost. A driftfree standstill is obtained because with the switching of QSP the set phase is led by the QSP integrator.

If the deceleration ramp is very short and it can only be achieved with I_{max} the set-value integrator follows the actual phase integrator. Thus, the rotor does not turn back when reaching $n = 0$. If the I_{max} message is reset, the phase control will be reactivated and drift-free standstill can be ensured.

At the DF output, the set-value for the following slave(s) is still output.

Ctrl. enable at the slave

If a slave is inhibited, the motor coasts at the friction torque. At the digital frequency output, the set-value for the following slave is still output. If the slave is enabled, the drive accelerates to its set-value (possibly at the current limit).

When the controller is enabled, the phase difference is set to zero. Homing points are lost.

Exception

If the controller is inhibited because of a short-term synchronisation fault or mains undervoltage, the phase difference will not be reset. After mains recovery, the drive is able to follow its set phase. A phase difference, detected before, will be compensated.

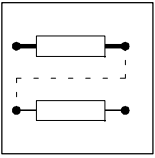

Configuration

7.3.4 Digital frequency output

DF output at the master

The following formula applied to the DF output:

$$\text{Output frequency [Hz]} = \frac{1}{60} C030 \left[\frac{\text{Incr.}}{\text{Rev.}} \right] \cdot \text{Set speed [rpm]}$$

The max. output frequency is: f_{\max} 420kHz
(corresponds to 3080 rpm with encoder type 8192 incr./rev.)

DF output at the digital frequency cascade

The signal read in at X5 and evaluated with C026, C027 and C028 is output at the DF output.

$$\text{Output frequency [Hz]} = \frac{1}{60} C030 \left[\frac{\text{Incr.}}{\text{Rev.}} \right] \cdot \text{Set speed [rpm]}$$

The max. output frequency is: f_{\max} 420kHz
(corresponds to 3080 rpm with encoder type 8192 incr./rev.)

DF output at the digital frequency bar

The signal at X9 (hardware) is directly output with a gain at X8 (encoder output).

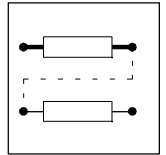

7.3.5 Speed synchronism

Selection

For speed synchronising, select the following slave configurations together with the master configuration C005 = -5X-:

- Slave for set-value bar C005 = -6X-
for only two drives or with fixed speed ratios which have to be set only once (commissioning).
- Slave for set-value cascade C005 = -72-
for more than two drives or simple modification of the speed ratios with stretch factors in the actual process.

The speed synchronism offset is changed and displayed under C257.

- The code can be accessed via analog terminal, motor potentiometer, keypad or LECOM.
- With this correction value, an offset up to 3750 rpm can be selected for the fixed speed ratio at the drive.

The phase controller must be deactivated for speed synchronism (C254 = 0). Thus, the phase-synchronous running becomes a speed-synchronous running, i.e. phase errors occur.

7.3.5.1 Speed-synchronous running

Purpose

For material transport with very low stretching coefficients, such as paper, metal, etc., the tension can be set through the gearbox factor under C032 and C033 because of the oversynchronisation in the ‰ range.

The stretch coefficient of the material results in a certain tension. For better operation and higher precision in digital frequency coupling, we recommend the digital frequency cascade C005 = -72-.

7.3.5.2 Speed ratio synchronism

Purpose

- Stretch systems
- Wire drawing systems

Example

Extruder systems with stretching of plastic threads by a speed ratio synchronism, with the stretching controlled by a motor potentiometer function on-line during the process (see chapter 15.7).

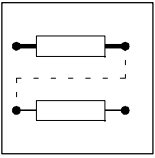

Configuration

7.3.6 Phase synchronisation

Purpose

- Drive concept for positive movements (e.g. packaging of bottles on conveyor belts).
- Electric shaft (e.g. line shaft, printing machines with size-dependent embossing rolls or printing rolls)

Conditions

Configuration C005 = -62-, -63- or -72-

With C005 = -52- or -53- the specifications are only valid for slave 0

Phase-synchronous running

With an active phase controller, every controller can perform a drift-free phase synchronisation to its set-value. Since for the DF cascade the set-value of the second slave was conditioned in the first slave and the two systems are not synchronised, a fixed phase shift between the motor shafts is caused, which however, does not add up over the time.

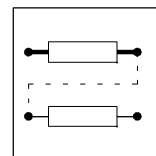

7.3.6.1 Phase controller

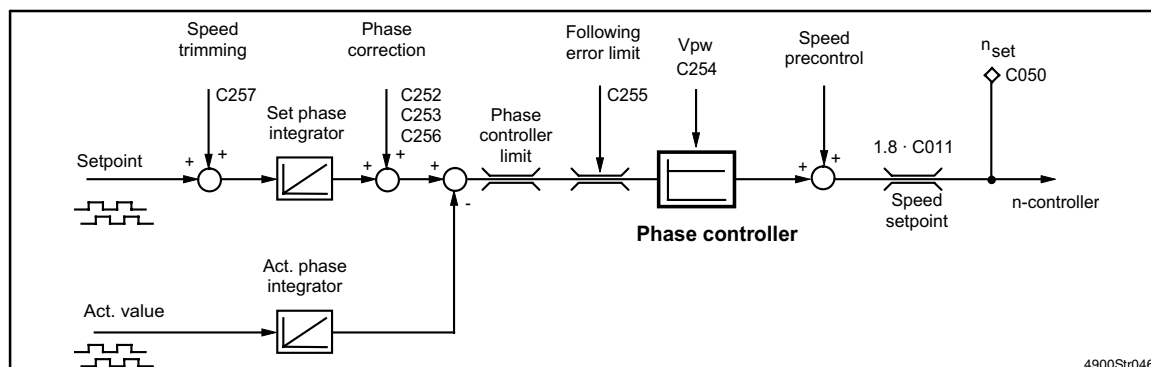

FIG 7-19 Phase controller

Conditions

Configuration C005 = -52-, -53-, -62-, -63- or -72-

Special features

With the configurations C005 = -12-, -13-, -42- or -43-, the activation of the phase controller ($C254 > 0$) during quick stop (QSP) ensures a drift-free standstill.

In continuous operation, the controller is not effective.

The difference calculated from set and actual phase is led to the phase controller which works as proportional controller. Its influence can be set under C254. $C254 = 0$ means the complete disconnection of the phase controller from the control path.

Setting range of C254 = 0.00 to 1.00. With $C254 = 1.00$ and 1 increment control difference, the phase controller changes the speed set-value by 0.186 rpm.

Phase controller limit



Stop!

When the phase controller limit is reached and the monitoring is switched off, the sign at the phase controller output may change. By switching controller enable, the phase difference is set to zero.

The phase controller limit is fixed to a phase difference of 65531 revolutions. If this phase difference is exceeded, the phase controller can no longer correct the set phase. When the phase controller limit is reached, a TRIP P13 is generated. The fault message can be evaluated in its priority.

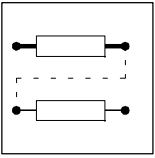

Configuration

7.3.6.2 Phase trimming

The phase trimming can be changed and displayed under C256.

- Code C256 can be accessed via analog terminal, motor potentiometer, one of the signal sources under C145, keypad or LECOM.
- Thus, the rotor position can be adjusted by a maximum of 4 revolutions. Negative values stand for an adjustment to the left and positive values for an adjustment to the right.

Resolution: 1 incr. ref. to an encoder type 8192 incr./rev.

7.3.6.3 Following error limit

The following error limit can be set under C255 in increments. The setting range is: 0...536.750.000 increments. The maximum value of the phase difference is 65.521 revolutions and does not depend on the encoder.

Hysteresis: 10 increments.

When the following error limit is reached, a signal is generated which is evaluated via the "monitorings". Thus, the priority (TRIP, message or warning) can be evaluated according to the user's requirements.

With switching controller enable, the phase difference is set to zero.

With an activated phase controller, phase synchronism and drift-free synchronous running with the controller set-value (the same as set-value of other controllers) can be achieved.

By means of gearbox factors (C032 and C033) in the corresponding drive it is possible to compensate for mechanically asymmetric operation of the system (e.g. different gearboxes). This means, that phase synchronism at the gearbox output shafts can be implemented.

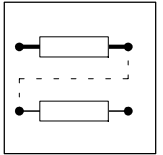

7.4 Additional control functions

7.4.1 Redundant actual value feedback

Purpose

In the event of a failure of the actual speed encoder like tacho, resolver or incremental encoder, this function enables to decelerate the DC drive standstill in a controlled way (emergency operation) without being inhibited by a TRIP.

Function

If the actual value encoder fails, it is changed to armature voltage feedback:

- Speed operation with configuration C005 = -1X-,
Change to configuration C005 = -10-.
- Torque control with configuration C005 = -4X-,
Change to configuration C005 = -40-.
- Dig. frequency operation with the configurations C005 = -5X-, -6X-, -7X-,
Change to configuration C005 = -10-.

The set-value channel remains active, i.e. a possibly selected phase control is not active.



Warning!

The message "encoder polarity reversed" does not automatically lead to a change of the actual value encoder to armature voltage control.

With the change to armature voltage control, the feedback resolution becomes less compared to a tacho or resolver. Furthermore, faults in speed adjustment (encoder constant) can occur.

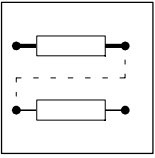

Configuration

Activation of redundant encoder feedback

The redundant encoder feedback is activated by a change of the monitoring, "Sd1" to "Sd4" depending on C005, from TRIP to warning (see chapter 7.7.1).



Warning!

In this case, the monitoring "armature circuit interrupted" (ACI) cannot detect an interruption of the armature circuit reliably.

Use the monitoring TRIP for commissioning. If the actual value encoder operates correctly, the monitoring can be changed from TRIP to warning and thus activate the redundant feedback.

Adjustment of the redundant feedback

An adjustment through C025, C026 and C027 is not necessary for the armature voltage control since the gain factor must always be calculated on-line because of the different actual value encoders.

If the system requires low speed errors when changing the load, the "I R compensation" should be adjusted (see chapter 7.1.2.1).

Change to the actual encoder

Change to the configuration active before if

- the controller is disconnected from the mains
- the controller is inhibited and no warning is active.

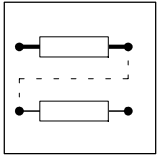

7.4.2 Changeable parameter sets

Up to four different parameter sets can be created, for instance, to process different materials with a machine or if different operating states (set-up operation, stand-by, etc.) require different parameter sets.

Programming of parameter sets

Follow these steps to program several parameter sets:

- Enter all settings required for your application.
- Select code C003 and store your parameter set e. g. under -1- (parameter set 1).
- Enter all settings required for another application (e. g. different material).
- Select code C003 and store this parameter set e. g. under -2- (parameter set 2) etc.

Code	Name	Possible settings		
		Lenze	Selection	Info
C003	Store parameter set	1	-1- Parameter set 1 -2- Parameter set 2 -3- Parameter set 3 -4- Parameter set 4	



Note!

If the function “Load parameter set” is assigned to a digital input, the controller evaluates the signal assigned to the input terminal.

Depending on the polarity, which is required for the activation of the input, selected under C114, the assignment of the new function may start the loading of a parameter set (RDY LED is off for approx. 1s).

Parameter changes carries out before and not stored under C003 are lost.

Parameter setting via keypad or LECOM interface:

1. For loading a parameter set under C114, select the polarity of the input such that the input is deactivated during point 2..
2. Assign function “Load parameter set”
3. Store parameter set under C003

For parameter transfer to the drive via LECOM interface ensure, that the parameter which selects the input polarity (C114) is set before the function assignment (C113) is transmitted.

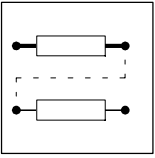

Configuration

The transfer of all parameter in rising sequence of code numbers is only possible if

- the parameter used to determine the input polarity is not be changed and
- the signal at the digital input does not lead to immediate activation of the function.

Load parameter set



Danger!

If the controller is not inhibited through control terminal 28, the drive can start operation when changing the parameter sets.

After mains switching, parameter set 1 is loaded automatically. If the parameter sets are to be changed via the digital inputs, at least one input of each parameter set must be assigned to "Select parameter set" and, if necessary, one input with "Load parameter set".

The number of inputs to be assigned with the function "Select parameter set" depends on the number of parameter sets to be changed.

Number of additionally required parameter sets	Number of inputs required
1	at least 1
2...3	2

A maximum of two inputs can be assigned to this function. For input assignment, see the notes in chapter 7.1.5.3.

The input with the lowest figure is the first input, the input with the next higher number is the second input (e. g. E1 = 1st input, E2 = 2nd input).

Terminal assignment for selection of different parameter sets:

	1. input	2. input
Parameter set 1	0	0
Parameter set 2	1	0
Parameter set 3	0	1
Parameter set 4	1	1

Loading of a parameter set is started if:

- another than parameter set 1 is selected when switching on the mains with the function "select parameter set".
- the input "load parameter set" is activated when the controller is inhibited and after control of the corresponding inputs for the selection of the required parameter sets.

The input "load parameter set" is signal triggered. If all parameters are loaded, C002 indicates the loaded parameter set.

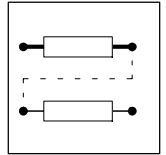

When the function "load parameter set" is activated, the controller cannot react on any other signal for approx. 1 second. Therefore, the "Ready message" (RDY) at terminal 44 will not be displayed for the time the controller cannot react on control signals (e.g. controller enable).

For control and parameter setting via the keypad or LECOM interfaces, a parameter set can be loaded via C002. Here, also default setting is available.

Code	Name	Possible settings		
		Lenze	Selection	Info
[C002]	Load parameter set	0	-0- Factory setting -1- Parameter set 1 -2- Parameter set 2 -3- Parameter set 3 -4- Parameter set 4	Parameter set 1 is automatically loaded after mains connection. If another parameter set is selected via terminal, the selected parameter set will be loaded additionally.

Default setting: Parameter set 2 for dancer position control

As application support, a parameter set for dancer position control at an unwinder with diameter precontrol is stored in parameter set 2 in default setting. This parameter set is meant as example for the adaptation to your application.

Changes compared with parameter set 1, default setting

Code	Parameter	Meaning
C000	-2-	Expanded code set
C005	-11-	Speed control with tacho feedback
C145	-4-	Select terminal 8
C146	-15-	Assign arithmetic block input 1 to terminal 8
C145	-3-	Select terminal 6
C146	-16-	Assign arithmetic block input 2 to terminal 6
C145	-10-	Select arithmetic block 2 output
C146	-1-	Assign arithmetic block 2 output main set-value to C046
C145	-9-	Select process controller output
C146	-3-	Assign additional set-value C049 to process controller output
C145	-1-	Select terminal 1,2
C146	-7-	Assign actual process controller value to terminal 1,2
C112	-3-	Select digital terminal E3
C113	-32-	Assign E3 to the process controller suppression
C112	-5-	Select digital terminal E5
C113	-31-	Assign E5 to suppress the I component of the process controller
C191	-4-	Arithmetic block 2: input1 / input2

Proceed as follows to activate this parameter set:

- C002 = -2-, load parameter set 2
- C003 = -1-, store under parameter set 1

After the adaptation and optimisation of the parameters, store the parameter set with C003.

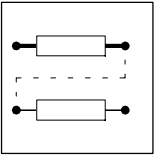

Configuration

7.4.3 4Q / 2Q changeover

Purpose

With a change to 2Q, the armature voltage V_A can be set to $1.15 V_{rated}$ instead of $1.05 V_{rated}$ in 4Q operation. The direction of rotation cannot be changed through the controller (if necessary, consider the change of the direction of rotation through active loads).

The changeover is carried out through code C180 of the extended code set when the controller is inhibited.

With the changeover:

- all set-value paths remain the same.
- the current limit C023 is internally set to 0. It is still possible to enter external values.
- only bridge 1 is active (motor terminal A is positive).
- the deceleration ramp C105 remains effective at QSP. However, no energy is fed back to the mains, i.e. the motor is coasting to standstill if the deceleration times are very short.



Stop!

With 48XX controller, the mode 4Q must not be selected. If the controllers 4808...4813 are set to 4Q operation, the fuses may blow.

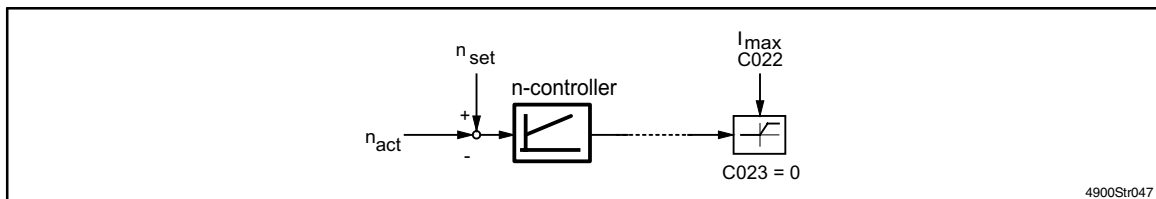
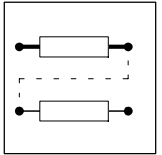

FIG 7-20 Signal-flow chart (section) for 2Q operation



7.4.4 Standstill excitation (field heating)

Purpose

With this function, a reduced field current can be set as field heating to avoid condensation in the event of motor standstill.

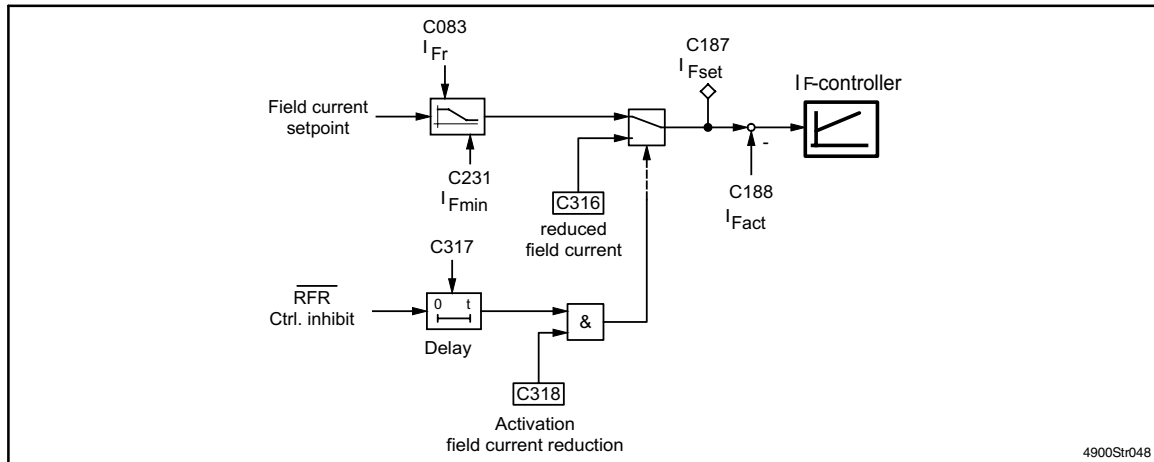
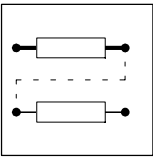

FIG 7-21 Standstill excitation

Code	Name	Possible settings				Info
		Lenze	Selection			
C316*	Reduced field current	20 %	0 % I_{Frated}	{ 1 % I_{Frated} }	100 % I_{Frated}	Reference: $I_{Frated}(C083)$ With selection 0%, the ignition pulses of the field controller are inhibited.
C317*	Time delay for the reduced field current	60 s	0.0 s	{ 0.1 s }	10 s	Time which is required to activate the reduced field current after inhibiting the controller.
C318*	Activate field current reduction	0	-0-	Field current reduction function is switched off		
			-1-	Field current reduction function is switched on		



Configuration

7.4.5 Control of a holding brake

Purpose

Control signal for holding brakes in:

- hoists
- travelling drives
- active loads

Code	Name	Possible settings			Info
		Lenze	Selection		
C019*	Threshold $n_{act} = 0$	50 rpm	0 rpm	{1 rpm} 5000 rpm	If the actual speed falls below the threshold, the corresponding output will be activated.
C195*	Delay between 'engage brake' and controller inhibit	9999 s	0.00s 1s 10s	{0.01 s} 1s {0.1s} 10s {1s} 250s 9999 s	Delay between signal 'engage brake' and automatic controller inhibit 9999 s: Unlimited delay, controller will not be inhibited.
C196*	Delay between 'setpoint integrator free' and quick stop	0.00s	0.00 s 1s 10s 100s	{0.01 s} 1 s {0.1s} 10s {1s} 100s {10s} 250s	Delay between reset of the quick stop function and enable of the main setpoint integrator
[C197*]	Sign of the torque selection	0	-0- -1- -2-	Sign is determined by the torque setpoint positive sign negative sign	Sign of the torque selection between reset of QSP and enable of the setpoint integrators
C244*	Threshold $ I_A > I_x$	10%	0 % I_{Amax}	{0.1% I_{Amax} } + 100 % I_{Amax}	$ I_A > I_x$ Reference, rated controller current (armature)
C245*	Threshold $I_F > I_x$	10%	0 % I_{Fmax}	{0.1% I_{Fmax} } + 100 % I_{Fmax}	$I_F > I_x$, Reference, rated controller current (field)
C317*	Time delay for the reduced field current	60 s	0.0 s 10 s 100 s	{0.1 s} 10 s {1 s} 100 s {10 s} 3600 s	Time which is required to activate the reduced field current after inhibiting the controller.
C318*	Activate field current reduction	0	-0- -1-	Field current reduction function is off Field current reduction function is switched on	

The function for the control of a holding brake only makes sense with the configurations C005 = -1X- and -5X-. The brake control is always derived from the QSP function.

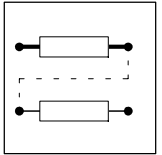

Configuration C005 = -12-, -13- (digital actual value encoder)

The phase controller is overlaid under the following conditions:

- QSP function active
- V_p of the phase controller (C254) higher 0

The I component of the speed controller must not be switched off via terminal or code because otherwise the drive cannot generate the required torque.

Configuration C005 = -10-, -11- (analog actual value controller)

The phase controller is usually not activated. If the value falls below the $n_{act}=0$ threshold (C019), the I component of the speed controller will be switched off. Otherwise the drive would add a torque to the engaged brake because of the offset values always available in analog systems.

Configuration C005 = -5X-

The phase controller is always active (if $C254 > 0$). A digital phase set-value is generated from the analog set-value. The drive operates phase controlled.

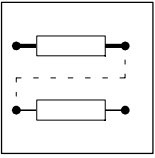

Configuration

7.4.5.1 Engage brake

The setting of QSP activates the function for the control of a holding brake. The speed set-value of the drive follows the deceleration ramp of QSP (C105) until reaching speed 0.

If the actual speed falls below the threshold C019, the control signal for the holding brake will be activated. At the same time, a time element is activated and after the time set under C195, the controller will be inhibited. This delay ensures that the drive provides a holding torque until the brake is reliably activated. Under C318 the field current can be reduced after the time set under C317.

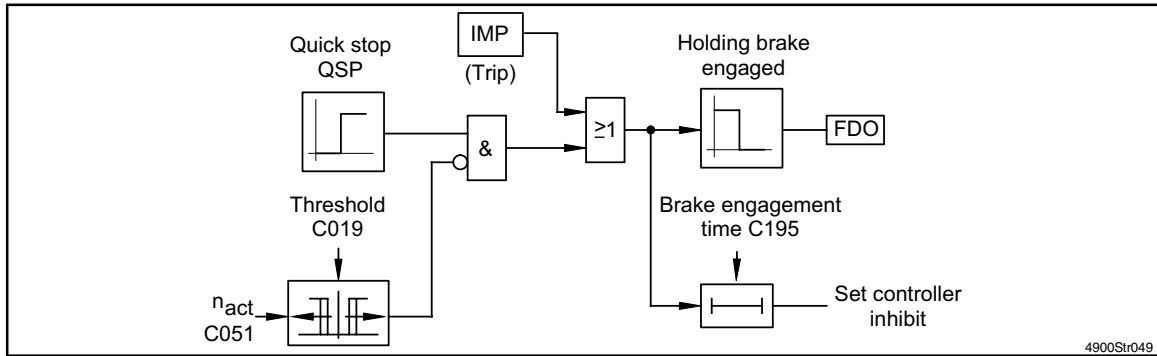

FIG 7-22 Block diagram 'Engage brake'

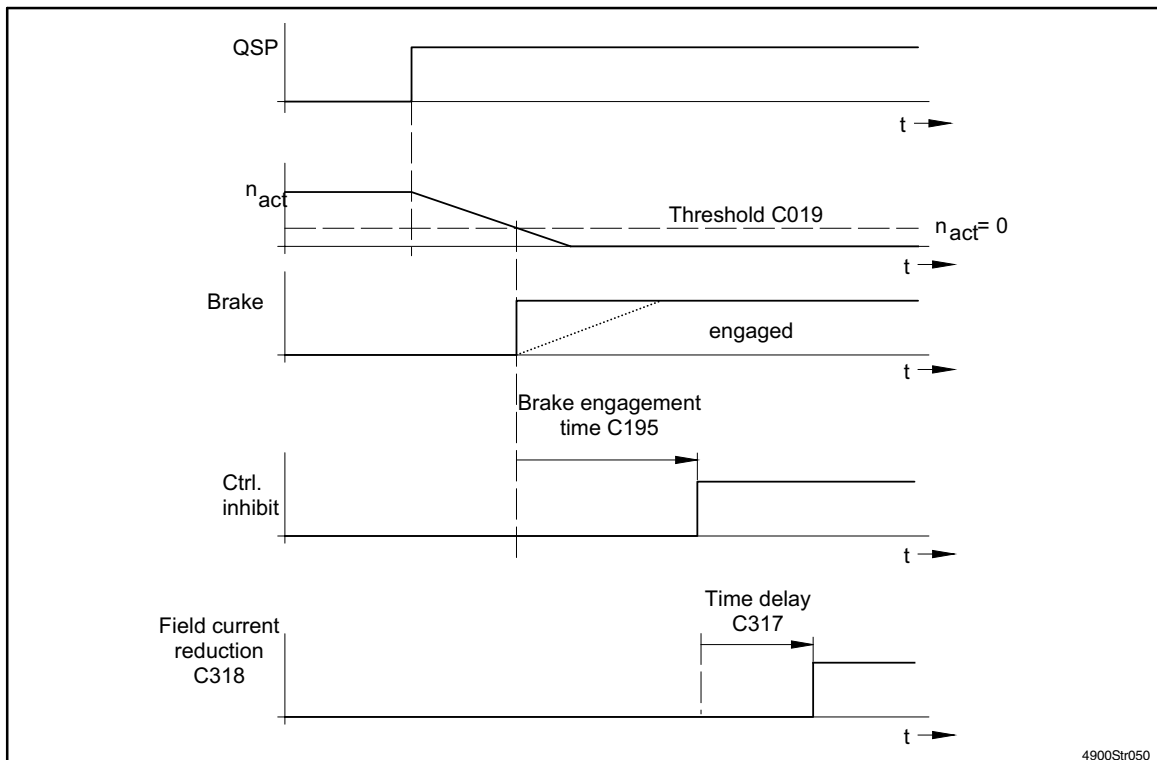
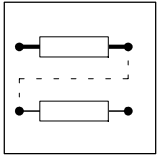

FIG 7-23 Time diagram 'Engage brake'



7.4.5.2 Open brake (release)

CW/CCW enable deactivates the internal controller inhibit immediately. At the same time, the field current reduction is reset. If the field current threshold (C245) is exceeded, the controller generates a torque or holding torque against the brake.

The drive provides the load torque while the brake is releasing. In phase-controlled operation the holding torque is generated through the I-component of the speed controller when a phase failure occurs. If the phase controller is not active (C005 = -10-, -11-) the holding torque is determined under C244.

CW/CCW enable activates a time element. After the time set under C196, the set-value integrator is enabled and the torque is determined by the speed controller again.



Note!

The function “release brake” is interrupted, if the speed exceeds the value set under C019. The controller immediately starts speed or phase controlled operation.

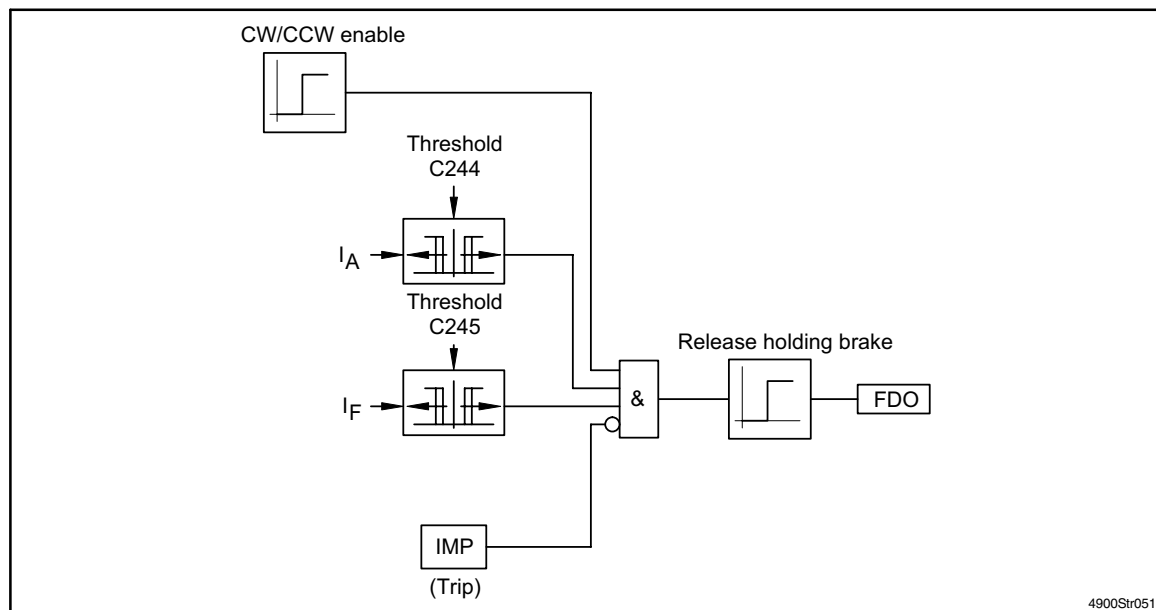
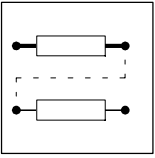
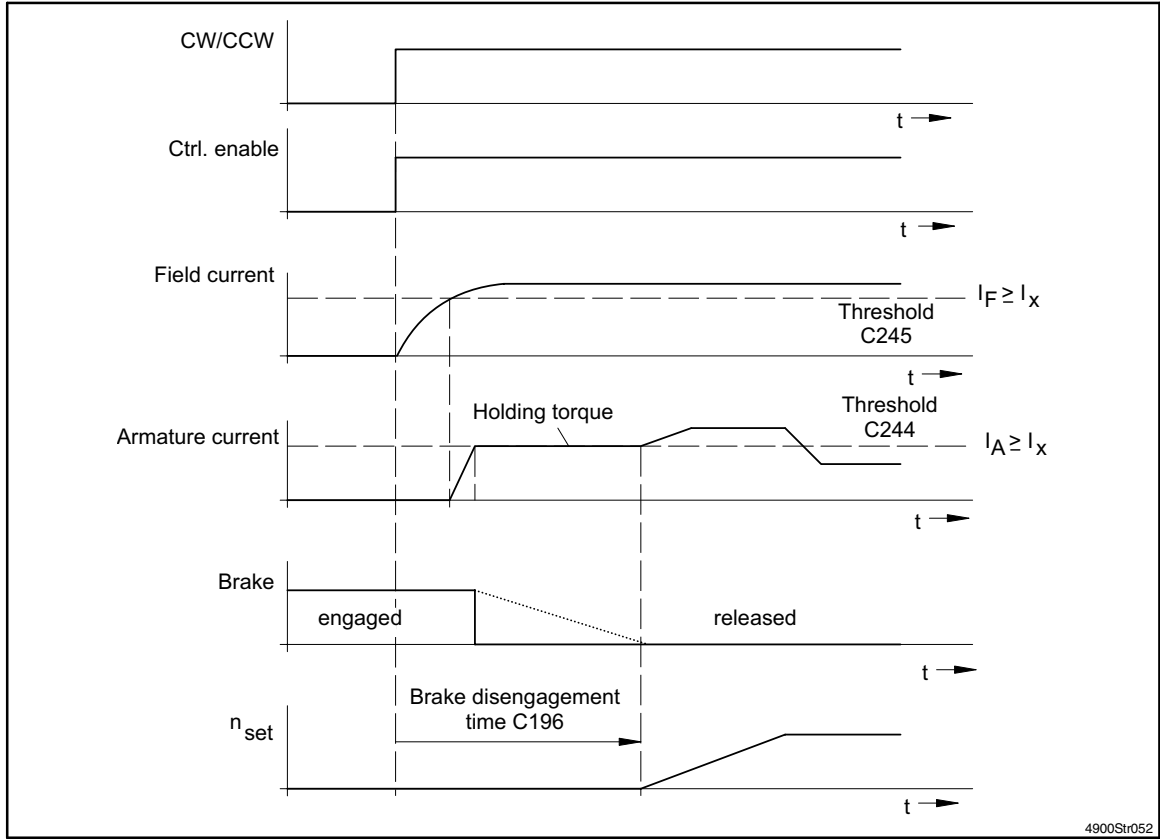

FIG 7-24 Block diagram 'Release brake'



Configuration



4900Str052

FIG 7-25 Time diagram 'Release brake'

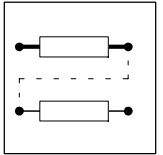

7.5 Additional function blocks

7.5.1 Process controller

Description

The process controller is designed as independent function block and is a PID controller with a cycle time of 12 ms.

It can for instance be used as superimposed controller (dancer position control, tension control, etc.).

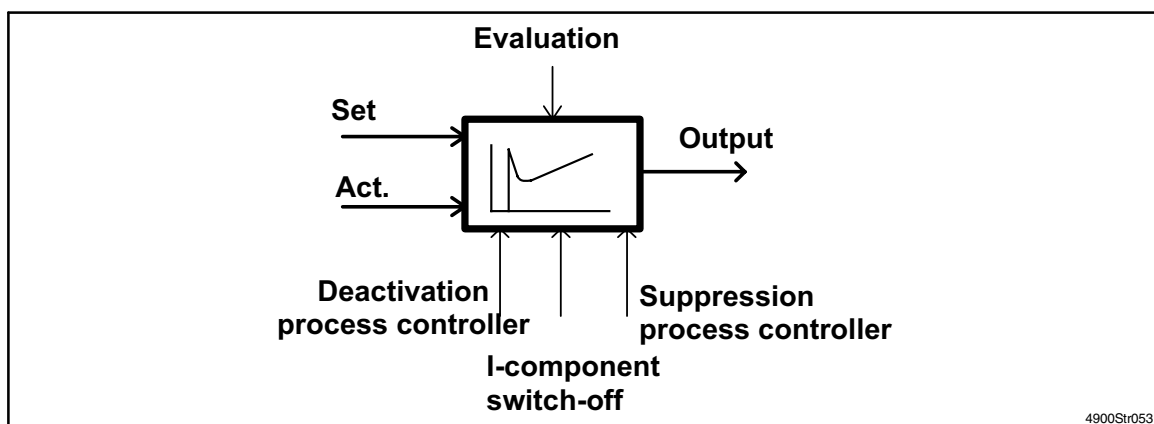
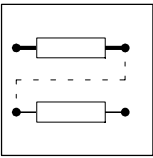

FIG 7-26 Process controller

Features

- P adaptation possible via an internal function (derived from set-value) or external analog signal source; enable adaptation with C329 = -1-
- Ramp function generator in set-value channel
- Overlay of process controller output over ramp function generator
- Integral action component to be switched-off via freely assignable digital terminal (I component = 0)
- Deactivation of the process controller via freely assignable digitale terminal (I component = 0, output = 0)
- Suppression of the process controller output via freely assignable digital terminal (output = 0 after time C335)



Configuration

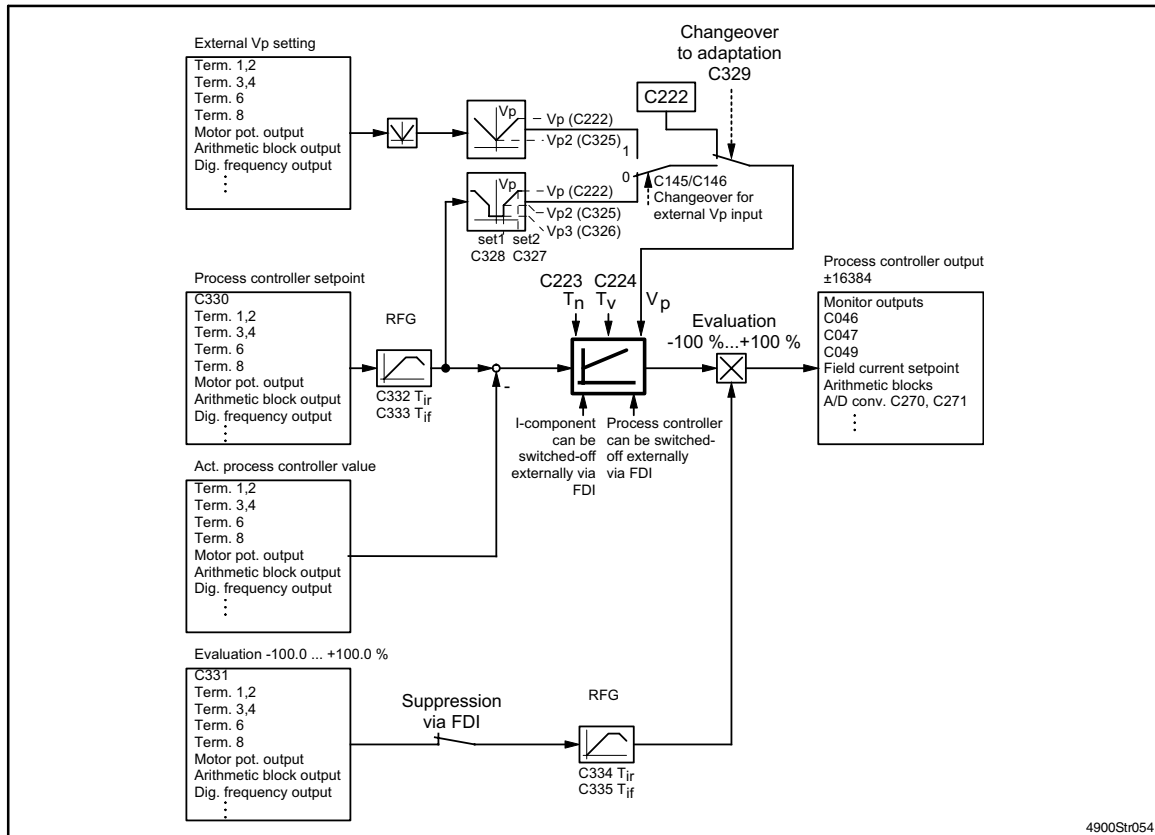

FIG 7-27 General signal structure of the process controller

Process controller inputs

1. Analog inputs

With the function "freely assignable analog inputs" (C145...C147) the process controller inputs "set", "act." and "evaluation" can be assigned to other signal sources (see table C145).

The inputs "set" and "evaluation" have their own codes (C330 and C331) and can be parameterised via keypad or interface. The setting via these codes is however only possible if these no signal inputs are assigned to these codes.

The inputs "set" and "act." represent the set-value and the actual value of the PID controller. They are adjustable up to $\pm 100\%$.

With the input "evaluation", the controller output can be weakened or inverted. Values up to $\pm 100\%$ are adjustable. With the evaluation 100%, all process controller influence is effective.

The inputs "set" and "evaluation" are connected to their own ramp function generator before being processed any further. Acceleration and deceleration times can be set separately (C332 to C335).

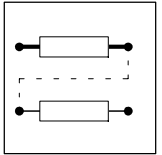

2. Digital inputs

The digital inputs of the process controller "Deactivate process controller", "Switch-off I component" and "Evaluation = 0" can be assigned to the FDIs 1 to 5.

The process controller is reset via the input "Deactivate process controller", i.e. the output jumps to zero and the I component is reset.

The input "Switch off I component" sets the I component of the controller to zero. The input "evaluation = 0" suppresses the process controller output.

Process controller outputs

With the function "freely assignable analog inputs" (C145 ... C147) the output of the process controller can be assigned to different targets (see table C146).



Note!

The output of the process controller cannot be directly assigned to the n controller adaptation. If this should be required, another function block can be connected in between (e.g. limitation element).

Example:

- C145 = -9- Select process controller output
- C146 = -23- Assign limitation element 1
- C145 = -19- Select limitation element 1 output 1
- C146 = -4- Assign n controller adaptation

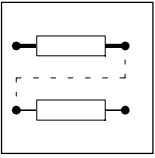

Configuration

7.5.2 Arithmetic blocks

Purpose

With the arithmetic blocks two different signals can be arithmetically connected to meet different application requirements.

Parameter setting

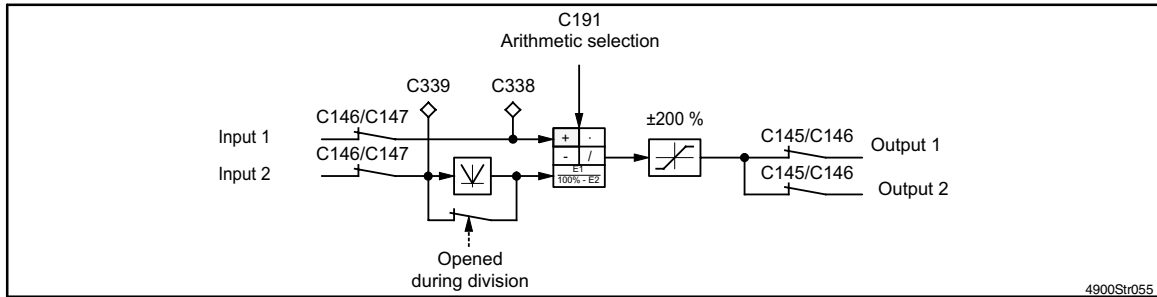

FIG 7-28 Arithmetic block 2

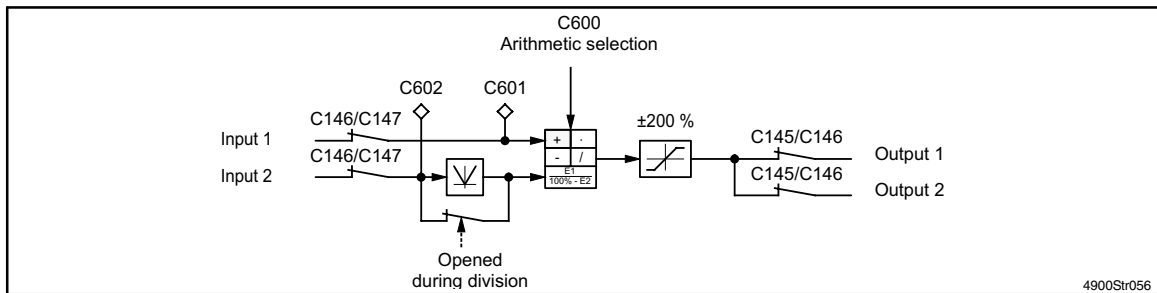

FIG 7-29 Arithmetic block 3

1. Inputs

With the function "freely assignable analog inputs" each input can be assigned to a "terminal signal" from the table in C145. If signals are assigned to the inputs, the input codes are for display only. If the inputs are not assigned, constant values can be assigned via the input codes. These values can also be save via C003.

2. Outputs

With the function "freely assignable analog inputs" (see code C146), arithmetic block outputs (signal sources) can be assigned to certain targets. If the arithmetic block is assigned to another input or code, the access to this code via keypad or interface is no longer enabled.

The output signal is limited to max. 200%.

The arithmetic blocks can also be output via the monitor output as analog voltage.

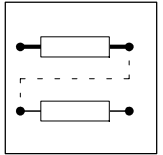

Example

The analog inputs terminal 8 and terminal 6 are to be connected (division) via the arithmetic block 2 and then be assigned to the code C046 "main set-value".

Procedure

- Select C145 = -4-, terminal 8
- Assign C146 = -14-, arithmetic block 2 input 1
- Select C145 = -3-, terminal 6
- Assign C146 = -15-, arithmetic block 2 input 2
- Select C145 = -10-, arithmetic block 2
- Assign C146 = -1-, main set-value (C046)
- C191 = -4-, division: select input 1 / input 2 (C338 / C339).

3. Functions

For all arithmetic blocks the following functions can be preselected (example for arithmetic block 2):

with C191 = -0-, output = C338 (C339 not processed)

with C191 = -1-, output = C338 + C339
100% = 50% + 50%

with C191 = -2-, output = C338 - C339
50% = 100% - 50%

with C191 = -3-, output = C338 · C339
100% = 100% · 100%

with C191 = -4-, output = C338 / |C339|
1% = 100% / 100%

with C191 = -5-, output = C338 / (100% - C339)
200% = 100% / (100% - 50%)

Arithmetic block 1 (fixed)

Code	Name	Possible settings		Info
		Lenze	Selection	
C190*	Arithmetic block 1	1	-0- Output = C046 -1- Output = C046 + C049 -2- Output = C046 - C049 -3- Output = C046 · C049 -4- Output = C046 / C049 -5- Output = C046 / (100% - C049)	

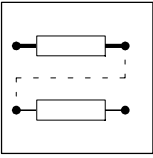

Configuration

Arithmetic block 2

Code	Name	Possible settings			Info	
		Lenze	Selection			
C191*	Arithmetic block 2	1	-0- -1- -2- -3- -4- -5-	Output = C338 Output = C338 + C339 Output = C338 - C339 Output = C338 / C339 Output = C338 / C339 Output = C338 / (100% - C339)		
C338*	Input 1, Arithmetic block 2	0%	-100.0 % -200 %	{0.1 %} {1 %}	100.0 % +200 %	If an analog signal source (C145/C146) is assigned, the parameter will be displayed only.
C339*	Input 2, Arithmetic block 2	0%	-100.0 % -200 %	{0.1 %} {1 %}	100.0 % +200 %	If an analog signal source (C145 / C146) is assigned, the parameter will be displayed only.

Arithmetic block 3

Code	Name	Possible settings			Info	
		Lenze	Selection			
C600*	Arithmetic block 3	1	-0- -1- -2- -3- -4- -5-	Output = C601 Output = C601 + C602 Output = C601 - C602 Output = C601 / C602 Output = C601 / C602 Output = C601 / (100% - C602)		
C601*	Input 1, arithmetic block 3	0%	-100.0 % -200 %	{0.1 %} {1 %}	100.0 % +200 %	If an analog signal source (C145/C146) is assigned, the parameter will be displayed only.
C602*	Input 2, arithmetic block 3	0%	-100.0 % -200 %	{0.1 %} {1 %}	100.0 % +200 %	If an analog signal source (C145 / C146) is assigned, the parameter will be displayed only.

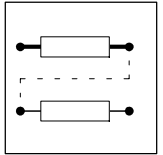

7.5.3 Motor potentiometer

Purpose

The motor potentiometer serves as alternative set-value source which can be controlled with 2 keys.

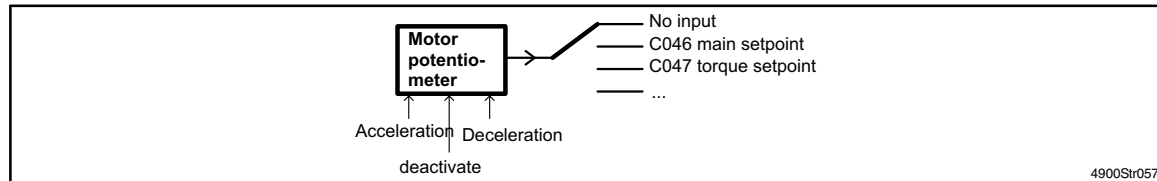

FIG 7-30 Motor potentiometer

The motor potentiometer is a function unit which can be assigned to different inputs.

With the function "freely assignable analog inputs" the motor potentiometer output can be assigned to the targets listed under C146.



Note!

The output of the motor potentiometer cannot be directly assigned to the field current set-value selection. If this should be required, another function block can be connected in between (e.g. limitation element).

Example :

- C145 = -8- Select motor potentiometer output
- C146 = -23- Assign limitation element 1
- C145 = -19- Select limitation element 1 output 1
- C146 = -5- Assign field-current set-value

The signal resolution is [14 bit] (-16384 ... +16384), except for the targets

C146 = -10- C027 of digital input X5

C146 = -11- C027 of digital input X9

C146 = -12- gearbox factor C032

C146 = -13- phase trimming C256

the controller works with a resolution of [15 bit-1] (-32767 ... +32767)

As soon as the motor potentiometer is assigned to an input or a code, the direct access to this codes is no longer possible.

The motor potentiometer output can also be output as analog voltage via the monitor output.

The output value of the motor potentiometer is displayed under the code (e.g. C046, C047) assigned to the motor potentiometer. The functions ctrl. inhibit, TRIP and QSP have no influence on the motor potentiometer because it is an independent block.

After motor potentiometer activation all other control functions remain active.

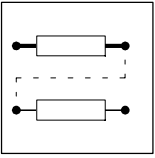

Configuration

If the motor potentiometer acts on the main set-value C046, QSP, the ramp function generator of the main set-value, JOG enable and CW/CCW changeover have priority.

7.5.3.1 Control of the motor potentiometer

- If the terminal signal "acceleration" is active, the ramp function generator (RFG) accelerates to its upper limit value (C260).
- If the terminal signal "deceleration" is active, the RFG decelerates to its lower limit value (C261).
- The existing RFG content remains the same as long as none of the signals is active.

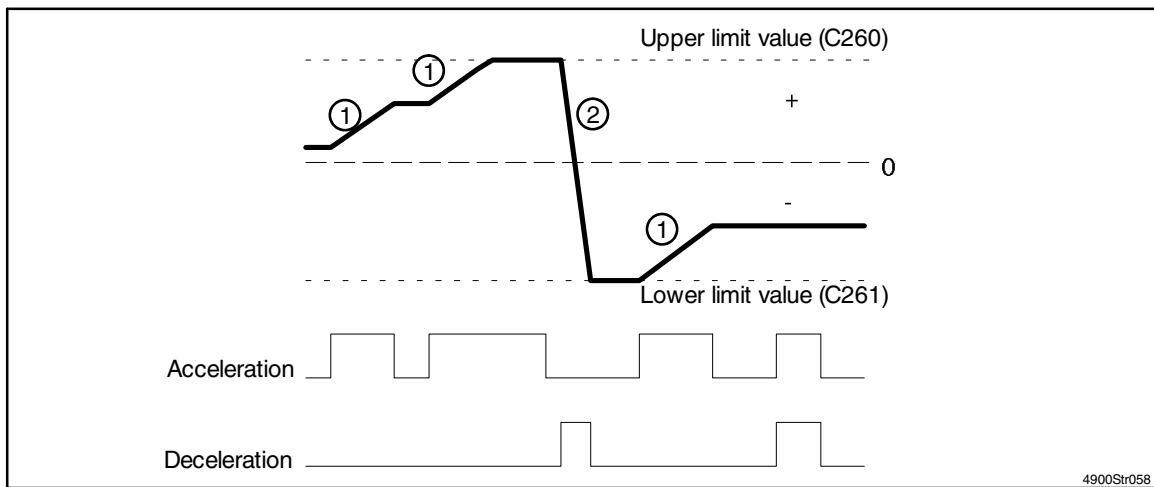

FIG 7-31 Signal flow at the motor potentiometer output

①	Acceleration ramp depends on acceleration time C262
②	Deceleration ramp depends on deceleration time C263

In addition to the two input terminals "acceleration" and "deceleration" there is another terminal which enables the activation and deactivation of the motor potentiometer.

If the motor potentiometer is activated, the output accepts the signal value assigned to be input before. If the signal value is not within the motor potentiometer limit, it will be reduced to the corresponding limit value (depending on the acceleration and deceleration time).

If the motor potentiometer is deactivated, its output reacts as selected under C264.

- 0 -	No further action, value is stored
- 1 -	The motor potentiometer decelerates or accelerates to 0%.
- 2 -	The motor potentiometer decelerates or accelerates to the lower limit value (C261).
- 3 -	The motor potentiometer immediately changes its output to 0% (important for the emergency-switch-off function)
- 4 -	The motor potentiometer immediately changes its output to the lower limit value (C261).
- 5 -	The motor potentiometer decelerates or accelerates to the upper limit value (C260).

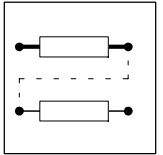

Initialisation

When switching off the mains, the output value of the motor potentiometer is stored in the EEPROM. Select under code C265 whether the motor potentiometer accepts the stored value or the lower limit value when starting after mains connection.

The EEPROM is designed for a minimum of 40.000 mains connection cycles.

7.5.3.2 Memory function of the motor potentiometer (S&H)

Purpose

The memory function of the motor potentiometer (sample and hold, S&H) can be reassigned to a freely assignable analog input (FAI). It is thus possible to store a signal stored under C145 when switching the mains.

Note:



Note!

For this function, the deactivation and the initialisation function of the motor potentiometer is used, i.e. the motor potentiometer can no longer be used when switching to a FAI signal.

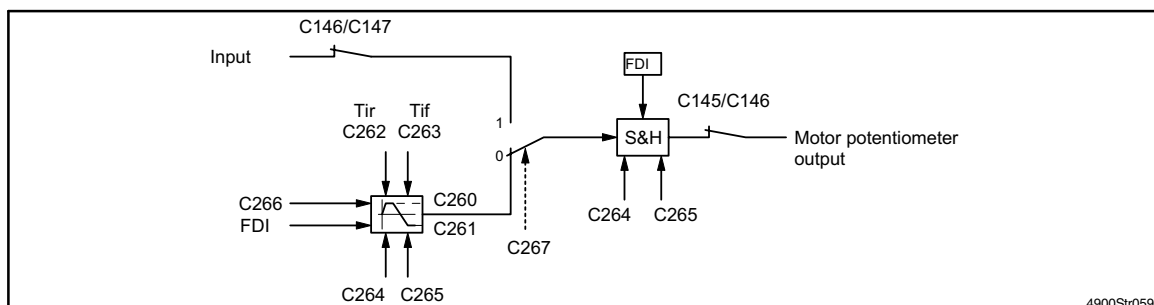
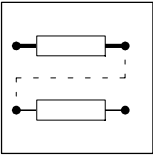

FIG 7-32 Motor potentiometer with S&H function

With the function "Deactivate motor potentiometer" via FDI (C113) the hold function is activated. A change of the input value does not influence the output any longer. When switching the mains, the value stored last is transferred to the EEPROM and is available when switching on the mains again.

The initialisation function is however dependent on the codes C264 and C265.



Configuration

Code	Name	Possible settings				Info
		Lenze	Selection			
C260*	Upper motor potentiometer limit	100%	-100.0 %	{0.1 %}	+100.0 %	C260 must be higher than C261!
C261*	Lower motor potentiometer limit	0 %	-100.0 %	{0.1 %}	+100.0 %	C261 must be smaller than C260!
C262*	Motor potentiometer acceleration time	10 s	1 s	{1 s}	5000 s	C262 is activated if the motor potentiometer terminal is set to "UP" Ref.: Change from 0... 100%
C263*	Motor potentiometer deceleration time	10 s	1 s	{1 s}	5000 s	C263 is activated if the motor potentiometer terminal is set to "DOWN" Ref.: Change from 0... 100%
C264*	Motor potentiometer deactivation function	0	-0- -1- -2- -3- -4- -5-	No function, motor potentiometer is not changed. Down to 0%, motor potentiometer output runs with the corresponding acceleration or deceleration time to 0%. Down to lowest limit, motor potentiometer output runs with the corresponding acceleration or deceleration time to the value under C261. Jump to 0%, motor potentiometer output immediately changes to 0%. Jump to the lowest level, motor potentiometer immediately changes to the value indicated under C261. Up to the highest level, motor potentiometer output runs with the corresponding acceleration or deceleration to the value indicated under C260.		Function, which is executed when deactivating the motor potentiometer (terminal DEACTIVE is set).
C265*	Initialisation function Sample & Hold	0	-0- -1-	Acceptance of the saved value S&H output accepts the value which was set before switching the mains. Lower limit, S&H output accepts the value of C261.		Function which is executed when switching on the mains.
C266*	Motor potentiometer: Operation via keypad		100 %	{0.1 %}	+100 %	Under C266 the motor potentiometer can also be operated with sand t. Display: Output value of the motor potentiometer in % and exact control program value.
C267*	Sample and Hold function	0	-0- -1-	S&H for motor potentiometer output S&H für FAI signal		

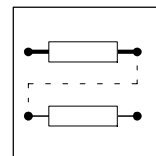

7.5.4 Fixed set-value

Purpose

The function block "fixed set-values" is used to program a maximum of 15 fixed setpoints and to call them via digital terminals or control codes.

These fixed setpoints can be used e.g. for:

- Different dancer set positions when a dancer position control is used or
- Different stretch conditions (gearbox factor) when a speed ratio control with digital frequency coupling is used.

Function

"Fixed set-values" are independent function blocks. Their outputs can be used as set-value source for other function blocks (e.g. process controller, arithmetic block, ...). The parameter setting is the same as for the JOG values. The function block provides another freely assignable analog input (FAI), which is assigned to the output if none of the 15 fixed set-values is selected via C194 or the control word includes a 0.

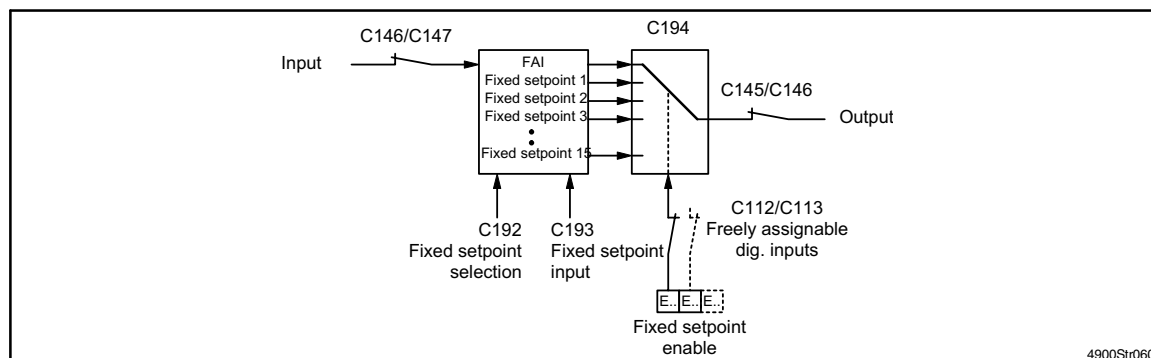

FIG 7-33 Fixed set-values

Parameter setting of the fixed setpoints

Similar to the JOG values, the parameters are set via 2 codes.

- Select the fixed set-value to be parameterised under C192
- Change or set the value under C193

The fixed set-values are selected and parameterised via the keypad or the LECOM interface.

Output of the selected fixed setpoint

The output of the fixed set-values depends on the parameter under C194, the control word. Via this code always a on fixed set-value is assigned to the output. This code is controlled via keypad, LECOM or freely assignable digital inputs (operating mode C001). The function block output is assigned under codes C145/C146.

Normalisation

The values for the fixed set-value range between -100% and +100%.

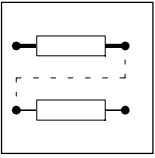

Configuration

7.5.5 Absolute value generator

Purpose

Bipolar signals can be converted into unipolar signals.

Parameter setting

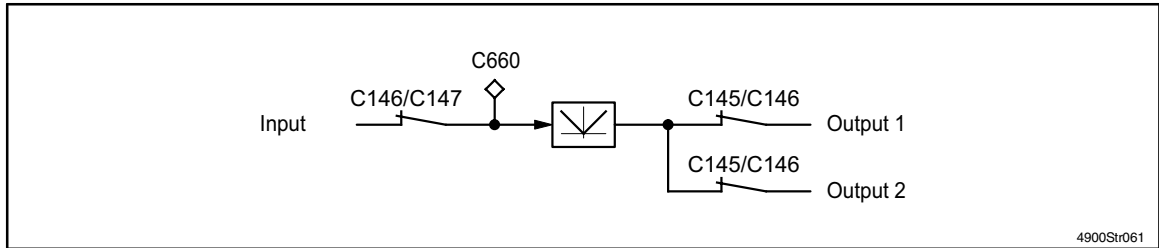

FIG 7-34 Absolute value generator

1. Input

With the function "freely assignable analog inputs" each input can be assigned to a "terminal signal" from the table in C145.

2. Outputs

With the function "freely assignable analog inputs" the outputs can be assigned to the targets listed under C146.

3. Function

The absolute value of the input signal is generated.

Code	Name	Possible settings				Info
		Lenze	Selection			
C660*	Input, absolute value generator	0 %	-100.0 %	{0.1 %}	100.0 %	Display parameter only
			-200 %	{1 %}	+200 %	

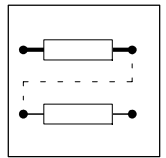

7.5.6 Limitation elements

Purpose

The controller provides two limitation elements. With these function blocks signals can be limited to adjustable value ranges.

Parameter setting

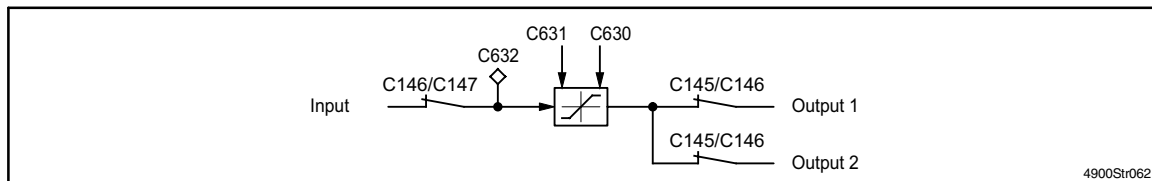

FIG 7-35 Limitation element 1

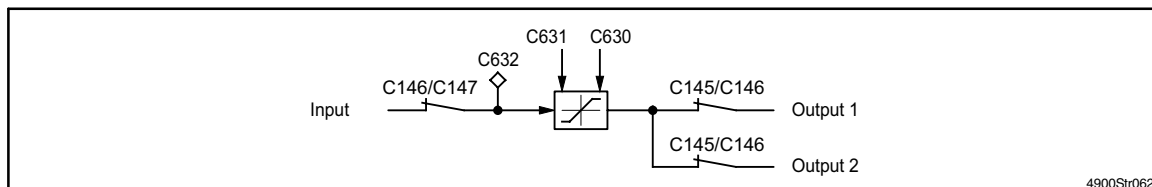

FIG 7-36 Limitation element 2

1. Input

With the function "freely assignable analog inputs" each input can be assigned to a "terminal signal" from the table in C145.

2. Outputs

With the function "freely assignable analog inputs" the outputs can be assigned to the targets listed under C146.

3. Function

The function is an override function. If the input signal exceeds the upper limit (C630 or C635), the upper limit is effective. If the input signal falls below the lower limit (C631 or C636), the lower limit is effective.

Code	Name	Possible settings				Info
		Lenze	Selection			
C630*	LE 1 upper limit	100 %	-100.0 % -200 %	{0.1 %} {1 %}	100.0 % +200 %	C630 must be higher than C631!
C631*	LE 1 lower limit	-100 %	-100.0 % -200 %	{0.1 %} {1 %}	100.0 % +200 %	C631 must be smaller than C630!
C632*	Input, LE 1	0 %	-100.0 % -200 %	{0.1 %} {1 %}	100.0 % +200 %	Display parameter only
C635*	LE 2 upper limit	100 %	-100.0 % -200 %	{0.1 %} {1 %}	100.0 % +200 %	C635 must be higher than C636!
C636*	LE 2 lower limit	-100 %	-100.0 % -200 %	{0.1 %} {1 %}	100.0 % +200 %	C636 must be smaller than C635!
C637*	Input, LE 2	0 %	-100.0 % -200 %	{0.1 %} {1 %}	100.0 % +200 %	Display parameter only

Abbreviation: LE = Limitation element

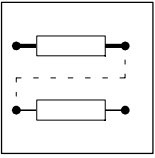

Configuration

7.5.7 PT1 element

Purpose

Signals can be filtered with this function block.

Parameter setting

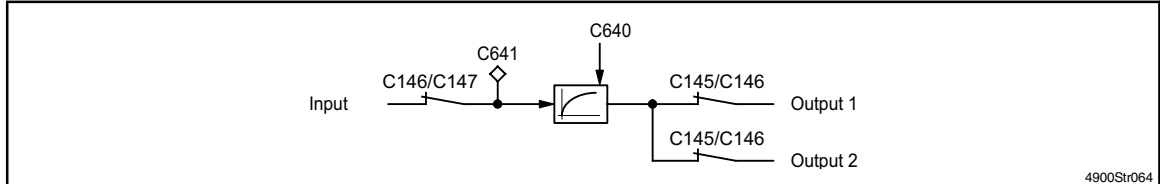

FIG 7-37 1st order delay element (PT1 element)

1. Input

With the function "freely assignable analog inputs" each input can be assigned to a "terminal signal" from the table in C145.

2. Outputs

With the function "freely assignable analog inputs" the outputs can be assigned to the targets listed under C146.

3. Function

The delay time T is set under C640. The proportional coefficient is determined as $K = 1$.

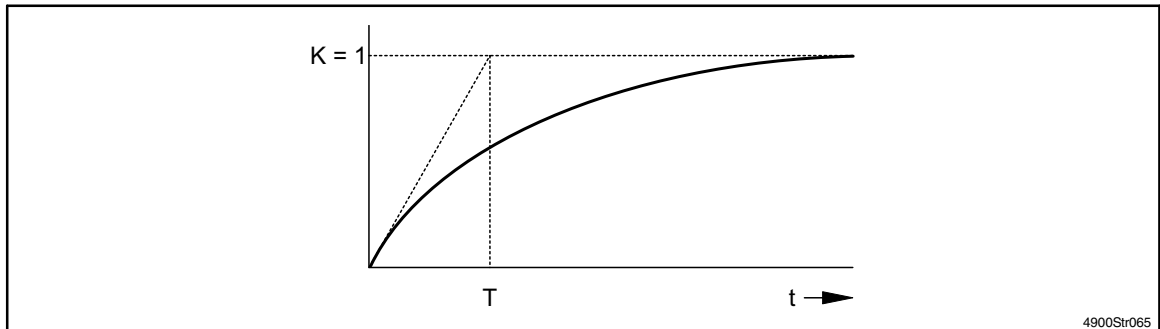
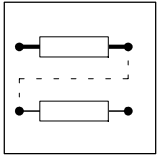

FIG 7-38 Transfer characteristic of the PT1 element

Code	Name	Possible settings				Info
		Lenze	Selection			
C640*	PT1 element Time constant	20.00s	0.01 s 1 s 10 s	{0.01 s} {0.1 s} {1 s}	1 s 10 s 50 s	
C641*	Input, PT1 element	0 %	-100.0 % -200 %	{0.1 %} {1 %}	100.0 % +200 %	Display parameter only



7.5.8 Addition

Purpose

The controller provides two addition facilities with three inputs each. Here, analog signals can be added or subtracted.

Parameter setting

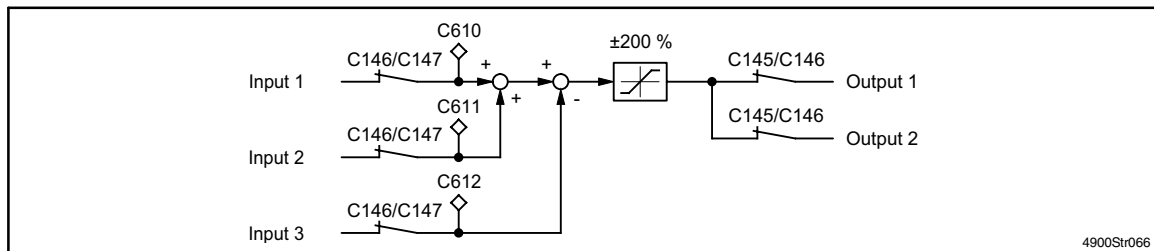

FIG 7-39 Addition 1

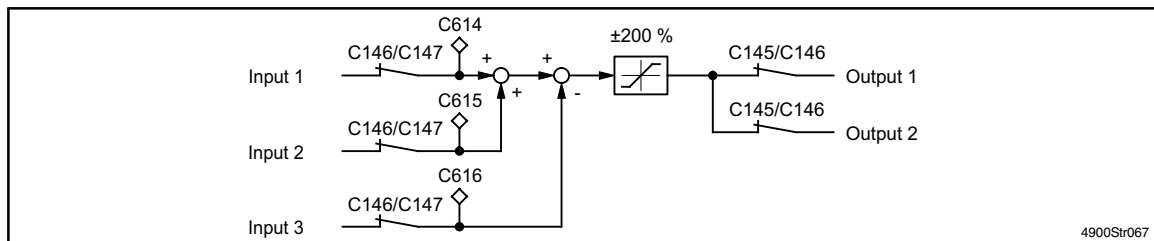

FIG 7-40 Addition 2

1. Input

With the function "freely assignable analog inputs" each input can be assigned to a "terminal signal" from the table in C145. If signals are assigned to the inputs, the input codes are for display only. If the inputs are not assigned, constant values can be assigned via the input codes. These values can also be stored via C003.

2. Outputs

With the function "freely assignable analog inputs" the outputs can be assigned to the targets listed under C146.

3. Function

Input 1 is added to input 2. Input 3 is subtracted from the calculated result. Then, the value is limited to $\pm 200\%$.

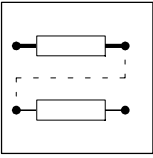

Configuration

Addition 1:

Code	Name	Possible settings				Info
		Lenze	Selection			
C610*	Input 1, addition block 1	0%	-100.0 % -200 %	{0.1 %} {1 %}	100.0 % + 200 %	If an analog signal source (C145/C146) is assigned, the parameter will be displayed only.
C611*	Input 2, addition block 1	0%	-100.0 % -200 %	{0.1 %} {1 %}	100.0 % + 200 %	If an analog signal source (C145/C146) is assigned, the parameter will be displayed only.
C612*	Input 3, addition block 1	0%	-100.0 % -200 %	{0.1 %} {1 %}	100.0 % + 200 %	If an analog signal source (C145 / C146) is assigned, the parameter will be displayed only.

Addition 2:

Code	Name	Possible settings				Info
		Lenze	Selection			
C614*	Input 1, addition block 2	0%	-100.0 % -200 %	{0.1 %} {1 %}	100.0 % + 200 %	If an analog signal source (C145/C146) is assigned, the parameter will be displayed only.
C615*	Input 2, addition block 2	0%	-100.0 % -200 %	{0.1 %} {1 %}	100.0 % + 200 %	If an analog signal source (C145/C146) is assigned, the parameter will be displayed only.
C616*	Input 3, addition block 2	0%	-100.0 % -200 %	{0.1 %} {1 %}	100.0 % + 200 %	If an analog signal source (C145 / C146) is assigned, the parameter will be displayed only.

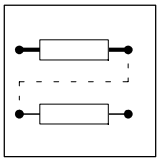

7.5.9 Square-wave generator

Purpose

The square-wave generator accepts jump responses from the control circuits.

Parameter setting

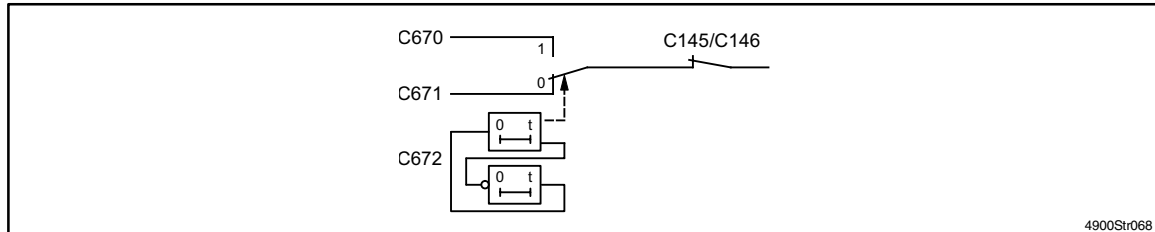

FIG 7-41 Square-wave generator

1. Input

The amplitude is set under C670 (upper value) and C671 (lower value).

2. Outputs

With the function "freely assignable analog inputs" the output can be assigned to the targets listed under C146.

3. Function

The transfer time is set under code C672. The period results from $T = 2 \cdot C672$.

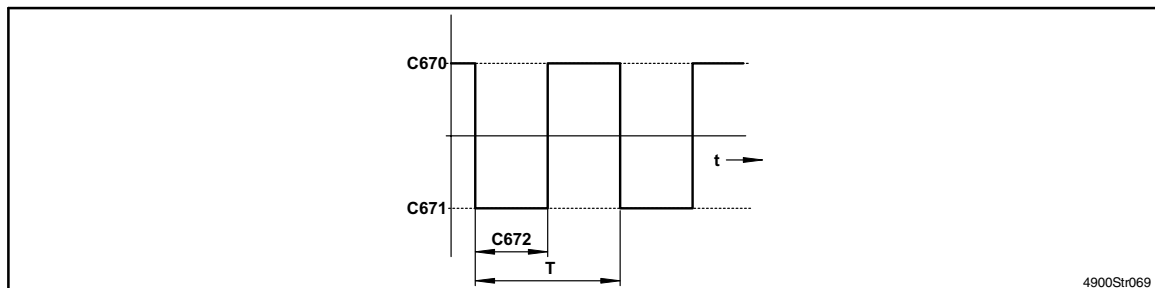
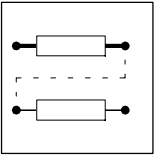

FIG 7-42 Signal flow at the square-wave generator

Code	Name	Possible settings				Info
		Lenze	Selection			
C670*	Square-wave generator upper limit	0 %	-100.0 %	{0.1 %}	+100.0 %	C670 must be higher than C671!
C671*	Square-wave generator lower limit	0 %	-100.0 %	{0.1 %}	+100.0 %	C671 must be smaller than C670!
C672*	Switch-over time of the square-wave generator	0.1 s	0.1 s 10 s 100 s	{0.1 s} {1 s} {10 s}	10 s 100 s 3000 s	



Configuration

7.5.10 Dead-band element

Purpose

The dead-band element is used to set interferences around the zero point (e.g. interference on analog input voltages) to digital zero.

Parameter setting

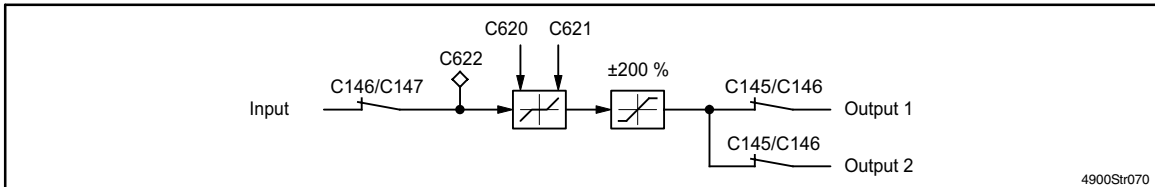

FIG 7-43 Dead-band element

1. Input

With the function "freely assignable analog inputs" each input can be assigned to a "terminal signal" from the table in C145.

2. Outputs

With the function "freely assignable analog inputs" the outputs can be assigned to the targets listed under C146.

The output signal is limited to max. 200%.

3. Function

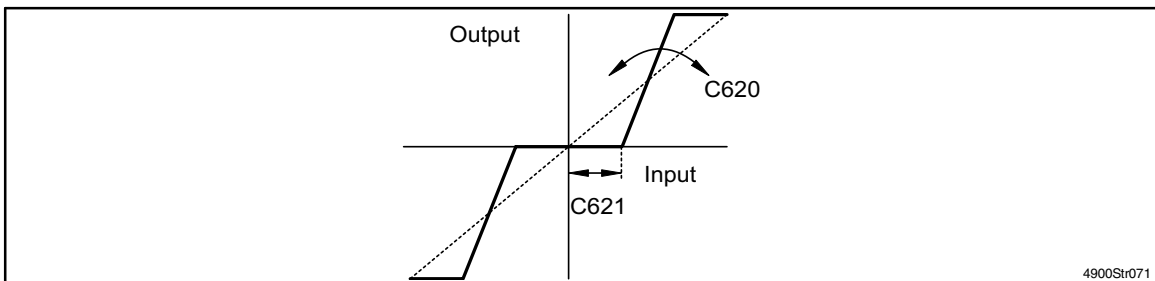
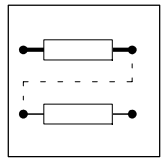

FIG 7-44 Characteristic for the dead-band element

Code C621 determines the dead band. The gain is set under code C620. The function is symmetrical to the zero position.

Code	Name	Possible settings				Info
		Lenze	Selection			
C620*	Gain dead band element	1.00	-10.00	{0.01}	+ 10.00	
C621*	Dead band, dead band element	1.0 %	0.0 %	{0.1 %}	100.0 %	
C622*	Input, dead band element	0%	-100.0 % -200 %	{0.1 %} {1 %}	100.0 % + 200 %	Display parameter only



7.5.11 DT1 element

Purpose

The DT1 element is to differentiate signals. It can, for instance, be used for acceleration compensation (dv/dt).

Parameter setting

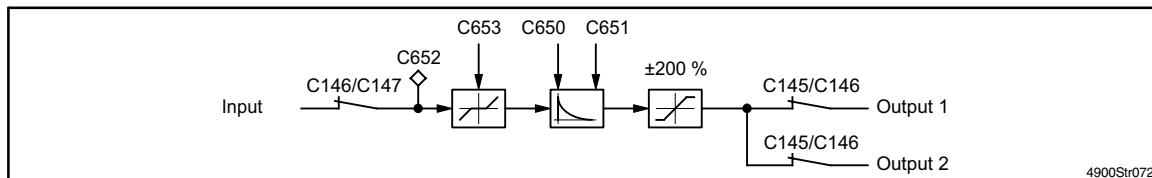

FIG 7-45 1st order derivative element (DT1 element)

1. Input

With the function "freely assignable analog inputs" each input can be assigned to a "terminal signal" from the table in C145.

2. Outputs

With the function "freely assignable analog outputs" the outputs can be assigned to the targets listed under C146. The same signal is assigned to both outputs. The output signal is limited to max. 200%.

3. Function

The gain K is set under code C650, the delay time T_v is set under C651. The input sensitivity of the DT1 element can be reduced under C653, i.e. according to the settings, only the high-value bits indicated are evaluated.

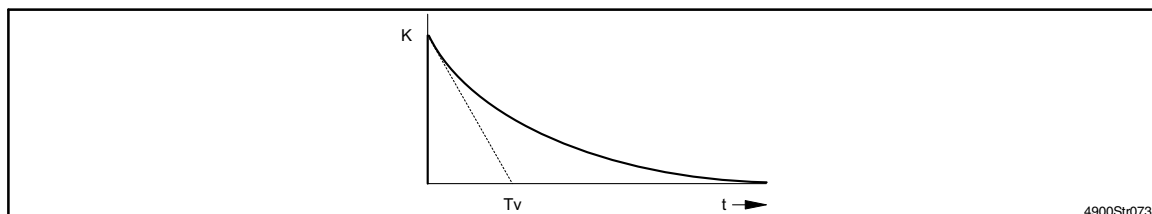
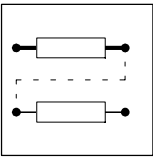

FIG 7-46 Transfer characteristic of the DT1 element

Code	Name	Possible settings				Info
		Lenze	Selection			
C650*	Gain	1.00	-10.00	{0.01}	+10.00	
C651*	Time constant	1.0 s	0.01 s	{0.01 s}	1.00 s	
			1.0 s	{0.1 s}	5.0 s	
C652*	Input	0 %	-100.0 %	{0.1 %}	100.0 %	Display parameter only
			-200 %	{1 %}	+200 %	
C653*	Input sensitivity		-1-	15 bit evaluation		
			-2-	14 bit evaluation		
			-3-	13 bit evaluation		
			-4-	12 bit evaluation		
			-5-	11 bit evaluation		
			-6-	10 bit evaluation		
			-7-	9 bit evaluation		



Configuration

7.5.12 Freely assignable comparator

The freely assignable comparators generate a digital output signal which depends on the analog input signals.

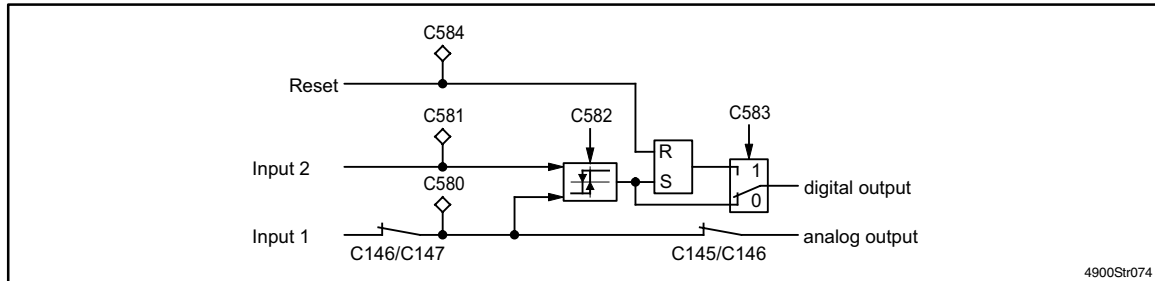

FIG 7-47 Comparator 1

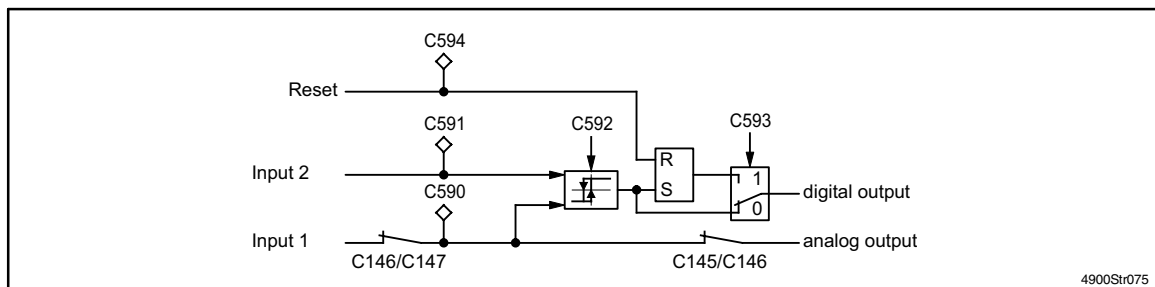

FIG 7-48 Comparator 2

Inputs:

With the function "freely assignable inputs" each analog input of the comparator can be assigned to a "terminal signal" from the table according to C145. The input values are compared in the range of 200 %.

With the function "freely programmable digital inputs", the reset input can be connected with a signal source according to the table under code C112.

"Analog" output:

With the function "freely assignable inputs" the inputs C580 for comparator 1 and C590 for comparator 2 can be used for further processing tasks. It is possible, for example, to compare the signal at the analog input terminal 8 with a limit value and provide the main set-value.

"Digital" output:

With the function "freely assignable digital outputs", the result of the comparator can be assigned to an output according to the table under C116.

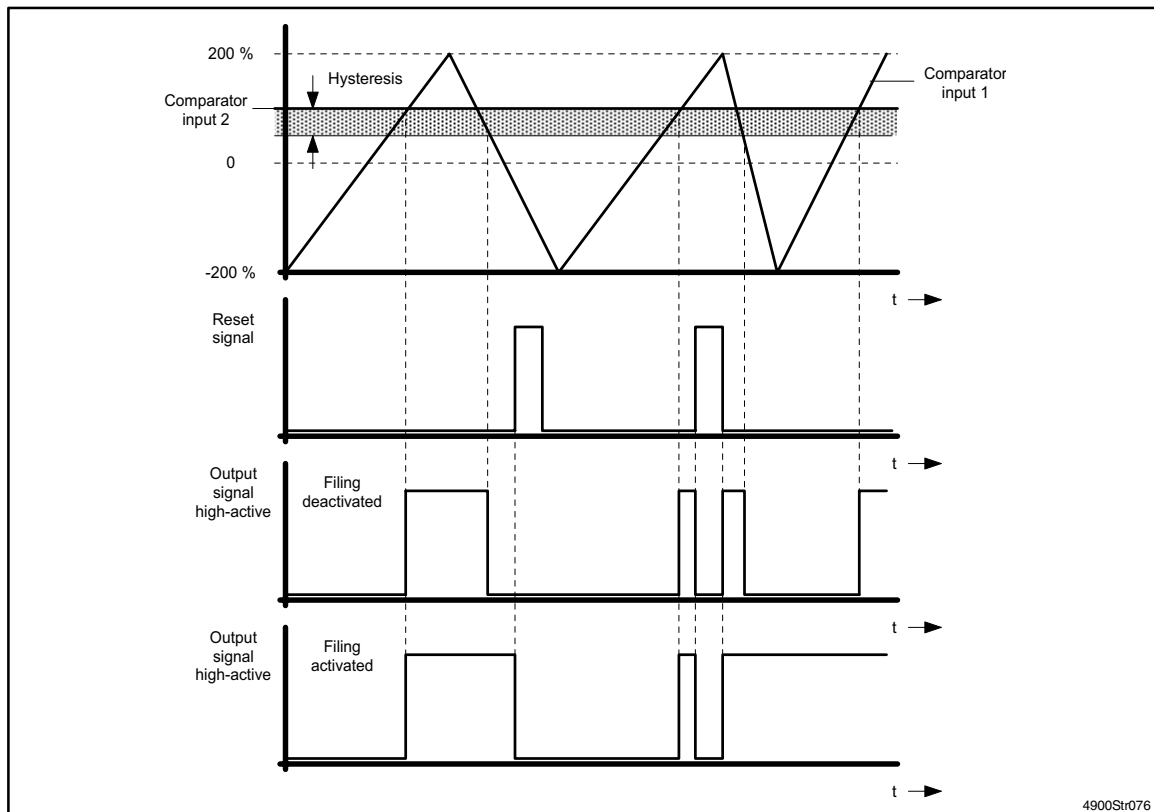
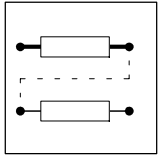

4900Str076

FIG 7-49 Output signal depending on the input signals of the freely assignable comparator

Under codes C582 and C592 the hysteresis can be changed with the range of 0...100 %. The hysteresis refers to the signal at input 2 of the comparator. If the lower threshold (value of the upper threshold according to input 2 minus value of the hysteresis) is $\leq -200\%$, the comparator output can be reset via the reset function.

If the memory function is activated under codes C583 and C593, the comparator sets the digital output when switching for the first time. The digital output can only be reset using the reset function.

For the time, the reset signal is active, the comparator resets the digital output independently of the memory function.

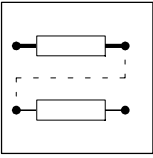

Configuration

Code	Name	Possible settings				Info
		Lenze	Selection			
C580*	Input 1, Comparator 1	0 %	-100.0 % -200 %	{0.1 %} {1 %}	+100.0 % +200 %	If an analog signal source (C145/C146) is assigned, the parameter will be displayed only.
C581*	Input 2, Limit value for comparator 1	0 %	-100.0 % -200 %	{0.1 %} {1 %}	+100.0 % +200 %	If an analog signal source (C145/C146) is assigned, the parameter will be displayed only.
C582*	Hysteresis for lower threshold Comparator 1	0 %	0 %	{0.1 %}	+100 %	Lower threshold = C581 - C582, reference: C581
C583*	Memory function Comparator 1		-0- Memory function not active The output is reset when the value falls below the lower threshold (C581 - C582) -1- Memory function active The output remains set after initial switch on.			
C584*	Reset function Comparator 1		-0- Reset function not active -1- Reset function active			The activation resets the output
C590*	Input 1, Comparator 2	0 %	-100.0 % -200 %	{0.1 %} {1 %}	+100.0 % +200 %	If an analog signal source (C145/C146) is assigned, the parameter will be displayed only.
C591*	Input 2, Limit value for comparator 2	0 %	-100.0 % -200 %	{0.1 %} {1 %}	+100.0 % +200 %	If an analog signal source (C145/C146) is assigned, the parameter will be displayed only.
C592*	Hysteresis for lower threshold Comparator 2	0 %	0 %	{0.1 %}	+100 %	Lower threshold = C591 - C592, reference: C591
C593*	Memory function Comparator 2		-0- Memory function not active The output is reset when the value falls below the lower threshold (C591 - C592) -1- Memory function active The output remains set after initial switch on.			
C594*	Reset function Comparator 2		-0- Reset function not active -1- Reset function active			The activation resets the output

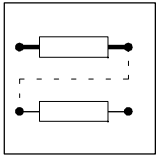

7.6 Additional control functions

7.6.1 Additional torque values



Stop!

The external torque limitation has an effect on the n controller input, not on the sum of torque set-value signals.

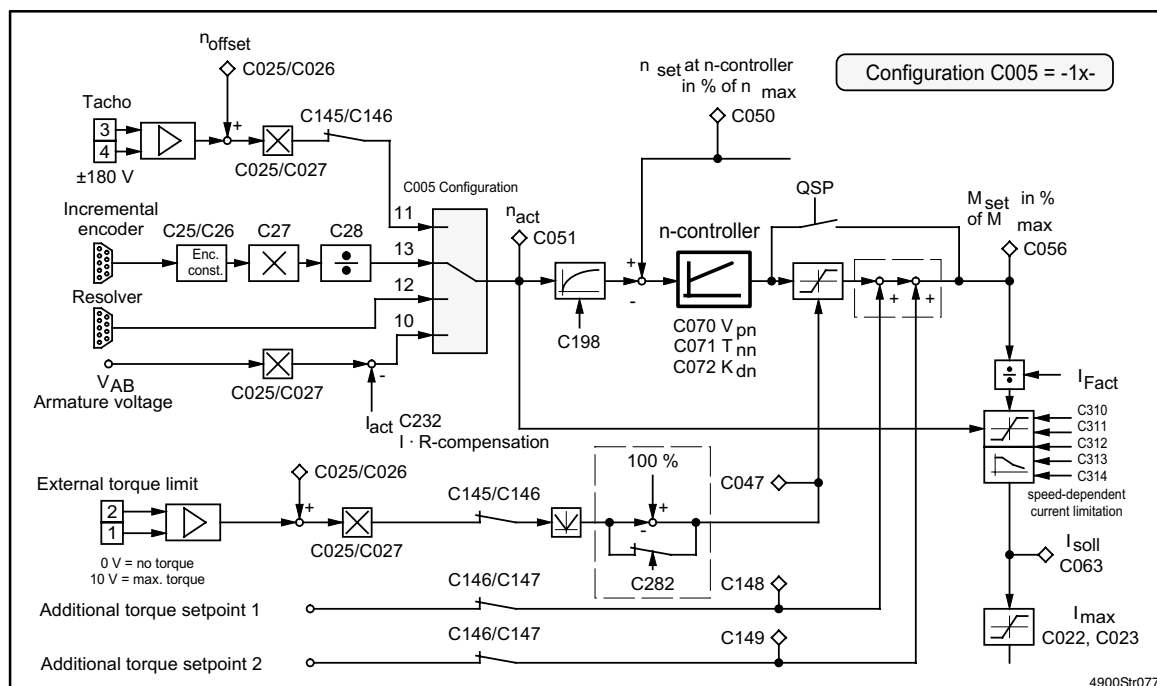

FIG 7-50 Signal-flow chart (section) for additional torque set-values

Purpose

The additional torque set-values can be used for friction compensation or acceleration (dv/dt)

Parameter setting

1. Input

With the function "freely assignable analog inputs" each input can be assigned to a "terminal signal" from the table in C145.

If signals are assigned to the inputs, the inputs codes are for display only. If the terminal control is deactivated, the actual terminal value will be accepted for operation.

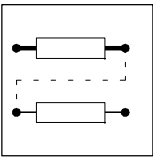

Configuration

If the inputs are not assigned, constant values can be assigned via the input codes. These values can also be stored in EEPROM via C003.

2. Function

The additional torque set-values have a summing influence on the n controller output. The sum of these signals is limited to 100%.

Code	Name	Possible settings		Info
		Lenze	Selection	
C148	Additional torque value 1	0	-100.0 % M_{max} {0.1 %} -200 % M_{max} {1%} +100.0 % M_{max} +200 % M_{max}	Display only with terminal control. If the terminal control is deactivated, the actual terminal value will be accepted for operation. In the armature setting range: 100 % M_{max} correspond to 100 % I_{max} (C022, C023)
C149	Additional torque value 2	0	-100.0 % M_{max} {0.1 %} -200 % M_{max} {1%} +100.0 % M_{max} +200 % M_{max}	Display only with terminal control. If the terminal control is deactivated, the actual terminal value will be accepted for operation. In the armature setting range: 100 % M_{max} correspond to 100 % I_{max} (C022/C023)

7.6.2 Speed dependent armature current limitation

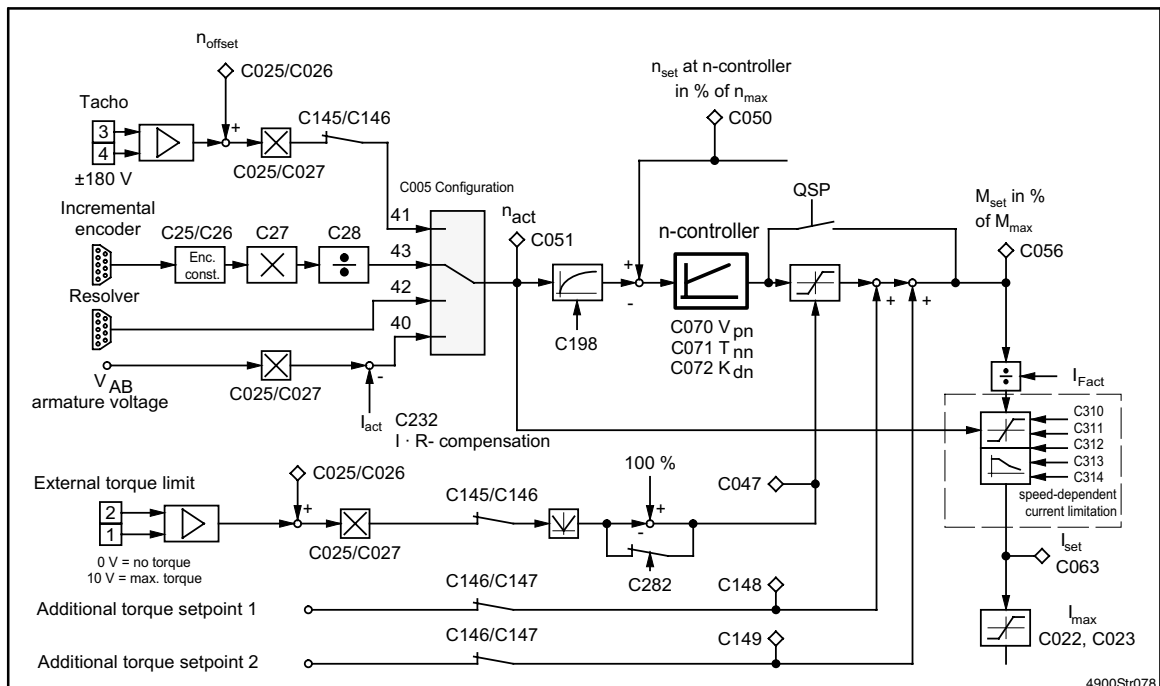
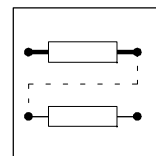

FIG 7-51 Signal-flow chart (section) for speed-dependent armature current limitation

Purpose

If DC machines are drive with rated armature current in field weakening operation, the segment voltage (at the armature) can reach impermissibly high values.



Therefore, the current limitation must be reduced depending on the compensation of the DC machine and the actual speed.

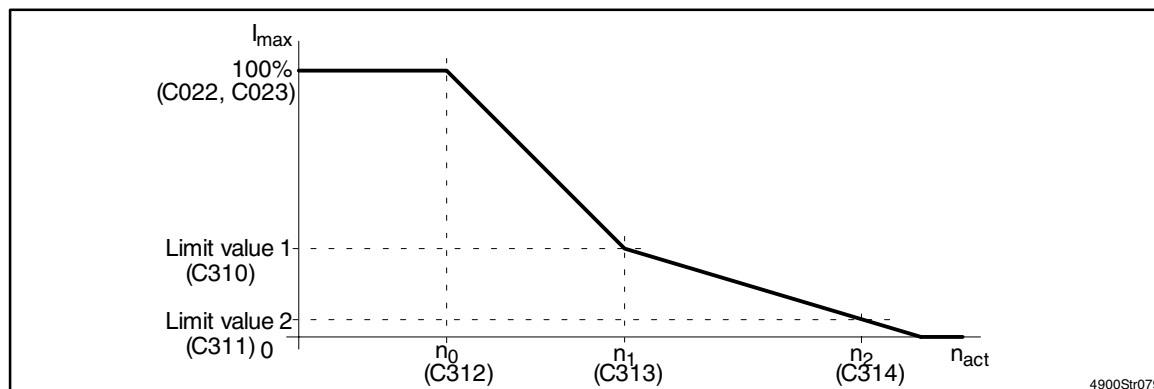

FIG 7-52 Parameter assignment to the speed-dependent armature current limitation

The speed-dependent current limitation acts on the current set-value C063 (reference I_{max} : C022, C023).

Linear characteristic

If the current limit is to be lowered linearly (depending on the machine used), the speed at which the reduction is to begin is set under C313. The slope of the characteristic is set under C311 and C314.

Non-linear characteristic

By means of a second section with linear slope, the non-linear characteristic can be approximated with two vertex.

The speed at which the lowering of the current limit is to start can be set with the parameter C312. The slope of the 1st section is set under codes C310 and C313. The 2nd section is parameterised with codes C311 and C314.

Motor types

Usually, compensated machines require a current reduction as of approx. 1:3 field weakening operation. Uncompensated machines require the reduction as of 1:1.2 field weakening operation. The current limitation is then to be lowered with the function $1/n$.

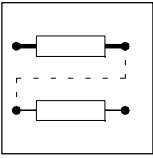

Configuration

Code	Name	Possible settings			Info
		Lenze	Selection		
C310*	Speed-dependent current limitation Limit value 1	100%	0.0 %	{0.1 %} +100.0 %	Valid for speed under C313 C310 must be higher than C311!
C311*	Speed-dependent current limitation Limit value 2	100%	0.0 %	{0.1 %} +100.0 %	Valid for speed under C314 C311 must be smaller than C310!
C312*	n0 Speed-dependent current limitation	3000 rpm	0 rpm	{1 rpm} 5000 rpm	Actual speed threshold (activation of current limitation), condition: $n_1 > n_0$
C313*	n1 Speed-dependent current limitation	4000 rpm	0 rpm	{1 rpm} 5000 rpm	Actual speed threshold for limit value 1, condition: $n_2 > n_1 > n_0$
C314*	n2 Speed-dependent current limitation	5000 rpm	0 rpm	{1 rpm} 5000 rpm	Actual speed threshold for limit value 2, condition: $n_2 > n_1 > n_0$

For more detailed information see the motor catalogue or contact the manufacturer.

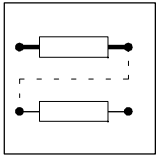

7.6.3 n controller adaptation

Purpose

The adaptation of the speed controller is to improve the control behaviour. It is recommended for

- low speed set-values (start)
- set-value jumps from $n_x \rightarrow 0$ (stop) without return and drives with high inertias.

Adaptation via characteristic

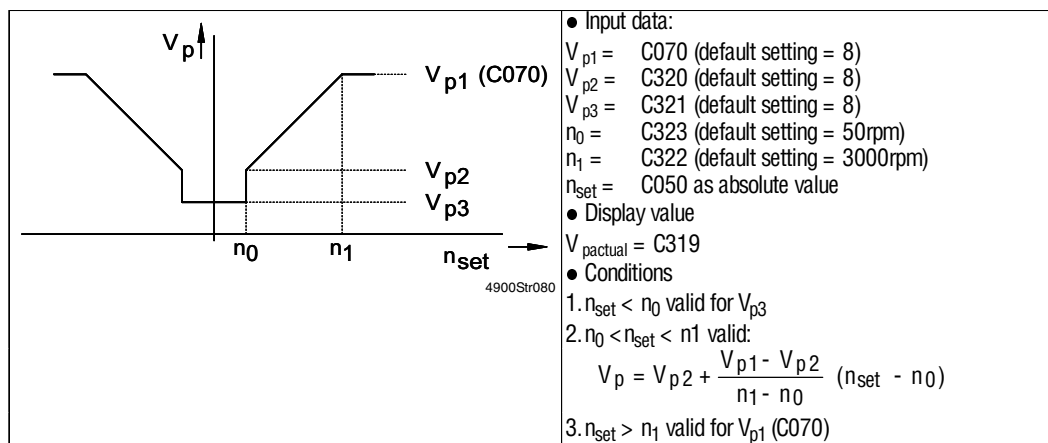

FIG 7-53 Characteristic for internally derived n controller adaptation

The n controller adaptation is enable under $C324 = -1-$. The input of the n controller adaptation must not be assigned with an analog signal (see C145 / C146).

Adaptation via analog input terminal

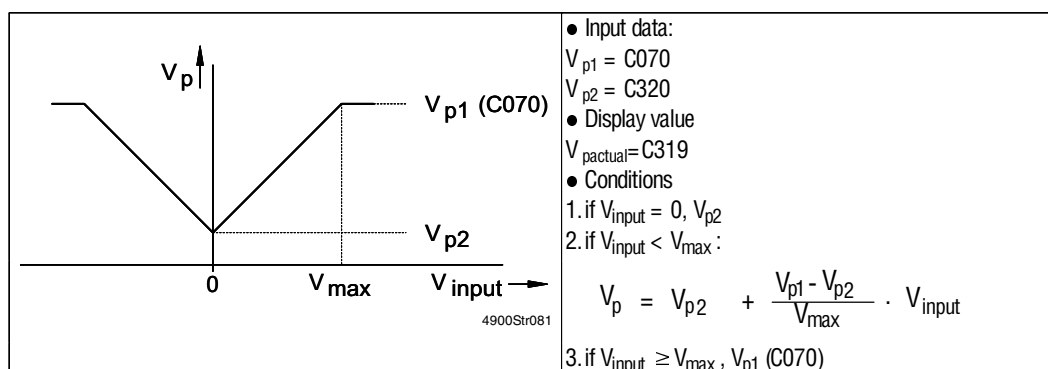
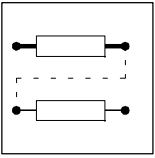

FIG 7-54 Characteristic for external selection of the n controller adaptation

The n controller adaptation is enable under $C324 = -1-$. The input of the n controller adaptation must be assigned to an analog signal using C145 / C146.



Configuration

7.6.4 S-shaped ramp function generator characteristic

For the ramp generator of the main set-value you can select two different characteristics under C134:

- linear characteristic for all accelerations which require a constant acceleration
- S-shaped characteristic for all accelerations which require a shock-free acceleration.

Code	Name	Possible settings				Info
		Lenze	Selection			
C012	Acceleration time T_{i_r} for main set-value	0.00s	0.00 s 1 s 10 s 100 s	{0.01 s} {0.1 s} {1 s} {10 s}	1 s 10 s 100 s 990 s	Time refers to $0...n_{max}$
C013	Deceleration time T_{i_r} for main set-value	0.00s	0.00 s 1 s 10 s 100 s	{0.01 s} {0.1 s} {1 s} {10 s}	1 s 10 s 100 s 990 s	Time refers to $0...n_{max}$
C131*	Ramp function generator STOP	0	-0- -1-	Enable ramp function generator Stop ramp function generator		If ramp function generator STOP (main setpoint) is enabled via terminal, C131 is for display only.
C132*	Ramp function generator input = 0	0	-0- -1-	Enable mains setpoint at RFG input Ramp function generator input = 0		
C134*	Ramp function generator characteristic	0	-0- -1-	Linear characteristic S-shaped characteristic		
C182*	T_i time of the s-shaped ramp function generator	20.0 s	0.01 s 1s 10s	{0.01 s} {0.1s} {1s}	1 s 10s 50s	T_i time for the S-shape ramp function generator of the main set-value

Depending on the operating mode, the functions RFG stop (C131) and ramp function generator input = 0 (C132) can be controlled and used for other switching via the keypad, LECOM interface or freely assignable digital input terminals.



Note!

With setting controller inhibit, the signal at the RFG output jumps to the value = 0. If the controller is enabled again, the set-value at the RFG output accelerates from the actual speed to the speed set-value.

7.6.5 Actual speed filter

The actual speed circuit is equipped with a PT1 filter which is activated under C198. The filter can be used to reduce mechanical resonances. The filter should only be used in configurations without superimposed phase control circuits. (C254=0).

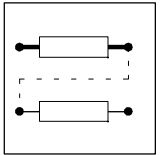

Code	Name	Possible settings			Info
		Lenze	Selection		
[C198*]	Enable actual speed filter	0	-0- Filter not active	-1- Filter active	
C199*	Time constant act. speed filter	10ms	8ms	{1ms} 100ms	



Stop!

Another time constant in the speed control circuit can lead to instability of the drive!

7.6.6 Excitation characteristic

In basic configuration, the DC controller uses an internally stored excitation characteristic to detect armature current set-values and to adapt the control parameters of the field current controller in field weakening operation. The influence of the internal excitation characteristic can be switched off via code C235. If this is the case, the further control process is based on operation with rated excitation (I_{rated}) i.e. neither the gain of the armature control circuit nor the adaptation of the control parameters for the field current controller are adjusted. The external selection of the excitation characteristic is possible by assigning an analog signal source using codes C145/C146.

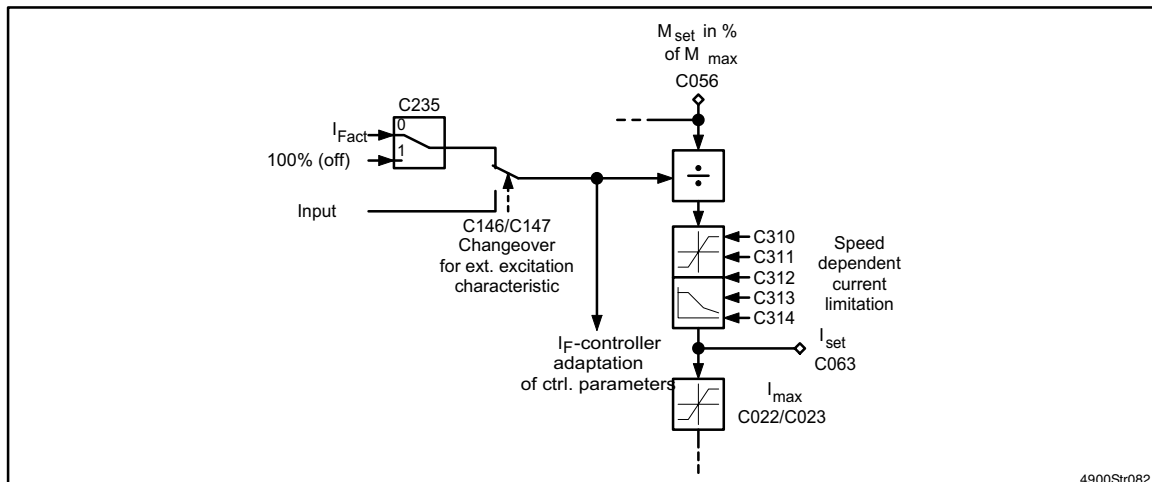
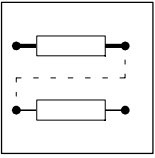

FIG 7-55 Signal-flow chart (section) for the selection of the excitation characteristic

Code	Name	Possible settings			Info
		Lenze	Selection		
[C235*]	Excitation characteristic	0	-0- internal excitation characteristic active	-1- internal excitation characteristic not active	With C235= -1-, the control process is based on operation with rated excitation.



Configuration

7.7 Monitoring



Note!

Fault messages can only be reset, when the fault has been eliminated.

7.7.1 Change of the monitoring functions

Purpose

The changeover offers the possibility to select whether the monitoring function is indicated as TRIP, warning, message with pulse inhibit or without pulse inhibit. Furthermore, monitoring functions can also be switched off.



Warning!

For safety reasons the drive should always be disconnected from the mains while trouble shooting mains failures or failures of the actual value encoder.

TRIP

In the event of a failure, the ignition pulses for armature circuit and field circuit are inhibited, the digital outputs TRIP and IMP are set and RDY is reset. The failure is automatically indicated under C067 and it is entered in the history buffer. The history buffer is not deleted when switching off the mains.

A TRIP must be reset after the fault has been eliminated.

Warning

In the event of a failure one of the freely assignable digital outputs is set (if the function "Warning" is assigned to the output). The warning is automatically indicated under C066 and it is entered in the history buffer. The history buffer is not deleted when switching off the mains.

A warning must be reset after the fault has been eliminated.



Stop!

If a controller protecting monitoring function ("It monitoring", overtemperature heat sink, overvoltage) is selected as warning, the controller can be destroyed if the fault is not eliminated in time.

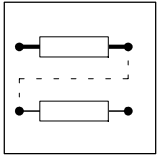

Message with pulse inhibit

In the event of a failure the ignition pulses are only inhibited for the armature circuit, the digital output IMP is set, and one of the freely assignable digital output is set (if the function "Message" is assigned to the output). The message is automatically indicated under C065 and it is entered in the history buffer. The history buffer is deleted when switching off the mains.

Message without pulse inhibit

In the event of a failure one of the freely assignable digital outputs is set (if the function "Message" is assigned to the output). The message is automatically indicated under C065 and it is entered in the history buffer. The history buffer is deleted when switching off the mains.

Name	Lecom No.	TRIP	Warning	Message with IMP	Message without IMP	can be switched off
OC5	15	1	X			
OC6	16	X	X			1
OUE	22	1	X			
LU1	31	1		X		X
LU	32	X		1		
LF	41	1		X		
OF	42	1		X		
OH	50	1	X			
CEO	61	1	X			X
U15	70	1	X			
CCr	71	X				
PR	72	X				
PR1	72	X				
PR2	72	X				
PR3	72	X				
PR4	72	X				
PER	73	X				
SP	80	1	X			X
Sd1	81	1	X			X
Sd2	82	1	X			X
Sd3	83	1	X			X
Sd4	84	1	X			X
Sd5	85	1	X			X
EEr	91	1	X	X	X	
dEr	93	1	X			X
ACI	94	1	X			X
FCI	96	1	X			X
P03	153	X	X	X	1	X
P13	163	1				X
CE9	69	X	X	X	X	1

X = Selection possible

- = Selection not possible

1 = Default setting

* Acknowledgement not possible during TRIP

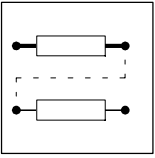

Configuration

Changeover of the monitoring function with active TRIP

Even if a monitoring function has activated a TRIP, which is still active, it can be changed to warning or message:

- The display changes to warning or message.
- The TRIP remains active!
- Acknowledge the TRIP after fault elimination:
 - under C067 with SH + PRG or
 - via terminal "TRIP reset"

Basic settings for some monitoring functions at configuration changeover

The monitoring function for 'defective analog encoder (Sd1), resolver fault (Sd2), encoder fault at X5 (Sd3) and encoder fault at X9 (Sd4) are preset when the configuration is changed (C005). The setting depends on the configuration.

Configuration	Sd1 Defective analog encoder	Sd2 Resolver fault	Sd3 Encoder fault at X5	Sd4 Encoder fault at X9
C005 = -10-	switched off	switched off	switched off	switched off
C005 = -11-	TRIP	switched off	switched off	switched off
C005 = -12-	switched off	TRIP	switched off	switched off
C005 = -13-	switched off	switched off	switched off	TRIP
C005 = -40-	switched off	switched off	switched off	switched off
C005 = -41-	TRIP	switched off	switched off	switched off
C005 = -42-	switched off	TRIP	switched off	switched off
C005 = -43-	switched off	switched off	switched off	TRIP
C005 = -52-	switched off	TRIP	switched off	switched off
C005 = -53-	switched off	switched off	TRIP	switched off
C005 = -62-	switched off	TRIP	switched off	switched off
C005 = -63-	switched off	switched off	TRIP	switched off
C005 = -72-	switched off	TRIP	switched off	switched off

These monitoring functions can be changed subsequently.

Display priority when different fault types occur

1. TRIP (C067)
2. Warning (C066)
3. Message with pulse inhibit (C065)
(Pulse inhibit is also activated when a warning is active)
4. Message without pulse inhibit (C065)

Independently of the priority, all faults are displayed in the corresponding codes and entered in the corresponding history buffer.

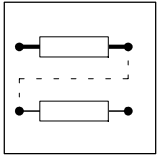

Code	Name	Possible settings		Info
		Lenze	Selection	
C119*	Selection of monitoring function		-15- OC5 -16- OC6 -22- OUE -31- LU1 -32- LU -41- LF -42- OF -50- OH -61- CEO -70- U15 -80- SP -81- Sd1 -82- Sd2 -83- Sd3 -84- Sd4 -85- Sd5 -91- EEr -93- dEr -94- ACI -96- FCI -153- P03 -163- P13 -69- CE9	I t overload (controller protection) I ² t overload (motor protection) Mains overvoltage Phase fault Mains undervoltage Mains underfrequency $f_{\text{mains}} < 47\text{Hz}$ Mains overfrequency $f_{\text{mains}} > 63\text{Hz}$ Overtemperature heat sink Communication error (automation interface) 15V failure Wrong signal source polarity Tacho short circuit/interruption Open circuit of resolver Encoder fault at X5 Encoder fault at X9 Defective setpoint encoder Ext. TRIP terminal Motor blocked Interruption of armature circuit Interruption of field circuit Following error Angle overflow Communication error (serial interface)
[C120*]	Change of monitoring function		-0- TRIP -1- Warning -2- Message with pulse inhibit -3- Message without pulse inhibit -4- Switched-off	The important monitoring functions are set according to the changes of the configuration under C005.



Stop!

With configurations C005 = -10- or -40- and in the event of encoder failure with redundant actual value feedback, the activation of the monitoring "Armature circuit interrupted" (ACI) cannot be guaranteed.

For separate electronics' supply, observe a special switch-off sequence. Otherwise, the monitorings "ACI" and "FCI" will be activated. Switch-off sequence:

- At first, inhibit the controller.
- Then disconnect field and armature from the mains.

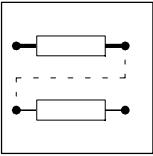

Configuration

7.7.2 Overload monitoring for the controller (I t monitoring)

The I t monitoring is designed for 150 % rated current.

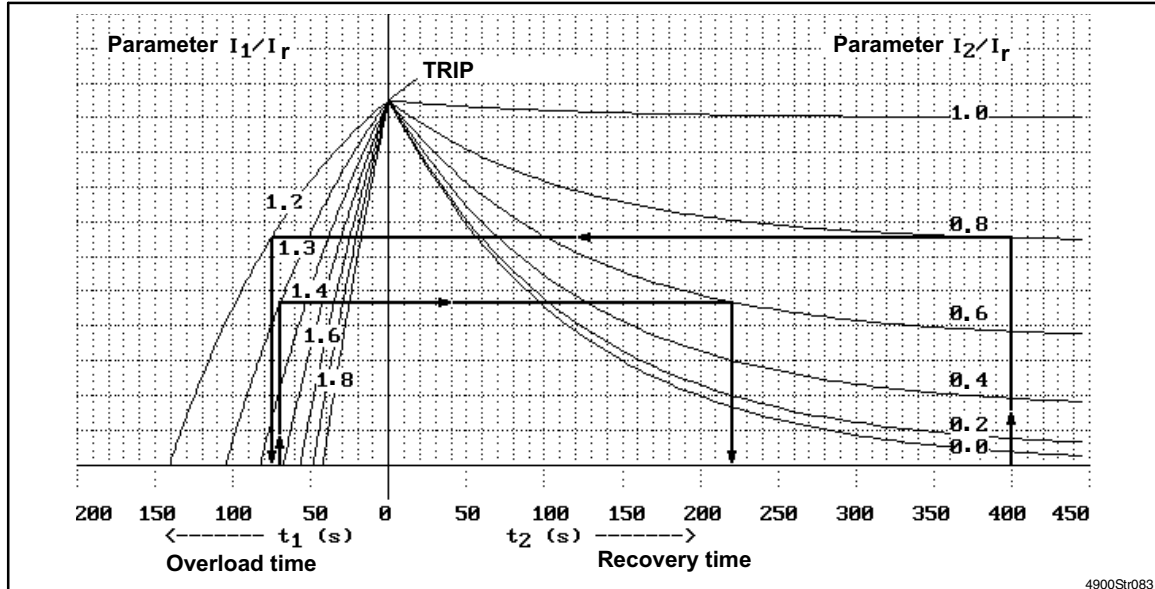

FIG 7-56 Overload diagram for 48XX/49XX controllers

The parameter I_1 / I_{rated} depends on the controller size. The ratio between maximum current and rated armature current is indicated in chapter 3.3.

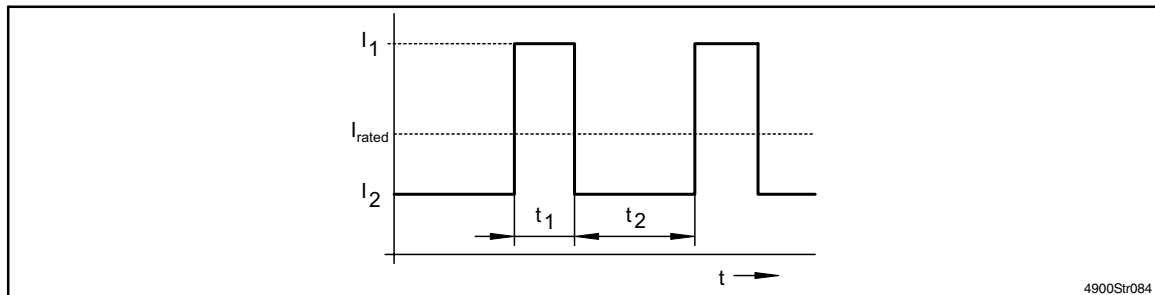
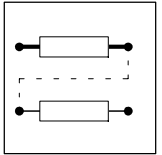

FIG 7-57 Possible current flow when using the full overload capacity of 48XX/49XX controllers

Examples for overload diagrams in FIG 7-56:

	given	required	Result from diagram
	Overload, $I_1 = 1.3 \cdot I_{rated}$ Overload time, $t_1 = 70s$	- $I_2 = ?$ (basic load) - $t_2 = ?$ (recovery time)	$I_2 = 0.6 \cdot I_{rated}$ $t_2 > 220 s$
2.	Basic load, $I_2 = 0.8 \cdot I_{rated}$ Recovery time $t_2 \geq 400s$	- $I_1 = ?$ (overload) - $t_1 = ?$ (overload time)	$I_1 = 1.2 \cdot I_{rated}$ $t_1 \leq 75s$

For safety reasons, the "I t monitoring" is rated for continuous load with rated armature current during mains switch-on.



7.7.3 Overload monitoring for the motor ($I^2 t$ monitoring)

The unit can approximately calculate and monitor the motor temperature. The calculation of the thermal characteristic is derived for externally ventilated motors.



Stop!

This monitoring does not provide full motor protection. The DC controller resets the calculated motor temperature by switching the mains. If the connected motor is already hot and still overloaded, overheating cannot be excluded. Self-ventilated motors cannot be protected with this monitoring.

For total motor protection, integrate a thermal contact or a PTC thermistor in the motor. Lenze DC motors are equipped with thermal contacts as standard.

The motor monitoring is set as follows:

1. Enter the thermal time constant under C085.
2. Enter the rated motor current under C088.
3. Select the " $I^2 t$ monitoring" under C119.
4. Activate the " $I^2 t$ monitoring" under C120.

If the motor current exceeds the limit for a long period of time, the fault message "OC6" occurs and the controller is inhibited.

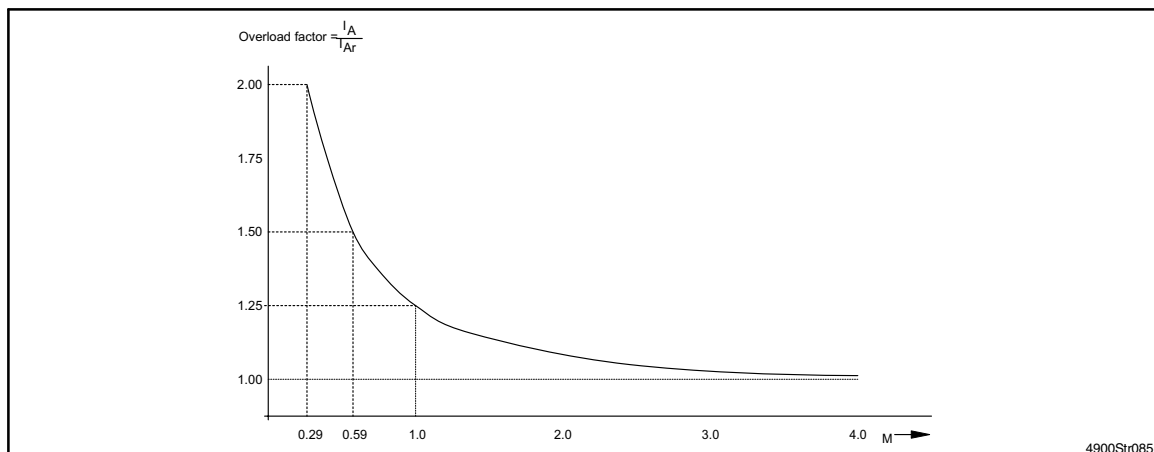
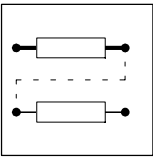
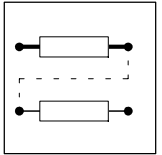

FIG 7-58 $I^2 t$ monitoring



Configuration

Code	Name	Possible settings			Info
		Lenze	Selection		
C085*	Thermal motor time constant	1.0 min	1.0 min	{0.1 min} 100.0 min	Required for "I ² t monitoring" (motor protection)
C088	Rated motor current		0 A 100 A	{0.1A} 100 A {1A} 3600 A	Rated current depends on the controller: 0..87A (4902) 0..135A (4903) 0..270A (4904) 0..450A (4905) 0..720A (4906) 0..900A (4907) 0..1200A (4X08) 0..1800A (4X09) 0..2520A (4X11) 0..3600A (4X12) See motor nameplate
C119*	Selection of monitoring function		-15- OC5 -16- OC6 -22- OUE -31- LU1 -32- LU -41- LF -42- OF -50- OH -61- CEO -70- U15 -80- SP -81- Sd1 -82- Sd2 -83- Sd3 -84- Sd4 -85- Sd5 -91- EEr -93- dEr -94- ACI -96- FCI -153- P03 -163- P13 -69- CE9		I t overload (controller protection) I ² t overload (motor protection) Mains overvoltage Phase fault Mains undervoltage Mains underfrequency f _{Mains} < 47Hz Mains overfrequency f _{Mains} > 63Hz Overtemperature heat sink Communication error (automation interface) 15V failure Wrong signal source polarity Tacho short circuit/interruption Open circuit of resolver Encoder fault at X5 Encoder fault at X9 Defective setpoint encoder Ext. TRIP terminal Motor blocked Interruption of armature circuit Interruption of field circuit Following error Angle overflow Communication error (serial interface)
[C120*]	Change of monitoring function		-0- TRIP -1- Warning -2- Message with pulse inhibit -3- Message without pulse inhibit -4- Switched-off		The important monitoring functions are set according to the changes of the configuration under C005.



7.7.4 Blocking protection for the motor

Purpose

The blocking protection avoids that the collector of the DC motor is overheated in standstill.

Function

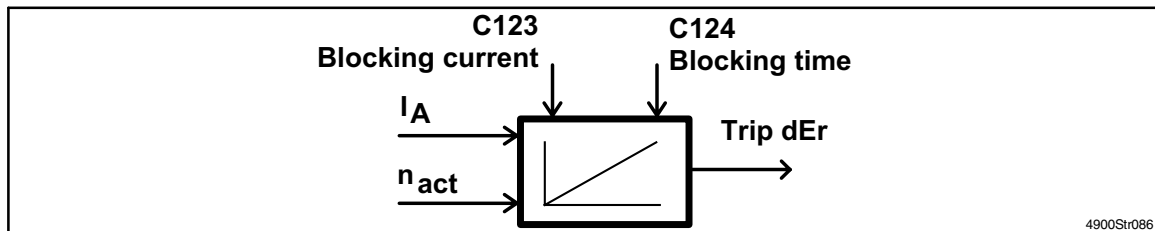
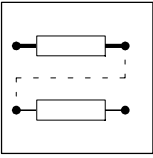

FIG 7-59 Blocking protection function

The blocking protection is activated if

- $I_{A_{act}} > \text{threshold in C123}$
- $n_{act} < 1\% n_{rated}$ (C087) and
- the blocking time set (C124) are exceeded.



Configuration

Code	Name	Possible settings			Info	
		Lenze	Selection			
C119*	Selection of monitoring function		-15- -16- -22- -31- -32- -41- -42- -50- -61- -70- -80- -81- -82- -83- -84- -85- -91- -93- -94- -96- -153- -163- -69-	OC5 OC6 OUE LU1 LU LF OF OH CEO U15 SP Sd1 Sd2 Sd3 Sd4 Sd5 EEr dEr ACI FCI P03 P13 CE9		I t overload (controller protection) I ² t overload (motor protection) Mains overvoltage Phase fault Mains undervoltage Mains underfrequency $f_{\text{Mains}} < 47\text{Hz}$ Mains overfrequency $f_{\text{Mains}} > 63\text{Hz}$ Overtemperature heat sink Communication error (automation interface) 15V failure Wrong signal source polarity Tacho short circuit/interruption Open circuit of resolver Encoder fault at X5 Encoder fault at X9 Defective setpoint encoder Ext. TRIP terminal Motor blocked Interruption of armature circuit Interruption of field circuit Following error Angle overflow Communication error (serial interface)
[C120*]	Change of monitoring function		-0- -1- -2- -3- -4-	TRIP Warning Message with pulse inhibit Message without pulse inhibit Switched-off		The important monitoring functions are set according to the change of configuration under C005.
C123	Current threshold for blocking protection for C124	0.95 I_{rated}	0 A 100 A	{0.1A} {1 A}	100 A 3600 A	Rated current depends on the controller: 0 ... 87A (4902) 0 ... 135A (4903) 0 ... 270A (4904) 0 ... 450A (4905) 0 ... 720A (4906) 0 ... 900A (4907) 0 ... 1200A (4X08) 0 ... 1800A (4X09) 0 ... 2520A (4X11) 0 ... 3600A (4X12) 0 ... 4050A (4X13) See motor nameplate
C124*	Blocking time	60 s	1 s	{1 s}	100 s	Motor standstill time until fault message is activated

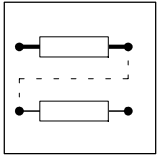

7.7.5 Mains monitoring

Purpose

The monitoring ensure faultfree mains operation. In the event of mains failures it is not possible to refer to the actual mains status. Therefore, the controller sets pulse inhibit and activates the monitoring function prioritized accordingly.

Message	Fault	Cause
LU1	Phase failure	Failure of the mains voltage or mains interruption for more than 120 ms If the mains interruption is shorter than 120 ms (e.g. if the short-circuit power of the mains is too low for the DC controller), only pulse inhibit will be set.
LU	Mains undervoltage	Mains voltage < 340V or < 410V (variant V014)
OE	Mains overvoltage	Mains voltage > 460V or > 550V (variant V014)
LF	Mains underfrequency	Mains frequency < 47Hz
OF	Mains overfrequency	Mains frequency > 63Hz



Caution!

If one of the mains monitorings is activated, the drive torque can be lost.

Mains synchronisation for DC controllers

In practice, two complete different mains conditions for DC controller operation must be considered.

1. Powerful interconnected system which is characterised by a low internal resistance:
The frequency of the mains voltage is more or less constant. The sine wave is distorted.
Phase failures - static and short-term - are possible.
2. Isolated operation, characterised by a small ratio of generator power and DC controller power:
The mains voltage amplitude and frequency fluctuations can be caused by loads. Under load, the wave considerably differs from the sine wave.
Phase failures - static and short-term - are possible.

Under C237 the synchronisation can be adapted to the existing mains situation.

C237 = 0 The synchronisation is carried out as in the software versions up to V5.2 (see code C099).

In the event of mains failures, the synchronisation procedure sets pulse inhibit itself. By this, blown fuses can be avoided in the extent possible with physical measures. Precondition for fault-free operation with this operating mode is that the mains supply corresponds to the VDE 0160 which contains regulations for DC controller operation.

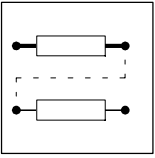

Configuration

C237 = 1

Short synchronisation fault do not result in pulse inhibit. This procedure should be used under the conditions listed under point 2.

C237 = 2

In the event of mains failures, the synchronisation procedure sets pulse inhibit itself. Frequency fluctuations are processed slowly. By this, blown fuses can be avoided in the extent possible with physical measures. Only to be used with mains with fixed frequencies, as described under point 1.

C237 = 3

Short synchronisation faults do not result in pulse inhibit. Only to be used with mains with fixed frequencies, as described under point 1.

Changeover only when the controller is inhibited.

Code	Name	Possible settings		
		Lenze	Selection	Info
[C237*]	Synchronisation mode	0	-0- dyn. IMP, 20 ms correction -1- no dyn. IMP, 20 ms correction -2- dyn. IMP, 400 ms correction -3- no dyn. IMP, 400 ms correction	

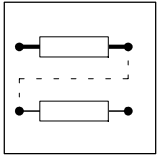

7.7.6 Monitoring of the serial interface

The controller detects an interruption because incoming telegrams are not received.

- The monitoring is activated under C119 = -69- with C120 (default setting = switched off).
- Reactions allowed are trip, warning, message and switched off.
- The time between cancelling the communication and activation of the monitoring function is to be set under C126.

Code	Name	Possible settings				Info
		Lenze	Selection			
C126*	Time delay (monitoring serial interface)	3000 s	0.2 s	{0.1 s}	10 s	
			10 s	{1 s}	100 s	
			100 s	{10 s}	3600 s	



Note!

If a new parameter set is loaded, the time until the monitoring function is activated starts again. The monitoring works independently of the RDY message.

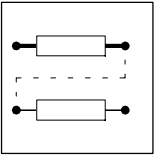

7.8 Parameter setting

- With the parameter setting of the controller you can adapt the drive to your application.
- The complete parameter set is organized in codes which are consecutively numbered and start with "C" (chapter 7.9).
- It is possible to save the parameter set for an application.
 - Four parameter sets are available, so that the controller can be easily switched from one application to another.
 - The parameter sets 1, 3 and 4 are factory set when delivered. Parameter set 2 is set for an unwinder with diameter precontrol.

7.8.1 Ways of parameter setting

- It is possible to select a code, to change the parameters and transfer the changes to the controller, via
 - the operating unit of the controller
 - LECOM interfaces

These Operating Instructions only describe the change of parameters via the operating unit.

The description of parameter setting via LECOM interfaces or fieldbus systems can be obtained from the corresponding Operating Instructions.

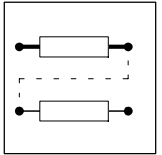

7.8.2 Functions of the operation unit

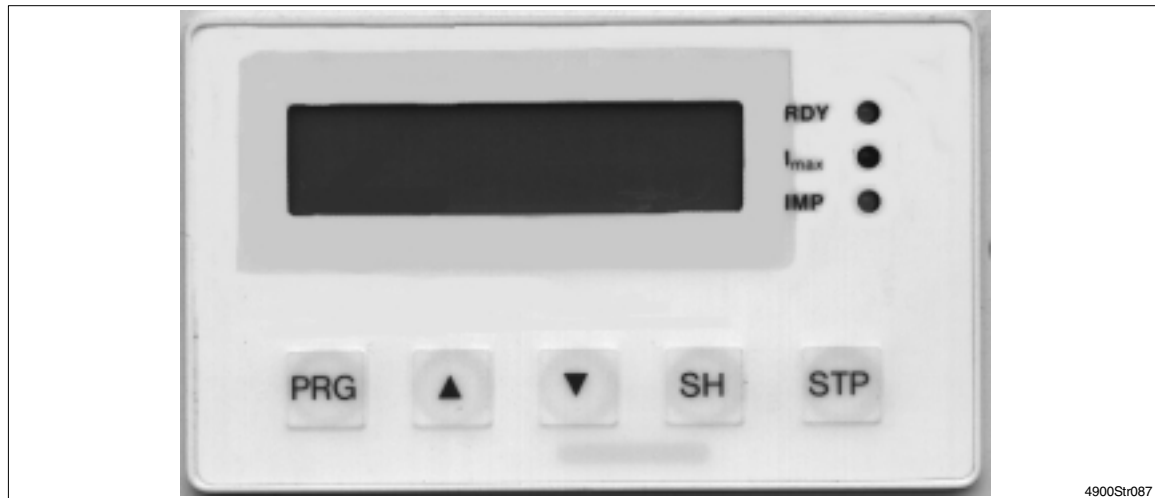

FIG 7-60 Front view: Operating unit with status display

LED	Colour	Function
RDY	green	Ready for operation not on in the event of TRIP
I _{max}	red	on, if the speed controller operates at current limit
IMP	yellow	Pulse inhibit on, if the controller is inhibited or message LU is displayed

Bedientaste	Key function
PRG	Change between code and parameter level
SH+ PRG	Accept change
▲	Increase displayed value
SH+ ▲	Increase displayed value fast
▼	Decrease displayed value
SH+ ▼	Decrease displayed value fast
STP	Inhibit controller
SH+ STP	Enable controller



Note!

- 'SH +'
 - Press and hold key SH.
 - Press second key indicated.
- Display
 - The position of the arrow " " indicates the current operating level (code or parameter level).

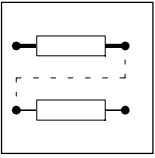

Configuration

7.8.3 Structure of the operating programme

The parameters are set in two operating levels – the code level and the parameter level. The symbol "→" in the display marks the active operating level:

1. In the code level select a code with ▼ or ▲ .
2. Change to the parameter level by pressing the key PRG.
3. Parameters are changed with ▼ or ▲ .
After acceptance, the operating program leads you back to the code level (chapter 7.8.4.1).
4. With parameters with a high resolution (e. g. C032, C033, ...), the values to be changed can be directly determined. When being in the parameter level, press the "SH" key and tip on ▲ . The cursor will move to the left to higher values. Press the "SH" key and ▼ to move the cursor to lower values.

Code level

The whole code set of the controller is subdivided into standard codes and extended codes:

Extended code set	
Standard code set (factory setting): Codes for most frequently used applications	Additional codes: Codes for special applications

With C000 = -2- you change from the standard code set to the extended code set by pressing SH + PRG.

Parameter level

- Each code provides parameters for drive adjustment or reading out the operating status.
- There are four different parameter types:
 - absolute values of a physical variable (e. g. 400 V, 10 s)
 - relative values of controller variables (e. g. 50% setpoint)
 - numbers for certain states
(e. g. -0- = controller inhibited, -1- = controller enabled).
 - Display values
These values can only be displayed but not changed
(e. g. C054 actual motor current)
- Absolute and relative values can be modified in discrete steps. The steps can change in the parameter-setting range.
 - Example acceleration time T_{ir} (C012):
 - 3 steps in the whole parameter-setting range
 - T_{ir} of 0.01 s - 1 s Step 0.01 s
 - T_{ir} of 1 s - 10 s Step 0.1 s
 - T_{ir} of 10 s - 100 s Step 1 s

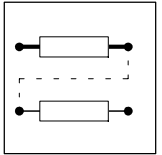

7.8.4 Basics for operation

7.8.4.1 Parameter change via a code



Note!

If changed parameter sets are required after mains switching, they must be stored (chapter 7.8.4.3).

Each code with parameters, which can be changed, is factory set. Depending on the code there are three possibilities to change a parameter.

Each possibilities is explained by means of an example.

Direct acceptance (on-line)

The controller accepts the changed parameter immediately.

1. Select a code using ▲ or ▼ .
2. Change to the parameter level using PRG.
3. Select a parameter using ▲ or ▼ .
The controller accepts the changed parameter immediately.
This is also possible during operation of the drive.
4. Change to the code level using PRG.

Code level

Code	Parameter	Unit
→ C 0 1 1	3 0 0 0	r p m
N m a x	S P E E D	

PRG →

Parameter level

Code	Parameter	Unit
C 0 1 1	→ 3 0 0 0	r p m
N m a x	S P E E D	

Change a parameter with ▲ or ▼ ↓

Code	Parameter	Unit
→ C 0 1 1	2 7 5 0	r p m
N m a x	S P E E D	

PRG ←

Code	Parameter	Unit
C 0 1 1	→ 2 7 5 0	r p m
N m a x	S P E E D	

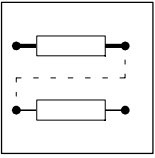

Configuration

Acceptance with SH + PRG

The controller accepts the changed parameter only after pressing SH+PRG.

1. Select a code using ▲ or ▼.
2. Change to the parameter level using PRG.
3. Change a parameter (even while the drive is running) using ▲ or ▼.
4. Press SH + PRG. (--ok-- is displayed for approx. 0.5 s)
The controller now works with the new parameter.

Code level

Code	Parameter	Unit
→ C 0 8 3	0 . 0 0	A
F I E L D	C U R R E N T	

PRG
→

Parameter level

Code	Parameter	Unit
C 0 8 3	→ 0 . 0 0	A
F I E L D	C U R R E N T	

Change a parameter
with ▲ or ▼



Code	Parameter	Unit
→ C 0 8 3	1 . 2 0	A
F I E L D	C U R R E N T	

SH + PRG
←

Code	Parameter	Unit
C 0 8 3	→ 1 . 2 0	A
F I E L D	C U R R E N T	

Acceptance with SH + PRG when the controller is inhibited

The controller only accepts the changed parameter when the controller is inhibited and after pressing SH + PRG.

1. Select a code using ▲ or ▼
2. Change to the parameter level using PRG.
3. Change a parameter (even if the drive is running) using ▲ or ▼ .
4. Press STP to inhibit the controller.
5. Press SH + PRG. (--ok-- is displayed for approx. 0.5 s)
6. Press SH + STP to enable the controller again
The controller now works with the new parameter.

Code level

Code	Parameter	Unit
→ C 0 0 5	- 1 1 -	
C o n f i g u r a t i o n		

PRG
→

Parameter level

Code	Parameter	Unit
C 0 0 5	→ - 1 1 -	
S P E E D	C T R L T A C H O	

Change a parameter
with ▲ or ▼



Code	Parameter	Unit
→ C 0 0 5	- 1 0 -	
C o n f i g u r a t i o n		

STP
2. SH + PRG
←

Code	Parameter	Unit
C 0 0 5	→ - 1 0 -	
S P E E D	C T R L A R M A T	

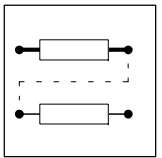

7.8.4.2 Parameter change via two codes

Some settings are parameterised via two codes:

1. Select the parameter to be changed with the input selection
2. Change the parameter in the setting code.

Selection code		for parameter input under	
C025	Encoder	C026	Encoder constant
		C027	Encoder adjustment (factor)
		C028	Encoder adjustment (divisor)
		C029	Automatic adjustment
C038	JOG setpoint selection	C039	JOG setpoint
C100	Additional acceleration and deceleration time	C101	Acceleration time
		C103	Deceleration time
C110	Monitor output	C111	Monitor signal
		C108	Gain
		C109	Offset
C112	Selection of freely assignable digital inputs	C113	Function of the digital terminal
		C114	Polarity
		C115	Function priority
C116	Selection of freely assignable digital outputs	C117	Function of the digital terminal
		C118	Polarity
		C128	Delay time
C145	Selection of freely assignable analog inputs	C146	Signal input
		C147	Priority
C192	Selection of freely assignable fixed setpoints	C193	Fixed setpoints

Example “Automatic tacho adjustment”

Code level

Code	Parameter	Unit
→ C 0 2 5	- 1 -	
E N C O D E R		

Code	Parameter	Unit
→ C 0 2 5	- 2 -	
E N C O D E R		

Select a code with s or t

Code	Parameter	Unit
→ C 0 2 9	X X X X	r p m
A U T O M .	E N C .	A D J .

Code	Parameter	Unit
→ C 0 2 9	Y Y Y Y	r p m
A U T O M .	E N C .	A D J .

Parameter changed

Parameter level

Code	Parameter	Unit
C 0 2 5	- 1 -	
T E R M I N A L S	1 , 2	

Change a parameter with ▲ or ▼

Code	Parameter	Unit
C 0 2 5	- 2 -	
T E R M I N A L S	3 , 4	

Code	Parameter	Unit
C 0 2 5	Y Y Y Y	r p m
A U T O M .	E N C .	A D J .

Change a parameter with ▲ or ▼

Code	Parameter	Unit
C 0 2 9	Y Y Y Y	r p m
A U T O M .	E N C .	A D J .

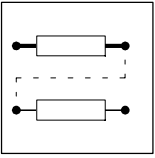

Configuration

7.8.4.3 Store parameter set

(see chapter 7.4.2)

The parameter must be stored to ensure that the setting will not be lost after mains switching.

Up to four different parameter sets can be created, if, for instance, a machine processes different materials or operates in different states (set-up, stand by, etc.).

If only one parameter set is required, store the change permanently under parameter set 1, because this parameter set is automatically loaded after switch on.

1. Select C003 using ▲ or ▼ .
2. Change to the parameter level using PRG.
3. Set the parameter to -1- using ▲ or ▼ .
This is also possible during operation of the drive.
4. Press SH + PRG.
--ok-- is displayed for approx. 0.5 s.
Your settings are permanently stored under "parameter set 1".

7.8.4.4 Load parameter set

(see chapter 7.4.2)

Loading is only possible when the controller is inhibited.



Warning!

With the loading a new parameter set, the controller is initialised and operates as if the mains had been switched.

User terminal X2/28 as source for the controller inhibit. Otherwise, the drive can start in an uncontrolled way when changing to another parameter set.

Main connection

The controller automatically loads parameter set 1.

Via keypad

1. Inhibit the controller via terminal 28.
2. Change to the parameter level using PRG.
3. Select C002 using ▲ or ▼ .
4. Select a parameter set using ▲ or ▼ .
5. Acknowledge with SH + PRG (--ok-- is displayed for approx. 0.5 s).
The parameter set selected is loaded. Enable the controller again.

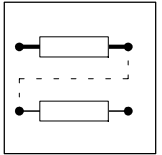

Via terminal control

With terminal control it is possible to change to other parameter sets via the digital inputs.

- Assign "select parameter set" to one or two digital input of each parameter set and "load parameter set" to one dig. input.
- The assignment of the digital inputs must be the same for all parameter sets used.
- The controller reads the terminals assigned with "select parameter set" as binary code. The input with the lower number is the first input, the input with the next higher number is the seconde input (e.g. E1 = 1st input, E2 = 2nd input). .

	1. input	2. input
Parameter set 1	0	0
Parameter set 2	1	0
Parameter set 3	0	1
Parameter set 4	1	1

The input with the function "load parameter set" is signal triggered. Length of the HIGH pulse: 10 ms...2 s.

1. Address digital inputs assigned to the function "select parameter set".
2. Inhibit controller with a LOW signal at terminal 28.
3. Supply a HIGH pulse to the digital input assigned to the function "load parameter set".
4. After loading, C002 indicates the number of the loaded parameter set.
5. Enable controller.



Note!

The RDY message is not indicated for the time the controller needs to select a new parameter set and can thus not respond to new input signals (LED and terminal 44).

7.8.4.5 Password protection

Use a password (three digit number) to protect your parameter settings from undenied access. If the password is not entered, the parameter of the standard code set can only be read but not changed. The parameter of the extended code set can neither be read nor changed:

1. Enter the password under C094.
2. Set C000 to -0- ("Standard code - read only").
Code C000 can only be changed after input of the password.

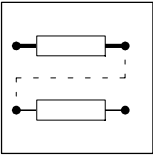

Configuration

7.8.5 Operating modes

The controller can be adapted to your application in different ways:

Terminals: The terminals are to control the controller.

Operating unit: There are five keys and the plain text display on the operating unit for parameter setting and control of the controller.

LECOM1: LECOM1 is a protocol for control and parameter setting of the unit via a PC or other hosts. The signals are processed to the interface standards RS232C and RS485. The controller can be connected to a superimposed system via X6.

LECOM2: For very difficult requirements, the controller can be parameter-set and operated with LECOM2 via fieldbus connection modules for standard bus systems (InterBus-S, PROFIBUS etc.).

Code	Name	Possible settings		Info																											
		Lenze	Selection																												
C001	Operating mode	0	<table border="0"> <tr> <td></td> <td>Control</td> <td>Parameter setting</td> </tr> <tr> <td>-0-</td> <td>Terminals</td> <td>Keypad</td> </tr> <tr> <td>-1-</td> <td>Keypad</td> <td>Keypad</td> </tr> <tr> <td>-2-</td> <td>Terminals</td> <td>LECOM1</td> </tr> <tr> <td>-3-</td> <td>LECOM1</td> <td>LECOM1</td> </tr> <tr> <td>-4-</td> <td>Terminals</td> <td>LECOM2 (*)</td> </tr> <tr> <td>-5-</td> <td>LECOM2 (*)</td> <td>LECOM2 (*)</td> </tr> <tr> <td>-6-</td> <td>LECOM2 (*)</td> <td>Keypad</td> </tr> <tr> <td>-7-</td> <td>LECOM2 (*)</td> <td>LECOM1</td> </tr> </table>		Control	Parameter setting	-0-	Terminals	Keypad	-1-	Keypad	Keypad	-2-	Terminals	LECOM1	-3-	LECOM1	LECOM1	-4-	Terminals	LECOM2 (*)	-5-	LECOM2 (*)	LECOM2 (*)	-6-	LECOM2 (*)	Keypad	-7-	LECOM2 (*)	LECOM1	<p>With C001 = -2-, -3-, -4-, -5-, -7-, TRIP must be reset (C043) via the interface or the terminal. With LECOM2, TRIP reset is also possible via the control word of the process data channel.</p> <p>(*) Fieldbus</p>
	Control	Parameter setting																													
-0-	Terminals	Keypad																													
-1-	Keypad	Keypad																													
-2-	Terminals	LECOM1																													
-3-	LECOM1	LECOM1																													
-4-	Terminals	LECOM2 (*)																													
-5-	LECOM2 (*)	LECOM2 (*)																													
-6-	LECOM2 (*)	Keypad																													
-7-	LECOM2 (*)	LECOM1																													



Note!

With control via keypad, LECOM1 and LECOM2, the terminal functions controller enable (X1/28), quick stop (X1/21 and X1/22) and the additional setpoint (X1/6) remain the same in the configurations C005 = -1X-, -4X-, -5X-.

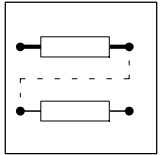

7.8.6 Display functions

Code set

The factory setting is the display of the standard code set.

The extended code set is displayed when selecting C000 = -2-.

Code	Name	Possible settings			Info
		Lenze	Selection		
C000	Code set	1	-0- (+ PW) Standard code set read only -1- (+ PW) Standard code set -2- (+ PW) Extended code set -9- For service only -11- Code set automation module		Can only be changed via keypad! If a password is defined under C094, a change from -0- to -1- or -2- is only possible after entering this password (+ PW): 1. Change C000, acknowledge with SH + PRG . 2. Password setting with ▲ or ▼ . 3. Accept with SH + PRG.
C094*	User password	0	0 {1} 999		0 = No password protection (see also C000)

Language

Code	Name	Possible settings			Info
		Lenze	Selection		
C098	Language	0	-0- German -1- English -2- French		

Actual value displays

Code	Name	Possible settings			Info
		Lenze	Selection		
C051	n_{act} speed		-5000 rpm {1 rpm} +5000 rpm		Display: actual speed
C052*	Motor voltage		0 V {1 V} 600 V		Display: motor voltage V_A
C054	Motor current		0.0 A 0.1 A} 100 A 100 A {1 A} 2000 A		Display: motor current I_A
C056	Torque setpoint		-100.0 % M_{max} {0.1 %} +100.0 % M_{max}		Display: Torque setpoint Armature setting range: 100% M_{max} correspond to 100% I_{max} (C022, C023)
C060*	Rotor position		0...2047		Display: absolute rotor angle position, standardized to 2048 incr./rev. Incremental encoder feedback: display only after zero track pulse.
C061*	I t load		0.0 % {0.1 %} 105.0%		Display: "I t load". Starting value when switching on the mains is always 100 % !
C185	P_{motor}		-500.0 kW {0.1 kW} 500.0 kW		Display: actual motor power
C186	M_{motor}		-999 Nm {1 Nm} 999 Nm		Display: actual motor torque
C187	I_{Fset}		0.00 A {0.01 A} 50.0 A		Display: actual field current setpoint
C188	I_{Fact}		0.00 A {0.01 A} 50.0 A		Display: actual field current value
C189	f_{mains}		0.0 Hz {0.1 Hz} 100.0 Hz		Display: actual mains frequency

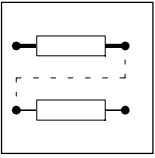

Configuration

Switch-on display

After switching on the controller, C083 is displayed first (field current). To change the switch-on display, enter the required code number under C004.

Code	Name	Possible settings			Info
		Lenze	Selection		
C004	Switch-on display	83	0 {1} 999		Code No. for switch-on display: Can only be changed if C001= -0-, -1-, -6-

Identification

The controller type is indicated under C093.

Code C099 indicates the software version used.

Code	Name	Possible settings			Info
		Lenze	Selection		
C093*	Device identification		49XX		Display: controller type
C099*	Software versions		49 6.X		Display: Series and software version

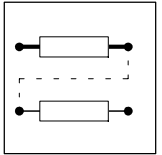

7.9 Code table

How to read the code table:

Column	Abbreviation	Meaning
Code	C013	Code C013
		<ul style="list-style-type: none"> The parameter value is accepted immediately (ONLINE).
	C009*	<ul style="list-style-type: none"> Code of the extended code set
	C001	<ul style="list-style-type: none"> The parameter value of the code will be accepted after pressing SH+ PRG.
	[C002]	<ul style="list-style-type: none"> The parameter value of the code will be accepted after pressing SH+ PRG, but only if the controller is inhibited.
Name		Name of the code
Lenze		Factory setting of the code
Selection	1 {1 %} 99	Minimum value {smallest step/unit} maximum value
Info	-	Additional, important explanation of the code

Code	Name	Possible settings																				
		Lenze	Selection	Info																		
C000	Code set	1	-0- (+ PW) Standard code set read only -1- (+ PW) Standard code set -2- (+ PW) Extended code set -9- For service only -11- Code set for automation module	Can only be changed via keypad! If a password is defined under C094, a change from -0- to -1- or -2- is only possible after entering this password (+ PW): 1. Change C000, acknowledge with SH + PRG . 2. Password setting with ▲ or ▼ . 3. Accept with SH + PRG.																		
[C001]	Operating mode	0	<table border="0"> <tr> <td>Control</td> <td>Parameter setting</td> </tr> <tr> <td>-0- Terminals Keypad</td> <td></td> </tr> <tr> <td>-1- Keypad Keypad</td> <td></td> </tr> <tr> <td>-2- Terminals LECOM1</td> <td></td> </tr> <tr> <td>-3- LECOM1 LECOM1</td> <td></td> </tr> <tr> <td>-4- Terminals LECOM2 (*)</td> <td></td> </tr> <tr> <td>-5- LECOM2 (*) LECOM2 (*)</td> <td></td> </tr> <tr> <td>-6- LECOM2 (*) Keypad</td> <td></td> </tr> <tr> <td>-7- LECOM2 (*) LECOM1</td> <td></td> </tr> </table> (*) Fieldbus	Control	Parameter setting	-0- Terminals Keypad		-1- Keypad Keypad		-2- Terminals LECOM1		-3- LECOM1 LECOM1		-4- Terminals LECOM2 (*)		-5- LECOM2 (*) LECOM2 (*)		-6- LECOM2 (*) Keypad		-7- LECOM2 (*) LECOM1		With C001 = -2-, -3-, -4-, -5-, -7-, TRIP must be reset (C043) via the interface or the terminal. With LECOM2, TRIP reset is also possible via the control word of the process data channel.
Control	Parameter setting																					
-0- Terminals Keypad																						
-1- Keypad Keypad																						
-2- Terminals LECOM1																						
-3- LECOM1 LECOM1																						
-4- Terminals LECOM2 (*)																						
-5- LECOM2 (*) LECOM2 (*)																						
-6- LECOM2 (*) Keypad																						
-7- LECOM2 (*) LECOM1																						
[C002]	Load parameter set	0	-0- Factory setting -1- Parameter set 1 -2- Parameter set 2 -3- Parameter set 3 -4- Parameter set 4	Parameter set 1 is automatically loaded after mains connection. If another parameter set is selected via terminal, this parameter set will also be loaded.																		
C003	Save parameter set	1	-1- Parameter set 1 -2- Parameter set 2 -3- Parameter set 3 -4- Parameter set 4																			
C004	Switch-on display	83	0 {1} 999	Code No. for switch-on display: Can only be changed if C001= -0-, -1-, -6-																		

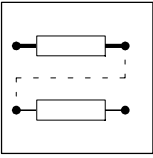

Configuration

Code	Name	Possible settings		
		Lenze	Selection	Info
[C005*]	Configuration	11	<p>Speed control with additional setpoint</p> <p>-10- Armature voltage control n_{set}: analog at X1/8 n_{add}: analog at X1/6 M_{limit}: analog at X1/1, 1/2.</p> <p>-11- Act. value encoder: tacho at X1/3,X1/4 n_{set}: analog at X1/8 n_{add}: analog at X1/6 M_{limit}: analog at X1/1, X1/2</p> <p>-12- Act. value encoder: resolver at X7 n_{set}: analog at X1/8 n_{add}: analog at X1/6 M_{limit}: analog at X1/1, X1/2</p> <p>-13- Act. value encoder: increment. encoder at X9 n_{set}: analog at X1/8 n_{add}: analog at X1/6 M_{limit}: analog at X1/1, X1/2</p> <p>Torque control with speed limitation and additional setpoint</p> <p>-40- Armature voltage control n_{set}: analog at X1/8 n_{add}: analog at X1/6 M_{set}: analog at X1/1, 1/2.</p> <p>-41- Act. value encoder: tacho at X1/3, X1/4 n_{set}: analog at X1/8 n_{add}: analog at X1/6 M_{set}: analog at X1/1, 1/2.</p> <p>-42- Act. value encoder: resolver at X7 n_{set}: analog at X1/8 n_{add}: analog at X1/6 M_{set}: analog at X1/1, X1/2</p> <p>-43- Act. value encoder: increment. encoder at X9 n_{set}: analog at X1/8 n_{add}: analog at X1/6 M_{set}: analog at X1/1, X1/2</p> <p>Dig. freq. of master with additional setpoint</p> <p>-52- Act. value encoder: resolver at X7 n_{set}: analog at X1/8 n_{add}: analog at X1/6 M_{limit}: analog at X1/1, X1/2</p> <p>-53- Act. value encoder: increment. encoder at X5 n_{set}: analog at X1/8 n_{add}: analog at X1/6 M_{limit}: analog at X1/1, X1/2</p> <p>Digital frequency bus</p> <p>-62- Act. value encoder: resolver at X7 n_{set}: digital at X9 M_{limit}: analog at X1/1, X1/2</p> <p>-63- Act. value encoder: increment. encoder at X5 n_{set}: digital at X9 M_{limit}: analog at X1/1, X1/2</p> <p>Digital frequency cascade</p> <p>-72- Actual value encoder: resolver at X7 n_{set}: digital, X5 M_{limit}: analog at X1/1, X1/2</p>	<p>If C005 = -10- or -40-, field control override is not possible.</p> <p>A change of the configuration changes the control structure and the terminal assignment and activates important monitoring functions.</p> <p>Change monitoring functions: C119 / C120</p> <p>Change terminal signals: C145 / C146.</p>
C009*	Controller address	1	1 {1} 99	<p>Bus participant number for operation via interface: Parameter 10 reserved for broadcasting to groups of participants. Can only be changed with C001 = -0- and -1-.</p>

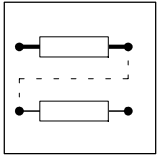

Code	Name	Possible settings				Info
		Lenze	Selection			
C011	n_{\max} speed	3000 rpm	250 rpm	{1 rpm}	5000 rpm	n_{\max} is the reference for the analog and relative setpoint selection as well as for the acceleration and deceleration times. Parameter setting via interface: Inhibit the controller before substantial parameters changes.
C012	Acceleration time T_{ir} for main setpoint	0.00s	0.00 s 1 s 10 s 100 s	{0.01 s} {0.1 s} {1 s} {10 s}	1 s 10 s 100 s 990 s	Time refers to 0... n_{\max}
C013	Deceleration time T_{if} for main setpoint	0.00s	0.00 s 1 s 10 s 100 s	{0.01 s} {0.1 s} {1 s} {10 s}	1 s 10 s 100 s 990 s	Time refers to 0... n_{\max}
C017*	Threshold n_{act} n_x	-3000 rpm	-5000 rpm	{1 rpm}	+5000 rpm	If the actual speed falls below the comparison speed n_x , the corresponding output will be activated.
C019*	Threshold $n_{act} = 0$	50 rpm	0 rpm	{1 rpm}	5000 rpm	If the actual speed falls below the threshold, the corresponding output will be activated.
C022	+ I_{\max} limit	Rated controller current	Current limit of thyristor bridge 1			Current limit depends on controller: 29A (4902) 45A (4903) 90A (4904) 150A (4905) 240A (4906) 300A (4907) 400A (4X08) 600A (4X09) 840A (4X11) 1200A (4X12) 1350A (4X13)
C023	- I_{\max} limit		Current limit of thyristor bridge 2			
C025	Input selection: Input adjustment	2	-1- -2- -3- -4- -5- -10 -11- -12- -13-	Terminals X1/1, X1/2 Terminals X1/3, X1/4 Terminal X1/6 Terminal X1/8 Armature voltage feedback Digital frequency input X5 Digital frequency input X9 Resolver X7 Encoder output X8	Select (under C025) the input which is to be adjusted with C026, C027, C028 or C029.	

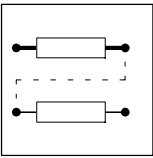

Configuration

Code	Name	Possible settings		Info
		Lenze	Selection	
C026	Encoder constant for C025	0mV	C025 = -1-, -2-, -3-, -4-: Offset correction of the analog inputs -9999mV {1mV} +9999mV	The encoder constants are not overwritten the factory setting is loaded.
		0V	C025 = -5-: Offset correction of the armature voltage feedback -100V {1V} +100V	
		1	C025 = -10-, -11-: Encoder constant of the digital frequency inputs -0- 8192 increments / revolution -1- 4096 increments / revolution -2- 2048 increments / revolution -3- 1024 increments / revolution -4- 512 increments / revolution -5- 256 increments / revolution	
		3	C025 = -13-: Encoder constant of the encoder outputs with resolver feedback -1- 256 increments / revolution -2- 512 increments / revolution -3- 1024 increments / revolution -4- 2048 increments / revolution	
C027	Gain factor for C025	1.000	C025 = -1-, -2-, -3-, -4-: Gain factor of the analog inputs -2.500 {0.001} +2.500	If an analog signal source (C145/C146) is assigned, only the parameter will be displayed.
		1.000	C005 = -11-, -41-: Gain factor of the tachometer input X1/3, X1/4 0.010 {0.001} +9.999	
		1.010	C025 = -5-: Gain factor of the armature voltage feedback 0.100 {0.001} +9.999	
		0.1000	C025 = -10-, -11-: Gain factor of the digital frequency inputs -3.2767 {0.0001} +3.2767	
		1.000	C025 = -12-: Gain factor of the resolvers -32.767 {0.001} +32.767	
C028	Divisor for C025	0.1000	C025 = -10-, -11-: Divisor for the digital frequency inputs 0.0001 {0.0001} 3.2767	
C029	Automatic adjustment for C025			Applies to all configurations: If an automatic adjustment is not possible, the previous value will be maintained. --ok-- will not be displayed.
			C025 = -1-, -2-, -3-, -4-: Automatic adjustment for analog inputs -100% {0.1%} 100.0%	1. Inhibit controller. 2. Set the setpoint at the terminal selected 3. Enter the corresponding value. 4. C027 displays the calculated gain factor
			C025 = -2- and tachometer at X1/3, X1/4 or C025 = -5- and actual value from armature voltage feedback: n_{act} adjustment 0 rpm {1rpm} 5000rpm	Adjustment during operation: 1. Display of actual speed. 2. Measure real speed with hand tachometer. 3. Enter real speed. 4. Drive accelerates to this speed. 5. C027 displays the calculated gain factor.

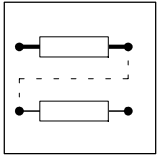

Code	Name	Possible settings		
		Lenze	Selection	Info
C029	Automatic adjustment for C025		C025 = -10-, -11-: Adjustment of the digital frequency inputs X5, X9 -100.0% {0.1%} 100.0%	Automatic adjustment only possible, if X5 or X9 are not selected as actual speed inputs: 1. Display of actual output value. 2. Enter required output value. 3. C027 displays the calculated gain factor.
			C025 = -12-: Adjustment of the resolver -100.0% {0.1%} 100.0%	Automatic adjustment is only possible, if the resolver is not used as a speed feedback system: 1. Display of actual output value. 2. Enter required output value. 3. C027 displays the calculated gain factor.
C030	Constant for the digital frequency output	1	-0- 8192 increments / revolution -1- 4096 increments / revolution -2- 2048 increments / revolution -3- 1024 increments / revolution -4- 512 increments / revolution -5- 256 increments / revolution	Number of increments per revolution for the digital frequency output
C032*	Ratio numerator	0.1000	-3.2767 {0.0001} 3.2767	Ratio numerator for configurations with digital frequency If an analog signal source is assigned (C145/146), only the parameter will be displayed.
C033*	Ratio denominator	0.1000	0.0001 {0.0001} 3.2767	Ratio denominator for configurations with digital frequency
C034*	Master current	0	-0- $i_{\text{master}} = -20 \text{ mA} \dots +20 \text{ mA}$ -1- $ i_{\text{master}} = 4 \text{ mA} \dots 20 \text{ mA}$	For master current input, the switch S3/1 must be set to ON. C034 = -1-: If $i_{\text{master}} < 2 \text{ mA}$, the monitoring message Sd5 will be displayed.
C038	Input selection: JOG setpoint	1	-1- Selection JOG1 -2- Selection JOG2 ... -15- Selection JOG15	Select JOG setpoint to be set under C039.
C039	JOG speed for C038		-100.0 % n_{max} {0.1 %} + 100.0 % n_{max} 100.0% JOG1 75.0% JOG2 50.0% JOG3 25.0% JOG4 0.0% JOG5 0.0% JOG15	Enable JOG setpoints via the digital inputs or via C045.
C040	Controller enable		-0- Controller inhibited -1- Controller enabled	Input only via LECOM1 or LECOM2. C183 indicates the source which has inhibited the controller.
C041	CW/CCW direction of rotation		-0- Main setpoint not inverted -1- Main setpoint inverted	Input only with control via keypad or interface. Display only with terminal control.
C042	Quick stop		-0- No quick stop (corresponds to X2/21 or X2/22 = HIGH) -1- Quick stop active (corresponds to X2/21 and X2/22 = LOW) Drives decelerates to standstill following the quick-stop ramp C105.	Input only with control via keypad or interface. Display only with terminal control.

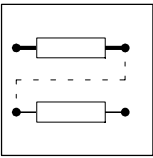

Configuration

Code	Name	Possible settings			Info
		Lenze	Selection		
C043*	TRIP reset		-0- Read: no fault Write: reset fault		Only selectable via the interfaces.
			-1- Read: fault		
C045	JOG enable	0	-0- Main setpoint (C046) active -1- Setpoint JOG1 active ... -15- Setpoint JOG15 active		Display only with terminal control.
C046	n_{set} speed		-100.0 % n_{max} {0.1 %} + 100.0 % n_{max}		Display only with terminal control. If the terminal control is deactivated, the actual terminal value will be accepted for operation.
C047	Torque limit		-100.0 % M_{max} {0.1 %} + 100.0 % M_{max}		Display only with terminal control. If the terminal control is deactivated, the actual terminal value will be accepted for operation. Armature setting range: 100 % M_{max} correspond to 100 % I_{max} (C022, C023)
C049	Additional setpoint		-100.0 % n_{max} {0.1 %} + 100.0 % n_{max}		Display: additional setpoint from terminal
C050	n_{set} at controller		-180.0 % n_{max} {0.1 %} + 180.0 % n_{max}		Display: speed setpoint at the input of the speed controller
C051	n_{act} speed		-5000 rpm {1 rpm} + 5000 rpm		Display: actual speed
C052*	Motor voltage		0 V {1 V} 600 V		Display: motor voltage V_A
C054	Motor current		0.0 A {0.1 A} 100 A 100 A {1 A} 2000 A		Display: motor current
C056	Torque setpoint		-100.0 % M_{max} {0.1 %} + 100.0 % M_{max}		Display: Torque setpoint Armature setting range: 100% M_{max} correspond to 100% I_{max} (C022, C023)
C060*	Rotor position		0...2047		Display of the absolute angle position of the rotor, standardized to 2048 incr./rev. With incremental encoder feedback, display only after zero track pulse occurred.
C061*	I_t load		0,0 % {0.1 %} 105,0%		Display: "I t load" Starting value when switching on the mains is always 100 % !
C063	I_{set} at controller		-100.0 % I_{max} {0.1 %} + 100.0% I_{max}		Display: current setpoint at current controller input

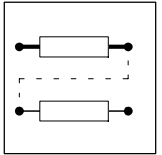

Code	Name	Possible settings		Info																																								
		Lenze	Selection																																									
C065	Fault indication: message		<table border="0"> <thead> <tr> <th>Display</th> <th>Meaning</th> </tr> </thead> <tbody> <tr> <td>---</td> <td>no message</td> </tr> <tr> <td>EEr</td> <td>external TRIP (from terminal)</td> </tr> <tr> <td>LF</td> <td>mains frequency fault $f_{\text{mains}} < 47\text{Hz}$</td> </tr> <tr> <td>LU</td> <td>Undervoltage</td> </tr> <tr> <td>LU1</td> <td>faulty phase, mains interruptions</td> </tr> <tr> <td>OF</td> <td>mains frequency fault $f_{\text{mains}} > 63\text{Hz}$</td> </tr> <tr> <td>P03</td> <td>following error (tolerance exceeded)</td> </tr> </tbody> </table>	Display	Meaning	---	no message	EEr	external TRIP (from terminal)	LF	mains frequency fault $f_{\text{mains}} < 47\text{Hz}$	LU	Undervoltage	LU1	faulty phase, mains interruptions	OF	mains frequency fault $f_{\text{mains}} > 63\text{Hz}$	P03	following error (tolerance exceeded)	<p>When a message occurs:</p> <ol style="list-style-type: none"> 1. The display changes to C065. 2. The message blinks until the fault is reset. Depending on the configuration of C119 / C120, the drive can inhibit itself while the message is displayed and restart when the fault has been reset. 3. The message is entered into the history buffer of C065. The last 8 entries can be displayed by pressing sind mit ▼ and ▲. The message saved last is displayed first. The history buffer is cleared when switching on the mains. 																								
Display	Meaning																																											
---	no message																																											
EEr	external TRIP (from terminal)																																											
LF	mains frequency fault $f_{\text{mains}} < 47\text{Hz}$																																											
LU	Undervoltage																																											
LU1	faulty phase, mains interruptions																																											
OF	mains frequency fault $f_{\text{mains}} > 63\text{Hz}$																																											
P03	following error (tolerance exceeded)																																											
C066	Fault indication: Warning		<table border="0"> <thead> <tr> <th>Display</th> <th>Meaning</th> </tr> </thead> <tbody> <tr> <td>---</td> <td>no warning</td> </tr> <tr> <td>ACI</td> <td>armature circuit break</td> </tr> <tr> <td>CE0</td> <td>communication error (automation interface)</td> </tr> <tr> <td>CE9</td> <td>communication error (serial interface)</td> </tr> <tr> <td>dEr</td> <td>motor blocked or field break</td> </tr> <tr> <td>EEr</td> <td>external TRIP (from terminal)</td> </tr> <tr> <td>FCI</td> <td>interruption of the excitation circuit</td> </tr> <tr> <td>OC5</td> <td>I_t overload (controller protection)</td> </tr> <tr> <td>OC6</td> <td>$I^2 t$ overload (motor protection)</td> </tr> <tr> <td>OH</td> <td>overtemperature heat sink</td> </tr> <tr> <td>QUE</td> <td>mains overvoltage</td> </tr> <tr> <td>P03</td> <td>following error (tolerance exceeded)</td> </tr> <tr> <td>Sd1</td> <td>short circuit or interruption of tacho</td> </tr> <tr> <td>Sd2</td> <td>open circuit of resolver</td> </tr> <tr> <td>Sd3</td> <td>encoder fault at X5</td> </tr> <tr> <td>Sd4</td> <td>encoder fault at X9</td> </tr> <tr> <td>Sd5</td> <td>master current $< 2\text{mA}$ with C034 = -1-</td> </tr> <tr> <td>SP</td> <td>wrong signal source polarity</td> </tr> <tr> <td>U15</td> <td>15V supply voltage is missing</td> </tr> </tbody> </table>	Display	Meaning	---	no warning	ACI	armature circuit break	CE0	communication error (automation interface)	CE9	communication error (serial interface)	dEr	motor blocked or field break	EEr	external TRIP (from terminal)	FCI	interruption of the excitation circuit	OC5	I_t overload (controller protection)	OC6	$I^2 t$ overload (motor protection)	OH	overtemperature heat sink	QUE	mains overvoltage	P03	following error (tolerance exceeded)	Sd1	short circuit or interruption of tacho	Sd2	open circuit of resolver	Sd3	encoder fault at X5	Sd4	encoder fault at X9	Sd5	master current $< 2\text{mA}$ with C034 = -1-	SP	wrong signal source polarity	U15	15V supply voltage is missing	<p>When a warning occurs:</p> <ol style="list-style-type: none"> 1. The display changes to C066. 2. The warning blinks until the fault is reset. 3. The warning is entered into the history buffer of C066. <p>The last 8 entries can be displayed by pressing ▼ and ▲. The message saved last is displayed first. The history buffer isn't cleared when the mains is switched on.</p>
Display	Meaning																																											
---	no warning																																											
ACI	armature circuit break																																											
CE0	communication error (automation interface)																																											
CE9	communication error (serial interface)																																											
dEr	motor blocked or field break																																											
EEr	external TRIP (from terminal)																																											
FCI	interruption of the excitation circuit																																											
OC5	I_t overload (controller protection)																																											
OC6	$I^2 t$ overload (motor protection)																																											
OH	overtemperature heat sink																																											
QUE	mains overvoltage																																											
P03	following error (tolerance exceeded)																																											
Sd1	short circuit or interruption of tacho																																											
Sd2	open circuit of resolver																																											
Sd3	encoder fault at X5																																											
Sd4	encoder fault at X9																																											
Sd5	master current $< 2\text{mA}$ with C034 = -1-																																											
SP	wrong signal source polarity																																											
U15	15V supply voltage is missing																																											

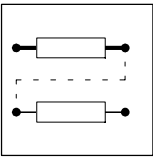

Configuration

Code	Name	Possible settings																																																																		
		Lenze	Selection	Info																																																																
C067	Fault indication: TRIP		<table border="1"> <thead> <tr> <th>Display</th> <th>Meaning</th> </tr> </thead> <tbody> <tr><td>---</td><td>no fault at present</td></tr> <tr><td>ACI</td><td>armature circuit break</td></tr> <tr><td>CCr</td><td>System fault</td></tr> <tr><td>CE0</td><td>communication error (automation interface)</td></tr> <tr><td>CE9</td><td>communication error (serial interface)</td></tr> <tr><td>dEr</td><td>motor blocked or field break</td></tr> <tr><td>EEr</td><td>external TRIP (from terminal)</td></tr> <tr><td>FCI</td><td>break excitation circuit</td></tr> <tr><td>LF</td><td>mains frequency fault $f_{\text{mains}} < 47\text{Hz}$</td></tr> <tr><td>LU</td><td>Undervoltage</td></tr> <tr><td>LU1</td><td>faulty phase, mains break</td></tr> <tr><td>OC5</td><td>I_t overload (controller protection)</td></tr> <tr><td>OC6</td><td>$I^2 t$ overload (motor protection)</td></tr> <tr><td>OF</td><td>mains frequency fault $f_{\text{mains}} > 63\text{Hz}$</td></tr> <tr><td>OH</td><td>overtemperature heat sink</td></tr> <tr><td>OUE</td><td>mains overvoltage</td></tr> <tr><td>P03</td><td>following error (tolerance exceeded)</td></tr> <tr><td>P13</td><td>angle overrun (angle difference cannot be compensated any longer)</td></tr> <tr><td>PER</td><td>software error (please contact Lenze)</td></tr> <tr><td>PR</td><td>all parameters reset (factory setting)</td></tr> <tr><td>PR1</td><td>parameter set 1 reset (factory setting)</td></tr> <tr><td>PR2</td><td>parameter set 2 reset (factory setting)</td></tr> <tr><td>PR3</td><td>parameter set 3 reset (factory setting)</td></tr> <tr><td>PR4</td><td>parameter set 4 reset (factory setting)</td></tr> <tr><td>Sd1</td><td>short circuit or interruption of tacho</td></tr> <tr><td>Sd2</td><td>open circuit of resolver</td></tr> <tr><td>Sd3</td><td>encoder fault at X5</td></tr> <tr><td>Sd4</td><td>encoder fault at X9</td></tr> <tr><td>Sd5</td><td>master current $< 2\text{ mA}$ with C034 = -1-</td></tr> <tr><td>SP</td><td>wrong signal source polarity</td></tr> <tr><td>U15</td><td>15V supply voltage is missing</td></tr> </tbody> </table>	Display	Meaning	---	no fault at present	ACI	armature circuit break	CCr	System fault	CE0	communication error (automation interface)	CE9	communication error (serial interface)	dEr	motor blocked or field break	EEr	external TRIP (from terminal)	FCI	break excitation circuit	LF	mains frequency fault $f_{\text{mains}} < 47\text{Hz}$	LU	Undervoltage	LU1	faulty phase, mains break	OC5	I_t overload (controller protection)	OC6	$I^2 t$ overload (motor protection)	OF	mains frequency fault $f_{\text{mains}} > 63\text{Hz}$	OH	overtemperature heat sink	OUE	mains overvoltage	P03	following error (tolerance exceeded)	P13	angle overrun (angle difference cannot be compensated any longer)	PER	software error (please contact Lenze)	PR	all parameters reset (factory setting)	PR1	parameter set 1 reset (factory setting)	PR2	parameter set 2 reset (factory setting)	PR3	parameter set 3 reset (factory setting)	PR4	parameter set 4 reset (factory setting)	Sd1	short circuit or interruption of tacho	Sd2	open circuit of resolver	Sd3	encoder fault at X5	Sd4	encoder fault at X9	Sd5	master current $< 2\text{ mA}$ with C034 = -1-	SP	wrong signal source polarity	U15	15V supply voltage is missing	<p>When a TRIP occurs:</p> <ol style="list-style-type: none"> The display changes to C067. TRIP blinks until the fault and the memory are reset. Reset memory: with SH+ PRG or via the input TRIP-Reset, with LECOM via C043 or via the input TRIP-Reset TRIP is entered into the history buffer of C067. The last 8 entries can be displayed by pressing ▼ and ▲. The TRIP saved last is displayed first. The history buffer isn't cleared when the mains switched on. <p>After PR-TRIP, the code C180 must be reset to 2Q operation for controllers 48XX or for 2Q applications.</p>
Display	Meaning																																																																			
---	no fault at present																																																																			
ACI	armature circuit break																																																																			
CCr	System fault																																																																			
CE0	communication error (automation interface)																																																																			
CE9	communication error (serial interface)																																																																			
dEr	motor blocked or field break																																																																			
EEr	external TRIP (from terminal)																																																																			
FCI	break excitation circuit																																																																			
LF	mains frequency fault $f_{\text{mains}} < 47\text{Hz}$																																																																			
LU	Undervoltage																																																																			
LU1	faulty phase, mains break																																																																			
OC5	I_t overload (controller protection)																																																																			
OC6	$I^2 t$ overload (motor protection)																																																																			
OF	mains frequency fault $f_{\text{mains}} > 63\text{Hz}$																																																																			
OH	overtemperature heat sink																																																																			
OUE	mains overvoltage																																																																			
P03	following error (tolerance exceeded)																																																																			
P13	angle overrun (angle difference cannot be compensated any longer)																																																																			
PER	software error (please contact Lenze)																																																																			
PR	all parameters reset (factory setting)																																																																			
PR1	parameter set 1 reset (factory setting)																																																																			
PR2	parameter set 2 reset (factory setting)																																																																			
PR3	parameter set 3 reset (factory setting)																																																																			
PR4	parameter set 4 reset (factory setting)																																																																			
Sd1	short circuit or interruption of tacho																																																																			
Sd2	open circuit of resolver																																																																			
Sd3	encoder fault at X5																																																																			
Sd4	encoder fault at X9																																																																			
Sd5	master current $< 2\text{ mA}$ with C034 = -1-																																																																			
SP	wrong signal source polarity																																																																			
U15	15V supply voltage is missing																																																																			
C068	Operating state		<table border="1"> <thead> <tr> <th>Bit</th> <th>Meaning</th> </tr> </thead> <tbody> <tr><td>0-3</td><td>Operation error (bit-decoded)</td></tr> <tr><td>4-7</td><td>Communication error (bit-coded)</td></tr> <tr><td>8</td><td>Controller enable</td></tr> <tr><td>9</td><td>$n_{\text{act}} = 0$</td></tr> <tr><td>10</td><td>Setpoint inversion</td></tr> <tr><td>11</td><td>Pulse inhibit</td></tr> <tr><td>12</td><td>Quick stop</td></tr> <tr><td>13</td><td>I_{max} limit reached</td></tr> <tr><td>14</td><td>$n_{\text{act}} = n_{\text{set}}$</td></tr> <tr><td>15</td><td>TRIP fault message</td></tr> </tbody> </table>	Bit	Meaning	0-3	Operation error (bit-decoded)	4-7	Communication error (bit-coded)	8	Controller enable	9	$n_{\text{act}} = 0$	10	Setpoint inversion	11	Pulse inhibit	12	Quick stop	13	I_{max} limit reached	14	$n_{\text{act}} = n_{\text{set}}$	15	TRIP fault message	<p>16 bit status information Only readable via LECOM. The signals are described in the Lecom-A/B protocol.</p>																																										
Bit	Meaning																																																																			
0-3	Operation error (bit-decoded)																																																																			
4-7	Communication error (bit-coded)																																																																			
8	Controller enable																																																																			
9	$n_{\text{act}} = 0$																																																																			
10	Setpoint inversion																																																																			
11	Pulse inhibit																																																																			
12	Quick stop																																																																			
13	I_{max} limit reached																																																																			
14	$n_{\text{act}} = n_{\text{set}}$																																																																			
15	TRIP fault message																																																																			

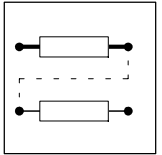

Code	Name	Possible settings				Info
		Lenze	Selection			
C069	Controller state		Bit	Meaning		8 bit status information Only readable via LECOM. The signals are described in the LECOM-A/B protocol.
			0	Operation error		
			1	Communication error		
			2	Operating mode was changed		
			3	Control via LECOM active		
			4	Control via terminals active		
			5	Controller reset (CCr fault)		
			6	not assigned		
			7	Controller enable		
C070	V_{pn} of the speed controller	8	1	{1}	1000	Gain adjustment of the speed controller: 1. With low motor speed, increase V_{pn} until the drive starts to oscillate (high frequency). 2. Reduce V_{pn} , until the drive runs smoothly.
[C071*]	T_{nn} of the speed controller	400 ms	20 ms	{10 ms}	2000 ms 9999 ms	Integral action time of the speed controller $T_{nn} = 9999$ ms: I-component switched-off (only when controller is inhibited)
C072*	K_{dn} of the speed controller	0	0 V_{pn}	{0.1}	5.0 V_{pn}	Differential component of the speed controller
C077*	V_{pl} of the field controller	1.0	0.1	{0.1}	5.0	Gain adjustment of the field controller
C078*	T_{nl} of the field controller	300 ms	70 ms	{10 ms}	2000 ms	Integral action time of the field controller
C079*	PT1 element Time constant for field controller attenuation	140 ms	30 ms	{10 ms}	9000 ms	The larger the time constant, the larger the decoupling between armature and field circuits.
C081*	Rated motor power	6.7 kW	0.0 kW 10kW	{0.1 kW} {1kW}	10.0 kW 1000kW	See motor nameplate
C083	Rated field current	0A	0 A	{0.01 A}	30.0 A	Rated current depends on the controller: 0A/0.1A ... 3.5A (4902, 4903) 0A/0.3A ... 10A (4904 - 4907) 0A/0.3A ... 15A (4X08) 0A/0.3A ... 30A (4X09 - 4X13) Data on the motor nameplate are setpoints for the field current. With very low field currents an auxiliary starting circuit should be provided.
C084*	CW/CCW armature time constant	10 ms	0 ms	{5 ms}	30 ms	Adaption of the current controller to compensated and uncompensated motors 0 ms = adaption not active
C085*	Thermal motor time constant	1.0min	1.0 min	{0.1 min}	100.0 min	Required for "I ² t monitoring" (motor protection)
C087	Rated motor speed	3000 rpm	300 rpm	{1 rpm}	5000 rpm	See motor nameplate

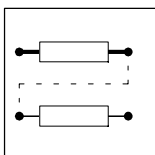

Configuration

Code	Name	Possible settings				Info
		Lenze	Selection			
C088	Rated motor current		0 A 100 A	{0.1A} {1A}	100 A 3600 A	Rated current depends on the controller: 0..87A (4902) 0..135A (4903) 0..270A (4904) 0..450A (4905) 0..720A (4906) 0..900A (4907) 0..1200A (4X08) 0..1800A (4X09) 0..2520A (4X11) 0..3600A (4X12) 0..4050A (4X13) See motor nameplate
C090	Rated motor voltage	420 V	150 V	{1 V}	650 V	See motor nameplate Observe max. permissible output voltage of the controller!
C093*	Controller identification		49XX			Display: controller type
C094*	User password	0	0	{1}	999	0 = No password protection (see also C000)
C098	Language	0	-0- German -1- English -2- French			
C099*	Software version		49 6.X			Display: Series and software version
C100*	Input selection: Additional acceleration and deceleration times for main setpoint		-1- Acceleration time T_{ir1} /deceleration time T_{if1} -2- Acceleration time T_{ir2} /deceleration time T_{if2} ... -15- Acceleration time T_{ir15} /deceleration time T_{if15}			Extends T_{ir} (C012) and T_{if} (C013) by max. 15 value pairs. Can be changed under C130: 1. Select additional times under C100. 2. Set under C101 (T_{ir}) or C103 (T_{if}).
C101*	Acceleration time for C100	0.00s	0 s 1 s 10 s 100 s	{0.01 s} {0.1s} {1 s} {10 s}	1 s 10s 100 s 990 s	Time refers to speed change $0...n_{max}$
C103*	Deceleration time for C100	0.00s	0 s 1 s 10 s 100 s	{0.01 s} {0.1s} {1 s} {10 s}	1 s 10s 100 s 990 s	Time refers to speed change $0...n_{max}$
C105	Deceleration time for quick stop	0.00s	0 s 1 s 10 s 100 s	{0.01 s} {0.1s} {1 s} {10 s}	1 s 10s 100 s 990 s	Time refers to speed change $0...n_{max}$
C108*	Gain for C110	1.00	-10.000 {0.001}	+ 10.000		Gain for X4/62, X4/63, X8
C109*	Offset for C110	0mV	-10000mV	{1mV}	+ 10000mV	Offset for X4/62, X4/63 Loading of the factory settings does not overwrite C109. This code is only effective if the digital frequency output is selected under C110.
C110*	Input selection: Monitor output	1	-1- Analog output X4/62 (monitor 1) -2- Analog output X4/63 (monitor 2) -3- Digital frequency output X8			The monitor outputs are freely assignable with the signals under C111: 1. Select monitor output under C110. 2. Assign signals under C111. 3. If necessary, adjust under C108 and C109.

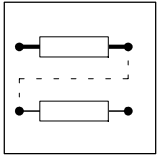

Code	Name	Possible settings		Info																																																
		Lenze	Selection																																																	
[C111*]	Signal for C110		-0- No signal -1- Main setpoint (C046), reference: n_{max} -2- Input ramp function generator, reference: n_{max} -3- Output ramp function generator, reference: n_{max} -4- Additional setpoint (C049), reference: n_{max} -5- n_{set} at n-controller input (C050), reference: n_{max} -6- n_{act} (C051), reference: n_{max} (X4/63) -8- n_{act} (C382), reference: n_{max} (X8) -20- n-controller output, reference: M_{max} -21- M_{set} (C047), reference: M_{max} -22- I_{set} (C063), reference: I_{max} (C022, C023), (X4/62) -23- I_{act} (C054), reference: (see 'Info') -25- M_{set} (C056), reference: M_{max} -28- I t load, reference: 100% -29- I^2 t load, reference: 100% -30- V_A (C052), reference: 1000 V -35- Mains frequency, reference: 30Hz = 0V, 70Hz = 10V -40- Fiel current setpoint, reference: max. controller field current I_{Fmax} -41- Actual field current, reference: I_{Fmax} -60- Output motor potentiometer, reference: 100% -61- Output process controller, reference: 100% -62- Output arithmetic block 2, reference: 100% -63- Digital frequency input X5, reference: 100% -64- Digital frequency input X9, reference: 100% -65- Resolver, reference: 100% -66- Digital / analog conversion 1 (C272), reference: 100% -67- Digital / analog conversion 2 (C273), reference: 100% -68- Motor power, reference: 5 V = P_{rated} -69- Motor torque, reference: 5 V = M_{rated} -70- Output dead band element, reference: 100% -71- Output DT1 element, reference: 100% -72- Output absolute value generator, reference: 100% -73- Output limiting element 1, reference: 100% -74- Output PT1 element, reference: 100% -75- Output arith.-block 3, reference: 100% -76- Output add.-block 1, reference: 100% -77- Output add.-block 2, reference: 100% -78- Output limiting element 2, reference: 100%	Armature setting range: 100 % M_{max} correspond to 100 % I_{max} (C022, C023) The actual armature current I_{act} (C054) is standardized, according to the controller: <table border="1"> <thead> <tr> <th>I_{act}</th> <th>X4/62, X4/63</th> <th>X8</th> <th>Type</th> </tr> </thead> <tbody> <tr> <td>16A</td> <td>4.4V</td> <td>110kHz</td> <td>4902</td> </tr> <tr> <td>25A</td> <td>4.7V</td> <td>118kHz</td> <td>4903</td> </tr> <tr> <td>55A</td> <td>4.8V</td> <td>120kHz</td> <td>4904</td> </tr> <tr> <td>110A</td> <td>4.9V</td> <td>122kHz</td> <td>4905</td> </tr> <tr> <td>200A</td> <td>6.4V</td> <td>159kHz</td> <td>4906</td> </tr> <tr> <td>250A</td> <td>4.4V</td> <td>110kHz</td> <td>4907</td> </tr> <tr> <td>330A</td> <td>5.2V</td> <td>129kHz</td> <td>4X08</td> </tr> <tr> <td>500A</td> <td>5.8V</td> <td>144kHz</td> <td>4X09</td> </tr> <tr> <td>700A</td> <td>5.8V</td> <td>144kHz</td> <td>4X11</td> </tr> <tr> <td>1000A</td> <td>5.8V</td> <td>146kHz</td> <td>4X12</td> </tr> <tr> <td>1200A</td> <td>7.0V</td> <td>175kHz</td> <td>4X13</td> </tr> </tbody> </table> <p>With C111 = -5- the selection depends on the configuration set under C005. If C005 = -6X-, -72- the signal C111 = -5- outputs the corresponding input pulse current.</p>	I_{act}	X4/62, X4/63	X8	Type	16A	4.4V	110kHz	4902	25A	4.7V	118kHz	4903	55A	4.8V	120kHz	4904	110A	4.9V	122kHz	4905	200A	6.4V	159kHz	4906	250A	4.4V	110kHz	4907	330A	5.2V	129kHz	4X08	500A	5.8V	144kHz	4X09	700A	5.8V	144kHz	4X11	1000A	5.8V	146kHz	4X12	1200A	7.0V	175kHz	4X13
I_{act}	X4/62, X4/63	X8	Type																																																	
16A	4.4V	110kHz	4902																																																	
25A	4.7V	118kHz	4903																																																	
55A	4.8V	120kHz	4904																																																	
110A	4.9V	122kHz	4905																																																	
200A	6.4V	159kHz	4906																																																	
250A	4.4V	110kHz	4907																																																	
330A	5.2V	129kHz	4X08																																																	
500A	5.8V	144kHz	4X09																																																	
700A	5.8V	144kHz	4X11																																																	
1000A	5.8V	146kHz	4X12																																																	
1200A	7.0V	175kHz	4X13																																																	

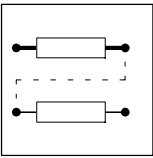

Configuration

Code	Name	Possible settings		Info
		Lenze	Selection	
C112*	Input selection: Freely assignable digital input	1	-1- digital input X2/E1 -2- digital input X2/E2 ... -5- digital input X2/E5	The digital inputs E1..E5 are freely assignable with the functions under C113. Each function can only be assigned to one input. Exceptions: <ul style="list-style-type: none"> • C113 = -20- : max. 2 dig. inputs • C113 = -1-, -2-, -40-: max. 4 dig. inputs (binary coded selection of max. 1, 3, 7 or 15 additional T_i times or setpoints). Assignment of functions: 1. Select input under C112. 2. Assign function under C113. 3. Determine polarity under C114. 4. Determine priority under C115.
[C113*]	Function for C112		-0- No function -1- Enable additional T _i times -2- Enable JOG setpoint (X4/E4, E5) -3- TRIP reset (X2/E2) -4- TRIP set (X2/E1) -6- Switch-off additional setpoint (X4/E3) -7- Switch-off I-component of the n-controller -9- Ramp function generator stop -10- Ramp function generator zero -16- Motor potentiometer deactivated -17- Motor potentiometer down -18- Motor potentiometer up -20- Select parameter set -21- Load parameter set -30- Deactivate process controller -31- Switch-off I-component of the process controller -32- Set the process controller to 0 -40- Enable fixed setpoint	
[C114*]	Polarity for C112	0	-0- Input HIGH active -1- Input LOW active	
[C115*]	Priority for C112		-0- Terminal function not active, if terminal control is switched-off under C001. (X2/E4, E5) -1- Terminal function remains active, if terminal control is switched-off under C001. (X2/E1, E2, E3)	
C116*	Input selection: Freely assignable digital output	1	-1- FDO 1 -2- FDO 2 ... -12- FDO 12 -13- Relay output X3/K11, X3/K14	The digital outputs FDO1..FDO12 and the relay output X3/K11, X3/K14 are freely assignable with the functions under C117. Multiple assignment is possible. The outputs FDO1...FDO5 are assigned to the terminals X3/A1...X3/A5. FDO6...FDO12 can only be accessed via LECOM. Assignment of functions: 1. Select output under C116. 2. Assign function under C117. Only for FDO1...FDO5, relay output: 3. Determine polarity under C118. 4. Determine signal delay under C128.

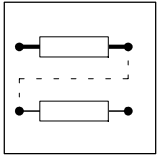

Code	Name	Possible settings		Info
		Lenze	Selection	
[C117*]	Function for C116		-0- No function -1- $n_{act} \neq n_x$ C017 (FDO1) -2- Controller enabled (FDO10) -3- n-controller output = M_{max} (FDO2) -4- Ready for operation (RDY) (FDO11) -5- Pulse inhibit (IMP) (FDO12) -6- TRIP (relay) -7- Warning (FDO6) -8- Message (FDO7) -9- Ramp function generator on = off (FDO3) -10- $n_{act} = n_{set}$ (FDO5) -11- $n_{act} = 0$ (FDO4) -12- $I_A = 0$ (FDO8) -13- I_A & $n_{act} = 0$ (FDO9) -14- $\leq C046$ $\leq C049$ $> n_x$ (threshold C243) -15- $ I_A > I_x$ (threshold C244) -16- $I_F > I_x$ (threshold C245) -17- $ n_{act} > n_x$ (threshold C242) -18- Brake control -19- Comparator 1 -20- Comparator 2	
[C118]	Polarity for C116		-0- Output is HIGH active (FDO2, 3, 5) -1- Output is LOW active (FDO1, 4, relay)	
C119*	Selection of monitoring function		-15- OC5 -16- OC6 -22- OUE -31- LU1 -32- LU -41- LF -42- OF -50- OH -61- CEO -70- U15 -80- SP -81- Sd1 -82- Sd2 -83- Sd3 -84- Sd4 -85- Sd5 -91- EEr -93- dEr -94- ACI -96- FCI -153- P03 -163- P13 -69- CE9	I t overload (controller protection) I ² t overload (motor protection) Mains overvoltage Phase fault Mains undervoltage Mains underfrequency $f_{mains} < 47\text{Hz}$ Mains overfrequency $f_{mains} > 63\text{Hz}$ Overtemperature heat sink Communication error (automation interface) 15V failure Wrong signal source polarity Tacho short-circuit/interruption Open circuit of resolver Encoder fault at X5 Encoder fault at X9 Defective setpoint encoder Ext. TRIP terminal Motor blocked Interruption of armature circuit Interruption of field circuit Following error Phase overflow Communication error (serial interface)
[C120*]	Change of monitoring function		-0- TRIP -1- Warning -2- Message with pulse inhibit -3- Message without pulse inhibit -4- Switched-off	The important monitoring functions are set according to the change of configuration under C005.

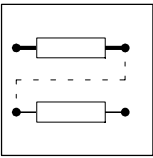

Configuration

Code	Name	Possible settings				Info
		Lenze	Selection			
C123	Current threshold for blocking protection for C124	0.95 I_{rated}	0 A 100 A	{0.1A} {1 A}	100 A 3600 A	Rated current depends on the controller: 0 ... 87A (4902) 0 ... 135A (4903) 0 ... 270A (4904) 0 ... 450A (4905) 0 ... 720A (4906) 0 ... 900A (4907) 0 ... 1200A (4X08) 0 ... 1800A (4X09) 0 ... 2520A (4X11) 0 ... 3600A (4X12) 0 ... 4050A (4X13) See motor nameplate
C124*	Blocking time	60 s	1 s	{1 s}	100 s	Motor standstill time until TRIP is set
C125*	Change of baud rate for interface	0	-0- -1- -2- -3-	9600 baud 4800 baud 2400 baud 1200 baud		
C126*	Delay (Monitoring ser. interface)	3000 s	0.2 s 10 s 100 s	{0.1 s} {1 s} {10 s}	10 s 100 s 3600 s	
C128*	Delay for C116	0.000 s	0.000 s	{0.001 s}	240.000 s	Signal delay times for FDO 1...5 and relay output.
C130*	Enable additional T_i times	0	-0- -1- ... -15-	T_{ir} (C012) / T_{if} (C013) active T_{ir1} / T_{if1} active T_{ir15} / T_{if15} active		If the T_i times are enabled via terminal, C130 is for display only.
C131*	Ramp function generator STOP	0	-0- -1-	Enable ramp function generator Stop ramp function generator		If ramp function generator STOP (main setpoint) is enabled via terminal, C131 is for display only.
C132*	Ramp function generator input = 0	0	-0- -1-	Enable mains setpoint at RFG input Ramp function generator input = 0		
[C134*]	Ramp function generator characteristic	0	-0- -1-	linear characteristic S-shaped characteristic		
C136*	FDI state		Bit 0 ... 3 4	Free digital input FDI 1 FDI 4 FDI 5		Only readable via LECOM. C136 indicates the states of the digital inputs as a decimal or binary value. The change of polarity under C114 is considered in C136.

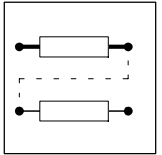

Code	Name	Possible settings		Info
		Lenze	Selection	
C145*	Input selection: Analog signal	1	-1- Input terminals X1/1, X1/2 -2- Input terminals X1/3, X1/4 -3- Input terminal X1/6 -4- Input terminal X1/8 -5- Digital frequency input X5 -6- Digital frequency input X9 -7- Resolver -8- Motor potentiometer output -9- Output process controller -10- Output arithmetic block 2 output 1 -11- Fixed setpoint output -12- Output arithmetic block 2 output 2 -13- Output dead band element output 1 -14- Output dead band element output 2 -15- Output DT1 element output 1 -16- Output DT1 element output 2 -17- Output absolute value generator output 1 -18- Output absolute value generator output 2 -19- Output limiting element 1 output 1 -20- Output limiting element 1 output 2 -21- Output PT1 element output 1 -22- Output PT1 element output 2 -23- Output arithmetic block 3 output 1 -24- Output arithmetic block 3 output 2 -25- Output addition block 1 output 1 -26- Output addition block 1 output 2 -27- Output addition block 2 output 1 -28- Output addition block 2 output 2 -29- n_{act} from C382 -30- n_{set} from C050 -31- Deviation at n-controller (xw) -32- Deviation at process controller (xw) -33- Ramp function generator output -34- n-controller output -35- Square-wave generator -36- Deviation at angle controller -37- RFG output of process controller setpoint conditioning -38- RFG output of process controller evaluation -39- AIF process controller setpoint -40- Output limiting element 2 output 1 -41- Output limiting element 2 output 2 -42- Output comparator 1 -43- Output comparator 2	<p>The functions set under C146 can be assigned to the input sources under C145. Double assignment is not possible. The function selected last is always assigned to the input.</p> <p>C145 = -1-, -2-, -3-, -4-, -5-, -6-: Determine the priority for these inputs under C147.</p> <p>If C005 (configuration) is changed: The freely selected assignments are overwritten with a configuration-dependent basic assignment. If necessary, reassign functions.</p>

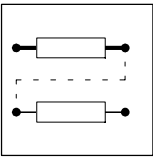

Configuration

Code	Name	Possible settings		Info
		Lenze	Selection	
[C146*]	Function for C145		-0- No function -1- Main setpoint of C046 -2- Input for torque selection -3- Additional setpoint of C049 -4- V_{pn} of the speed controller -5- Field current setpoint -6- Process controller: setpoint (C330) -7- Process controller: actual value -8- Process controller: evaluation (C331) -9- Process controller: ext. V_p setting -10- C027 of X5 -11- C027 of X9 -12- Gearbox factor (C032) -13- Angle trimming of C256 -14- Speed trimming of C257 -15- Arithmetic block 2 - input 1 (C338) -16- Arithmetic block 2 - input 2 (C339) -17- Fixed setpoint block input -18- Analog / digital conversion 1 (C270) -19- Analog / digital conversion 2 (C271) -20- Dead band element input (C622) -21- DT1 element input (C652) -22- Absolute value generator input (C660) -23- Limiting element input (C632) -24- PT1 element input (C641) -25- Arithmetic block 3 - input 1 (C601) -26- Arithmetic block 3 - input 2 (C602) -27- Addition block 1 - input 1 (C610) -28- Addition block 1 - input 2 (C611) -29- Addition block 1 - input 3 (C612) -30- Addition block 2 - input 1 (C614) -31- Addition block 2 - input 2 (C615) -32- Addition block 2 - input 3 (C616) -33- Additional torque setpoint 1 (C148) -34- Additional torque setpoint 2 (C149) -35- FAI input of the S&H module -36- AIF process controller: act. value -37- Limiting element 2 input (C637) -38- Comparator 1 input 1 (C580) -39- Comparator 1 input 2 (C581) -40- Comparator 2 input 1 (C590) -41- Comparator 2 input 2 (C591) -42- Input for ext. excitation characteristic -43- n_{act} of C051 (for tachometer feedback) -44- n_{act} of C051 (for resolver or incremental encoder feedback) -46- Digital frequency setpoint	<p>C146 = -4- V_{pn} of the n-controller corresponds to 0% at the input V_{p2} under C320 and 100% at the input V_{pn} under C070.</p> <p>C146 = -5- field current setpoint correspond to 100% at the input of the rated current under C083. The minimum adjustable value is determined under C231.</p> <p>C146 = -43-, -44-, -46- are for display only (according to the configuration). They cannot be assigned.</p>
[C147*]	Priority for C145		-0- Terminal function not active, if terminal control is switched-off under C001. -1- Terminal function remains active, if terminal control is switched-off under C001.	

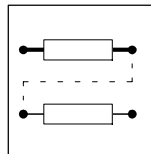

Code	Name	Possible settings			Info	
		Lenze	Selection			
C148	Additional torque value 1	0	-100.0 % M_{max} -200 % M_{max}	{0.1%} {1%}	+ 100.0 % M_{max} + 200 % M_{max}	Display only with terminal control. If the terminal control is deactivated, the actual terminal value will be accepted for operation. Armature setting range: 100 % M_{max} correspond to 100 % I_{max} (C022, C023)
C149	Additional torque value 2	0	-100.0 % M_{max} -200 % M_{max}	{0.1%} {1%}	+ 100.0 % M_{max} + 200 % M_{max}	Display only with terminal control. If the terminal control is deactivated, the actual terminal value will be accepted for operation. Armature setting range: 100 % M_{max} correspond to 100 % I_{max} (C022/C023)
C151*	FDO Status		Bit 0 ... 11 12	Free digital output FDO 1 FDO 12 Relay output		C151 indicates the states of the digital outputs as decimal or binary values. The polarity reversal under C118 is not considered.
[C180*]	4Q/2Q operation		-0- -1-	4Q operation (49XX) 2Q operation (48XX)		Important for controller type 48XX: Controllers must only be operated with C180 = -1-! Fault PR sets C180 = -0-. It is absolutely necessary to set C180 = -1- before commissioning.
C182*	T_i time of the S-shape ramp function generators	20.0 s	0.01 s 1s 10s	{0.01s} {0.1s} {1s}	1 s 10s 50s	T_i time for the S-shape ramp function generator of the main setpoint
C183	Origin of controller inhibit		Display Terminal or term. Keypad or kp LECOM1 or L1 Aut.int. (AIF) oth. src. or o.s.	Origin of ctrl inhibit Terminal Keypad (STP key) LECOM1 interface Automation / fieldbus interface (module, InterBus, PROFIBUS, ...) Other source Release: TRIP or message Information: C065, C067		Display: Source which has inhibited the controller
C185	Motor power		-500.0 kW -999 Nm	{0.1 kW} {1 Nm}	500.0 kW 999 Nm	Display: actual motor power
C186	Motor torque					Display: actual motor torque
C187	Field current setpoint		0.00 A	{0.01 A}	50.0 A	Display: actual field current setpoint
C188	Actual field current		0.00 A	{0.01 A}	50.0 A	Display: actual field current value
C189	Mains frequency		0.0 Hz	{0.1 Hz}	100.0 Hz	Display: actual mains frequency
C190*	Arithmetic block 1	1	-0- -1- -2- -3- -4- -5-	Output = C046 Output = C046 + C049 Output = C046 - C049 Output = C046 C049 Output = C046 / C049 Output = C046 / (100% - C049)		
C191*	Arithmetic block 2	1	-0- -1- -2- -3- -4- -5-	Output = C338 Output = C338 + C339 Output = C338 - C339 Output = C338 C339 Output = C338 / C339 Output = C338 / (100% - C339)		

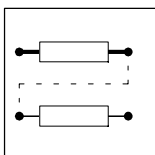

Configuration

Code	Name	Possible settings			Info	
		Lenze	Selection			
C192*	Input selection: Fixed setpoint	1	-1- -2- ... -15-	Selection fixed setpoint 1 Selection fixed setpoint 2 Selection fixed setpoint 15	It is possible to set up to 15 setpoints with freely selectable references: 1. Select fixed setpoint under C192. 2. Assign value under C193. 3. Enable via the digital inputs or C194.	
C193*	Setpoint for C192		-100.0 % 100.0% 75.0% 50.0% 25.0% 0.0% ... 0.0%	{0.1 %} Fixed setpoint 1 Fixed setpoint 2 Fixed setpoint 3 Fixed setpoint 4 Fixed setpoint 5 Fixed setpoint 15		
C194*	Enable fixed setpoint	0	-0- -1- ... -15-	Free input is active Fixed setpoint 1 is active Fixed setpoint 15 is active		
C195*	Delay between 'engage brake' and controller inhibit	9999 s	0.00s 1s 10s	{0.01 s} {0.1s} {1s}	1s 10s 250s 9999 s	Delay between signal 'engage brake' and automatic controller inhibit 9999 s: Unlimited delay, controller will not be inhibited.
C196*	Delay between 'setpoint integrator free' and quick stop	0.00s	0.00 s 1s 10s 100s	{0.01 s} {0.1s} {1s} {10s}	1 s 10s 100s 250s	Delay between reset of the quick stop function and enable of the main setpoint integrator
[C197*]	Sign of the torque selection	0	-0- -1- -2-	Sign is determined by the torque setpoint positive sign negative sign	Sign of the torque selection between reset of QSP and enable of the setpoint integrators	
[C198*]	Enable actual speed filter	0	-0- -1-	Filter not active Filter active		
C199*	Time constant act. speed filter	10ms	8ms	{1ms}	100ms	
C200*	Software identification		String format: "33S4902M_61000"		Display of the software version only via interface.	
C220*	Acceleration time T_{ir} of the additional setpoint	0.00 s	0.00 s 1 s 10 s 100 s	{0.01 s} {0.1 s} {1 s} {10 s}	1 s 10 s 100 s 990 s	
C221*	Deceleration time T_{if} of the additional setpoint	0.00 s	0.00 s 1 s 10 s 100 s	{0.01 s} {0.1 s} {1 s} {10 s}	1 s 10 s 100 s 990 s	
C222*	V_p process controller	1	0.1 10	{0.1} {1.0}	10 500	Gain of the process controller
[C223*]	T_n process controller	400 ms	20 ms	{1ms}	20000 ms 9999 ms	$T_n = 9999$ ms: I-component switched-off (only when controller is inhibited)
C224*	K_d process controller	0.0	0.0 V_{pn}	{0.1 V_{pn} }	5.0 V_{pn}	Differential component of the process controller
[C230*]	Control mode for the override field control	0	-0- -1-	Limitation of the armature voltage Control of the armature voltage	Field weakening must be permitted under C231.	

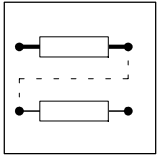

Code	Name	Possible settings				Info
		Lenze	Selection			
C231*	Min. field current	100%	10 % I_{Frated}	{1% I_{Frated} }	100% I_{Frated}	Reference: I_{Frated} (C083), observe min. value under C083!
C232*	I R compensation	0.0%	0.0 % V_{rated}	{0.1% V_{rated} }	+ 30 % V_{rated}	Reference: V_{rated} (C090)
C233*	V_p - V_{ab} controller	1.0	0.1 10	{0.1} {1.0}	10 50	Gain of the V_{ab} controller
[C234*]	T_n - V_{ab} controller	400 ms	20 ms	{10 ms}	2000 ms 9999 ms	$T_n = 9999$ ms: I-component switched-off (only when controller is inhibited)
[C235*]	Excitation characteristic	0	-0- -1-	internal excitation characteristic active internal excitation characteristic not active		With C253= -1-, the control process is based on operation with rated excitation
[C237*]	Synchronisation mode	0	-0- -1- -2- -3-	dyn. IMP, 20 ms correction no dyn. IMP, 20 ms correction dyn. IMP, 400 ms correction no dyn. IMP, 400 ms correction		
C240*	Window $n_{act} = n_{set}$	1%	0 % n_{max}	{0.1% n_{max} }	+ 100% n_{max}	Threshold for $n_{act} = n_{set}$, reference: n_{max}
C241	Window RFG on = RFG off	1%	0 % n_{max}	{0.1% n_{max} }	+ 100% n_{max}	Threshold ramp function generator input = ramp function generator output, reference: n_{max}
C242*	Threshold $ n_{act} > n_x$	1000 rpm	100 rpm	{1 rpm}	5000rpm	
C243*	Threshold $n_{set} > n_x$	1%	0 % n_{max}	{0.1 % n_{max} }	+ 100 % n_{max}	Threshold for $\leq C046 $ or $\leq C049 > n_x$, reference: n_{max}
C244*	Threshold $\leq A > I_x$	10%	0 % I_{Amax}	{0.1% I_{Amax} }	+ 100 % I_{Amax}	$\leq A > I_x$ Reference, rated controller current (armature)
C245*	Threshold $I_f > I_x$	10%	0 % I_{Fmax}	{0.1% I_{Fmax} }	+ 100% I_{Fmax}	$I_f > I_x$, Reference, rated controller current (field)
C249*	LECOM1 code bank	1	0	{1}	7	Fixed address offset: LECOM1 interface (protocol LECOM A/B) can address codes > 255.
C252*	Angle offset	0 inc	-245760000 inc	{1 inc}	245760000 inc	Fixed angle offset with digital frequency configurations (C005 = -5X-, -6X-, -72-) Format for LECOM: 0.022 (LECOM) correspond to 220 incr.
C253*	Angle offset	0 inc	-8190 inc	{1}	8190 inc	Speed-dependent angle offset Format for LECOM: 0.022 (LECOM) correspond to 220 incr.
C254*	V_p angle controller	0.33	0.00	{0.01}	1.00	Gain of the angle controller
C255*	Following error limit	220 inc	10 inc	{1 inc}	536750000 inc	Only active if C254 > 0! Format for LECOM: 0.022 (LECOM) correspond to 220 incr.
C256*	Angle trimming	0 inc	-32768 inc	{1 inc}	32767 inc	Angle offset with digital frequency configurations (C005 = -5X-, -6X- and -72-) Format for LECOM: 0.022 (LECOM) correspond to 220 incr. If an analog signal source (C145/C146) is assigned, the parameter will be displayed only.

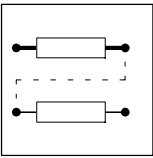

Configuration

Code	Name	Possible settings				Info
		Lenze	Selection			
C257*	Speed trimming	0 rpm	-5000 rpm	{1}	+5000 rpm	Fixed speed offset with digital frequency configurations (C005 = -5X-, -6X- and -72-). If an analog signal source (C145/C146) is assigned, the parameter will be displayed only.
C260*	Upper motor potentiometer limit	100%	-100.0 %	{0.1 %}	+100.0 %	C260 must be higher than C261!
C261*	Lower motor potentiometer limit	0 %	-100.0 %	{0.1%}	+100.0 %	C261 must be smaller than C260!
C262*	Motor pot. acceleration time	10 s	1 s	{1 s}	5000 s	C262 is activated if the motor potentiometer terminal is set to "UP" Reference: Change of 0... 100%
C263*	Motor pot. deceleration time	10 s	1 s	{1 s}	5000 s	C263 is activated if the motor potentiometer terminal is set to "DOWN" Reference: Change of 0... 100%
C264*	Motor potentiometer deactivation function	0	-0- -1- -2- -3- -4- -5-	No function, motor potentiometer is not changed. Down to 0%, motor potentiometer output runs with the corresponding acceleration or deceleration time to 0%. Down to lowest limit, motor potentiometer output runs with the corresponding acceleration or deceleration time to the value under C261. Jump to 0%, motor potentiometer output immediately changes to 0%. Jump to the lowest level, motor potentiometer immediately changes to the value indicated under C261. Up to the highest level, motor potentiometer output runs with the corresponding acceleration or deceleration to the value indicated under C260.		Function which is executed when deactivating the motor potentiometer (terminal DEACTIVE is set).
C265*	Initialisation function Sample & Hold	0	-0- -1-	Acceptance of the saved value S&H output accepts the value which was set before switching the mains. Lower limit, S&H output accepts the value of C261.		Function which is executed when switching on the mains.
C266*	Motor pot.: Operation via keypad		100.0 %	{0.1 %}	+100.0 %	Under C266, the motor potentiometer can also be operated with ▲ and ▼. Display: Output value of the motor potentiometer in % and exact value of control program.
C267*	Sample and Hold function	0	-0- -1-	S&H for motor potentiometer output S&H for FAI signal		
C270*	Analog/ digital conversion 1		-16384	{1}	16384	Display: Value assigned and digitized via C145 / C146 Output only via interfaces
C271*	Analog/ digital conversion 2		-16384	{1}	16384	Display: Value assigned and digitized via C145 / C146 Output only via interfaces
C272*	Digital/ analog conversion 1		-16384	{1}	16384	Input: Value for the conversion into an analog signal is to be entered via the monitor outputs X4/62, X4/63 or digital frequency output X8. Input only via interfaces.

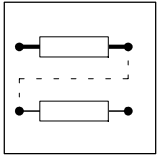

Code	Name	Possible settings				Info
		Lenze	Selection			
C273*	Digital/ analog conversion 2		-16384	{1}	16384	Input: Value for the conversion into an analog signal is to be entered via the monitor outputs X4/62, X4/63 or digital frequency output X8. Input only via interfaces.
C280*	Additional setpoint on/off	0	-0- -1-	Additional setpoint is on Additional setpoint is off		
C282*	Function for C047	0	-0- -1-	Function C047 = 100% - [input source] Function C047 = [input source]		
C285*	Limitation of rate of rise	40	1	{1}	1000	Limitation of rate of rise at the armature current controller input. Time: $-I_{Amax} t_0 + I_{Amax} = C285 \cdot t_{15}^{electr.}$
C286*	Upper limit of the speed setpoint	180%	-100.0 % -180 %	{0.1 %} {1 %}	+100.0 % +180 %	Upper limit of the speed setpoint for C050 C286 must be higher than C287!
C287*	Lower limit of the speed setpoint	-180%	-100.0 % -180 %	{0.1 %} {1 %}	+100.0 % +180 %	Upper limit of the speed setpoint for C050 C287 must be smaller than C286!
C310*	Speed dependent current limitation Limit value 1	100%	0.0 %	{0.1 %}	+100.0 %	Valid for speed under C313 C310 must be higher than C311!
C311*	Speed dependent current limitation Limit value 2	100%	0.0 %	{0.1 %}	+100.0 %	Valid for speed under C314 C311 must be smaller than C310!
C312*	n_0 Speed dependent current limitation	3000 rpm	0 rpm	{1 rpm}	5000 rpm	Act. speed threshold (current limitation), condition: $n_1 > n_0$
C313*	n_1 Speed dependent current limitation	4000 rpm	0 rpm	{1 rpm}	5000 rpm	Act. speed threshold for limit value 1 condition: $n_2 > n_1 > n_0$
C314*	n_2 Speed dependent current limitation	5000 rpm	0 rpm	{1 rpm}	5000 rpm	Act. speed threshold for limit value 2 condition: $n_2 > n_1 > n_0$
C316*	Reduced field current	20 %	0 % I_{Frated}	{1 % I_{Frated} }	100 % I_{Frated}	Reference: I_{Frated} (C083) With 0%, the pulses of the field controller are inhibited.
C317*	Time delay for the reduced field current	60 s	0.0 s 10 s 100 s	{0.1 s} {1 s} {10 s}	10 s 100 s 3600 s	Time which is required to activate the reduced field current after inhibiting the controller.
C318*	Activate field current reduction	0	-0- -1-	Field current reduction function is off Field current reduction function is on		
C319*	Actual V_p of the n- controller		1	{1}	1000	Display: Actual gain factor of the n-controller (important for n-controller adaption)

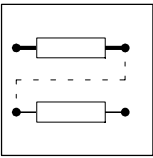

Configuration

Code	Name	Possible settings				Info
		Lenze	Selection			
C320*	V_{p2} of the n-controller adaption	8	1	{1}	1000	Second gain factor for speed controller adaption
C321*	V_{p3} of the n-controller adaption	8	1	{1}	1000	Third gain factor for speed controller adaption
C322*	n_1 of the n-controller adaption	3000 rpm	0 rpm	{1 rpm}	5000 rpm	Speed setpoint threshold of speed controller adaption, condition: $n_1 > n_0$
C323*	n_0 of the n-controller adaption	50 rpm	0 rpm	{1 rpm}	5000 rpm	Speed setpoint threshold of speed controller adaption, condition: $n_1 > n_0$
C324*	n-controller adaption on/off	0	-0- -1-	n-controller adaption is off n-controller adaption is on		
C325*	V_{p2} of the process controller adaption	1	0.1 10	{0.1} {1}	10 500	Second gain factor for process controller adaption
C326*	V_{p3} of the process controller adaption	1	0.1 10	{0.1} {1}	10 500	Third gain factor for process controller adaption
C327*	set2 of the process controller adaption	100 %	0.0 %	{0.1 %}	100.0 %	Setpoint speed threshold of the process controller adaption, condition: set2 > set1
C328*	set1 of the process controller adaption	0%	0.0 %	{0.1 %}	100.0 %	Setpoint speed threshold of the process controller adaption, condition: set2 > set1
C329*	Process controller adaption on/off	0	-0- -1-	Process controller adaption is off Process controller adaption is on		
C330*	Setpoint of the process controller	0%	-100.0 %	{0.1 %}	100.0 %	If an analog signal source (C145/C146) is assigned, the parameter will be displayed only.
C331*	Evaluation of the process ctrl. output	100 %	-100.0 %	{0.1%}	100.0 %	If an analog signal source (C145/C146) is assigned, the parameter will be displayed only.
C332*	Acceleration time T_{ir} of the process controller setpoint	0.00 s	0.00 s 1.0 s 10 s 100 s	{0.01 s} {0.1 s} {1 s} {10 s}	1.00 s 10.0 s 100 s 990 s	
C333*	Deceleration time T_{if} of the process ctrl. setpoint	0.00 s	0.00 s 1.0 s 10 s 100 s	{0.01 s} {0.1 s} {1 s} {10 s}	1.00 s 10.0 s 100 s 990 s	
C334*	Acceleration time T_{ir} of the process ctrl. evaluation	0.00 s	0.00 s 1.0 s 10 s 100 s	{0.01 s} {0.1 s} {1 s} {10 s}	1.00 s 10.0 s 100 s 990 s	
C335*	Deceleration time T_{if} of the process ctrl. evaluation	0.00 s	0.00 s 1.0 s 10 s 100 s	{0.01 s} {0.1 s} {1 s} {10 s}	1.00 s 10.0 s 100 s 990 s	

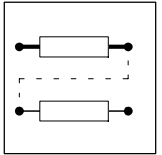

Code	Name	Possible settings				Info
		Lenze	Selection			
C336*	Actual V_p of the process controller		0.1	{0.1}	500.0	Display: Actual gain factor of the process controller (important for process controller adaption)
C338*	Input 1, arithmetic block 2	0%	-100.0 % -200 % {1 %}	{0.1 %} +200 %	100.0 %	If an analog signal source (C145/C146) is assigned, the parameter will be displayed only.
C339*	Input 2, arithmetic block 2	0%	-100.0 % -200 %	{0.1 %} {1 %}	100.0 % +200 %	If an analog signal source (C145/C146) is assigned, the parameter will be displayed only.
C370*	Enable automation interface		-0- No communication via automation interface -1- Communication via automation interface enabled			
C380*	n_{set} speed		-16384	{1}	16384	High precision main setpoint selection: 16384 100% under C046 Input only via interface.
C381*	n_{set} at n-controller		-32767	{1}	32767	High precision setpoint display: Input of the speed controller, 16384 100% under C050. Input only via interface.
C382*	Actual speed		-32767	{1}	32767	High precision display: Act. speed value 16384 n_{max} under C011. Input only via interface.
C387*	Torque limit		-16384	{1}	16384	High precision torque setpoint selection: 16384 100% under C047. Input only via interface.
C388*	Torque setpoint		-16384	{1}	16384	High precision torque setpoint display: 16384 100% under C056. Input only via interface.
C391*	Actual angle		0	{1}	65535	High precision display of the actual angle if resolver or incremental encoder operate as feedback system: 16384 360 1 revolution. Input only via interface.
C392*	Field current setpoint		0	{1}	16384	High precision display of the field current setpoint: 16384 I_{FN} under C083. Input only via interface.
C393*	Additional setpoint		-16384	{1}	16384	High precision additional setpoint display: 16384 100% under C049. Input only via interface.
C580*	Input 1, comparator 1	0 %	-100.0 % -200 %	{0.1 %} {1 %}	+100.0 % +200 %	If an analog signal source (C145/C146) is assigned, the parameter will be displayed only.
C581*	Input 2, limit value for comparator 1	0 %	-100.0 % -200 %	{0.1 %} {1 %}	+100.0 % +200 %	If an analog signal source (C145/C146) is assigned, the parameter will be displayed only.
C582*	Hysteresis for lower threshold comparator 1	0 %	0.0 %	{0.1 %}	+100.0 %	Lower threshold = C581 - C582, reference: C581
C583*	Memory function comparator 1		-0- Memory function not active when resetting the output, the value falls below the lower threshold (C581 - C582) -1- Memory function active The output remains set after initial switching on.			
C584*	Reset function comparator 1		-0- Reset function not active -1- Reset function active			The activation resets the output.

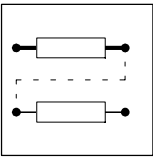

Configuration

Code	Name	Possible settings				Info
		Lenze	Selection			
C590*	Input 1, comparator 2	0 %	-100.0 % -200 %	{0.1 %} {1 %}	+100.0 % +200 %	If an analog signal source (C145/C146) is assigned, only the parameter will be displayed.
C591*	Input 2, limit value for comparator 2	0 %	-100.0 % -200 %	{0.1 %} {1 %}	+100.0 % +200 %	If an analog signal source (C145/C146) is assigned, only the parameter will be displayed.
C592*	Hysteresis for lower threshold comparator 2	0 %	0.0 %	{0.1 %}	+100.0 %	Lower threshold = C591 - C592, reference: C591
C593*	Memory function comparator 2		-0- Memory function not active when resetting the output, the value falls below the lower threshold (C591 - C592) -1- Memory function active The output remains set after initial switching on.			
C594*	Reset function comparator 2		-0- Reset function not active -1- Reset function active			The activation resets the output.
C600*	Arithmetic block 3	1	-0- Output = C601 -1- Output = C601 + C602 -2- Output = C601 - C602 -3- Output = C601 * C602 -4- Output = C601 / C602 -5- Output = C601 / (100% - C602)			
C601*	Input 1, arithmetic block 3	0%	-100.0 % -200 %	{0.1 %} {1 %}	100.0 % +200 %	If an analog signal source (C145/C146) is assigned, the parameter will be displayed only.
C602*	Input 2, arithmetic block 3	0%	-100.0 % -200 %	{0.1 %} {1%}	100.0 % +200 %	If an analog signal source (C145/C146) is assigned, the parameter will be displayed only.

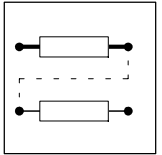

Code	Name	Possible settings				Info
		Lenze	Selection			
C610*	Input 1, addition block 1	0%	-100.0 % -200 %	{0.1 %} {1 %}	100.0 % +200 %	If an analog signal source (C145/C146) is assigned, the parameter will be displayed only.
C611*	Input 2, addition block 1	0%	-100.0 % -200 %	{0.1 %} {1 %}	100.0 % +200 %	If an analog signal source (C145/C146) is assigned, the parameter will be displayed only.
C612*	Input 3, addition block 1	0%	-100.0 % -200 %	{0.1 %} {1 %}	100.0 % +200 %	If an analog signal source (C145/C146) is assigned, the parameter will be displayed only.
C614*	Input 1, addition block 2	0%	-100.0 % -200 %	{0.1 %} {1 %}	100.0 % +200 %	If an analog signal source (C145/C146) is assigned, the parameter will be displayed only.
C615*	Input 2, addition block 2	0%	-100.0 % -200 %	{0.1 %} {1 %}	100.0 % +200 %	If an analog signal source (C145/C146) is assigned, the parameter will be displayed only.
C616*	Input 3, addition block 2	0%	-100.0 % -200 %	{0.1 %} {1 %}	100.0 % +200 %	If an analog signal source (C145/C146) is assigned, the parameter will be displayed only.
C620*	Gain dead band element	1.00	-10.00	{0.01}	+10.00	
C621*	Dead band, dead band element	1.0 %	0.0 %	{0.1 %}	100.0 %	
C622*	Input, dead band element	0%	-100.0 % -200 %	{0.1 %} {1 %}	100.0 % +200 %	Display parameter only
C630*	Limiting element 1 upper limit	100 %	-100.0 % -200 %	{0.1 %} {1 %}	100.0 % +200 %	C630 must be higher than C631!
C631*	Limiting element 1 lower limit	-100 %	-100.0 % -200 %	{0.1 %} {1 %}	100.0 % +200 %	C631 must be lower than C630!
C632*	Input, limiting element 1	0 %	-100.0 % -200 %	{0.1 %} {1 %}	100.0 % +200 %	Display parameter only
C635*	Limiting element 2 upper limit	100 %	-100.0 % -200 %	{0.1 %} {1 %}	100.0 % +200 %	C635 must be higher than C636!
C636*	Limiting element 2 lower limit	-100 %	-100.0 % -200 %	{0.1 %} {1 %}	100.0 % +200 %	C636 must be lower than C635!
C637*	Input, limiting element 2	0 %	-100.0 % -200 %	{0.1 %} {1 %}	100.0 % +200 %	Display parameter only
C640*	PT1 element Time constant	20ms	0.01 s 1 s 10 s	{0.01 s} {0.1 s} {1 s}	1 s 10 s 50 s	

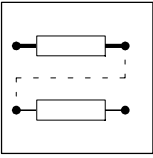

Configuration

Code	Name	Possible settings				Info
		Lenze	Selection			
C641*	Input, PT1 element	0 %	-100.0 % -200 %	{0.1 %} {1 %}	100.0 % +200 %	Display parameter only
C650*	Gain DT1 element	1.00	-10.00	{0.01}	+10.00	
C651*	DT1 element Time constant	1.0 s	0.01 s 1.0 s	{0.01 s} {0.1 s}	1.00 s 5.0 s	
C652*	Input, DT1 element	0 %	-100.0 % -200 %	{0.1 %} {1 %}	100.0 % +200 %	Display parameter only
C653*	Input sensitivity, DT1 element		-1- 15 bit evaluation -2- 14 bit evaluation -3- 13 bit evaluation -4- 12 bit evaluation -5- 11 bit evaluation -6- 10 bit evaluation -7- 9 bit evaluation			
C660*	Input, absolute value generator	0 %	-100.0 % -200 %	{0.1 %} {1 %}	100.0 % +200 %	Display parameter only
C670*	Square generator upper limit	0 %	-100.0 %	{0.1 %}	+100.0 %	C670 must be higher than C671!
C671*	Square generator lower limit	0 %	-100.0 %	{0.1%}	+100.0 %	C671 must be smaller than C670!
C672*	Switch-over time of the square generator	0.1 s	0.1 s 10 s 100 s	{0.1 s} {1 s} {10 s}	10.0 s 100 s 3000 s	

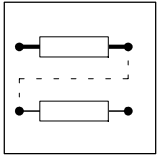

7.10 Table of attributes

The information given in this attribute table is required for generating a programme. It contains all information about the communication to the controller via parameters:

Column		Meaning	Entry	
Code		Name of the Lenze codes	Cxxx	
Index	dec	Index, under which the parameter is defined.	24575 – Lenze code number	Is only required for control via InterBus or PROFIBUS.
	hex	The subindex of array variables corresponds to the Lenze subcode number.	5FFh – Lenze code number	
Data	DS	Data structure	E	Simple variable (one parameter value)
			A	Array variable (several parameter elements can be selected through the code for input selection or via LECOM subcode)
			I	Image variable (several parameter elements can be selected through the code for input selection).
	DA	Number of array elements (Subcodes)	xx	
	DT	Data type	B8	1 byte bit coded
			B16	2 byte bit coded
			FIX32	32 bit value with sign; decimal with four decimal codes Example: 1.2 \triangle 12000 _{FIX32-dec} \triangle 00002E00 _{FIX32-hex} -10.45 \triangle -104500 _{FIX32-dec} \triangle FFFE67CC _{FIX32-hex}
			I16	2 byte with sign (-32768 ≤ X ≤ 32767)
			I32	4 byte with sign (-2147483648 ≤ X ≤ 2147483647)
			N16	16 bit value with sign 0% \triangle 0; 100% \triangle 2 ¹⁴ Example: 100% \triangle 16384 _{N16-dec} \triangle 4000 _{N16-hex} -50% \triangle -8192 _{N16-dec} \triangle E000 _{N16-hex}
			U16	2 byte without sign (0 ≤ X ≤ 65535)
			VS	ASCII string
			VD	ASCII decimal format
			VH	ASCII hexadecimal format
VS			String format	
format	LECOM format (see Operating Instructions for fieldbus modules)			
DL	Data length in byte			
Access	P/S	Parameter setting / control (according to C001)	P	Parameter setting
			S	Control
	LCM-R/W	Access authorization for LECOM	Ra	Reading is always permitted
			Wa	Writing is always permitted
			W	Writing depends on condition
AIF	Proceß datum in automation interface Mapping to LECOM2 process data channel possible	PZD	Process datum	

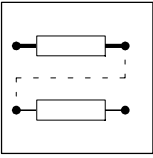

Configuration

Code	Index dec	hex	Data					Access		
			DS	DA	DT	Format	DL	S/P	LCM-R/ W	AIF-PZD
C000	24575	5FFFh	E	1	FIX32	VD	4	P	Ra	-
C001	24574	5FFEh	E	1	FIX32	VD	4	-	Ra/Wa	-
C002	24573	5FFDh	E	1	FIX32	VD	4	P	Ra/W	-
C003	24572	5FFCh	E	1	FIX32	VD	4	P	Ra/W	-
C004	24571	5FFBh	E	1	FIX32	VD	4	P	Ra/W	-
C005	24570	5FFAh	E	1	FIX32	VD	4	P	Ra/W	-
C009	24566	5FF6h	E	1	FIX32	VD	4	P	Ra/W	-
C011	24564	5FF4h	E	1	FIX32	VD	4	P	Ra/W	-
C012	24563	5FF3h	E	1	FIX32	VD	4	P	Ra/W	-
C013	24562	5FF2h	E	1	FIX32	VD	4	P	Ra/W	-
C017	24558	5FEEh	E	1	FIX32	VD	4	P	Ra/W	-
C019	24556	5FEC	E	1	FIX32	VD	4	P	Ra/W	-
C022	24553	5FE9h	E	1	FIX32	VD	4	P	Ra/W	-
C023	24552	5FE8h	E	1	FIX32	VD	4	P	Ra/W	-
C025	24550	5FE6h	E	1	FIX32	VD	4	P	Ra/W	-
C026	24549	5FE5h	I	1	FIX32	VD	4	P	Ra/W	-
C027	24548	5FE4h	I	1	FIX32	VD	4	P	Ra/W	-
C028	24547	5FE3h	I	1	FIX32	VD	4	P	Ra/W	-
C029	24546	5FE2h	I	1	FIX32	VD	4	P	Ra/W	-
C030	24545	5FE1h	E	1	FIX32	VD	4	P	Ra/W	-
C032	24543	5FDFh	E	1	FIX32	VD	4	P	Ra/W	-
C033	24542	5FDEh	E	1	FIX32	VD	4	P	Ra/W	-
C034	24541	5FDDh	E	1	FIX32	VD	4	P	Ra/W	-
C038	24537	5FD9h	E	1	FIX32	VD	4	P	Ra/W	-
C039	24536	5FD8h	A	15	FIX32	VD	4	P	Ra/W	-
C040	24535	5FD7h	E	1	FIX32	VD	4	S	Ra/W	-
C041	24534	5FD6h	E	1	FIX32	VD	4	S	Ra/W	-
C042	24533	5FD5h	E	1	FIX32	VD	4	S	Ra/W	-
C043	24532	5FD4h	E	1	FIX32	VD	4	P	Ra/W	-
C045	24530	5FD2h	E	1	FIX32	VD	4	S	Ra/W	-
C046	24529	5FD1h	E	1	FIX32	VD	4	S	Ra/W	-
C047	24528	5FD0h	E	1	FIX32	VD	4	S	Ra/W	-
C049	24526	5FCEh	E	1	FIX32	VD	4	S	Ra	-
C050	24525	5FCDh	E	1	FIX32	VD	4	S	Ra	-
C051	24524	5FCC	E	1	FIX32	VD	4	S	Ra	-
C052	24523	5FCBh	E	1	FIX32	VD	4	S	Ra	-
C054	24521	5FC9h	E	1	FIX32	VD	4	S	Ra	-
C056	24519	5FC7h	E	1	FIX32	VD	4	S	Ra	-
C060	24515	5FC3h	E	1	FIX32	VD	4	S	Ra	-
C061	24514	5FC2h	E	1	FIX32	VD	4	S	Ra	-
C063	24512	5FC0h	E	1	FIX32	VD	4	S	Ra/W	-
C065	24510	5FBEh	E	1	FIX32	VD	4	P	Ra	-
C066	24509	5FBDh	E	1	FIX32	VD	4	P	Ra	-
C067	24508	5FBCh	E	1	FIX32	VD	4	P	Ra	-
C068	24507	5FBBh	E	1	B16	VH	2	S	Ra	-
C069	24506	5FBAh	E	1	B8	VH	1	S	Ra	-
C070	24505	5FB9h	E	1	FIX32	VD	4	P	Ra/W	-
C071	24504	5FB8h	E	1	FIX32	VD	4	P	Ra/W	-
C072	24503	5FB7h	E	1	FIX32	VD	4	P	Ra/W	-
C075	24500	5FB4h	E	1	FIX32	VD	4	P	Ra/W	-
C076	24499	5FB3h	E	1	FIX32	VD	4	P	Ra/W	-
C077	24498	5FB2h	E	1	FIX32	VD	4	P	Ra/W	-
C078	24497	5FB1h	E	1	FIX32	VD	4	P	Ra/W	-
C079	24496	5FB0h	E	1	FIX32	VD	4	P	Ra/W	-
C081	24494	5FAEh	E	1	FIX32	VD	4	P	Ra/W	-
C082	24493	5FADh	E	1	FIX32	VD	4	P	Ra/W	-
C083	24492	5FACH	E	1	FIX32	VD	4	P	Ra/W	-
C084	24491	5FABh	E	1	FIX32	VD	4	P	Ra/W	-

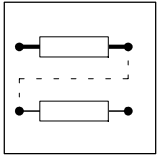

Code	Index		Data					Access		
	dec	hex	DS	DA	DT	Format	DL	S/P	LCM-R/W	AIF-PZD
C085	24490	5FAAh	E	1	FIX32	VD	4	P	Ra/W	-
C087	24488	5FA8h	E	1	FIX32	VD	4	P	Ra/W	-
C088	24487	5FA7h	E	1	FIX32	VD	4	P	Ra/W	-
C090	24485	5FA5h	E	1	FIX32	VD	4	P	Ra/W	-
C093	24482	5FA2h	E	1	FIX32	VD	4	P	Ra	-
C094	24481	5FA1h	E	1	FIX32	VD	4	P	Ra/W	-
C096	24479	5F9Fh	E	1	FIX32	VD	4	P	Ra/W	-
C097	24478	5F9Eh	E	1	FIX32	VD	4	P	Ra/W	-
C098	24477	5F9Dh	E	1	FIX32	VD	4	P	Ra/W	-
C099	24476	5F9Ch	E	1	VS	VS	6	P	Ra	-
C100	24475	5F9Bh	E	1	FIX32	VD	4	P	Ra/W	-
C101	24474	5F9Ah	A	15	FIX32	VD	4	P	Ra/W	-
C103	24472	5F98h	A	15	FIX32	VD	4	P	Ra/W	-
C105	24470	5F96h	E	1	FIX32	VD	4	P	Ra/W	-
C108	24467	5F93h	A	3	FIX32	VD	4	P	Ra/W	-
C109	24466	5F92h	A	2	FIX32	VD	4	P	Ra/W	-
C110	24465	5F91h	E	1	FIX32	VD	4	P	Ra/W	-
C111	24464	5F90h	A	3	FIX32	VD	4	P	Ra/W	-
C112	24463	5F8Fh	E	1	FIX32	VD	4	P	Ra/W	-
C113	24462	5F8Eh	A	5	FIX32	VD	4	P	Ra/W	-
C114	24461	5F8Dh	A	5	FIX32	VD	4	P	Ra/W	-
C115	24460	5F8Ch	A	5	FIX32	VD	4	P	Ra/W	-
C116	24459	5F8Bh	E	1	FIX32	VD	4	P	Ra/W	-
C117	24458	5F8Ah	A	13	FIX32	VD	4	P	Ra/W	-
C118	24457	5F89h	A	13	FIX32	VD	4	P	Ra/W	-
C119	24456	5F88h	E	1	FIX32	VD	4	P	Ra/W	-
C120	24455	5F87h	A	23	FIX32	VD	4	P	Ra/W	-
C123	24452	5F84h	E	1	FIX32	VD	4	P	Ra/W	-
C124	24451	5F83h	E	1	FIX32	VD	4	P	Ra/W	-
C125	24450	5F82h	E	1	FIX32	VD	4	P	Ra/W	-
C126	24449	5F81h	E	1	FIX32	VD	4	P	Ra/W	-
C128	24447	5F7Fh	A	13	FIX32	VD	4	P	Ra/W	-
C130	24445	5F7Dh	E	1	FIX32	VD	4	P	Ra/W	-
C131	24444	5F7Ch	E	1	FIX32	VD	4	P	Ra/W	-
C132	24443	5F7Bh	E	1	FIX32	VD	4	P	Ra/W	-
C134	24441	5F79h	E	1	FIX32	VD	4	P	Ra/W	-
C136	24439	5F77h	E	1	B16	VH	2	S	Ra	PZD
C145	24430	5F6Eh	E	1	FIX32	VD	4	P	Ra/W	-
C146	24429	5F6Dh	A	43	FIX32	VD	4	P	Ra/W	-
C147	24428	5F6Ch	A	7	FIX32	VD	4	P	Ra/W	-
C148	24427	5F6Bh	E	1	FIX32	VD	4	S	Ra/W	-
C149	24426	5F6Ah	E	1	FIX32	VD	4	S	Ra/W	-
C151	24424	5F68h	E	1	B16	VH	2	S	Ra	PZD
C161	24414	5F5Eh	E	1	FIX32	VD	4	S	Ra	-
C162	24413	5F5Dh	E	1	FIX32	VD	4	S	Ra	-
C163	24412	5F5Ch	E	1	FIX32	VD	4	S	Ra	-
C164	24411	5F5Bh	E	1	FIX32	VD	4	S	Ra	-
C165	24410	5F5Ah	E	1	FIX32	VD	4	S	Ra	-
C166	24409	5F59h	E	1	FIX32	VD	4	S	Ra	-
C167	24408	5F58h	E	1	FIX32	VD	4	S	Ra	-
C168	24407	5F57h	E	1	FIX32	VD	4	S	Ra	-
C180	24395	5F4Bh	E	1	FIX32	VD	4	P	Ra/W	-
C182	24393	5F49h	E	1	FIX32	VD	4	P	Ra/W	-
C183	24392	5F48h	E	1	VS	VS	16	S	Ra	-
C185	24390	5F46h	E	1	FIX32	VD	4	S	Ra	-
C186	24389	5F45h	E	1	FIX32	VD	4	S	Ra	-
C187	24388	5F44h	E	1	FIX32	VD	4	S	Ra/W	-
C188	24387	5F43h	E	1	FIX32	VD	4	S	Ra/W	-

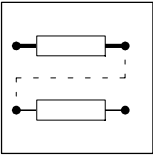

Configuration

Code	Index dec	hex	Data					Access		
			DS	DA	DT	Format	DL	S/P	LCM-R/ W	AIF-PZD
C189	24386	5F42h	E	1	FIX32	VD	4	S	Ra	-
C190	24385	5F41h	E	1	FIX32	VD	4	P	Ra/W	-
C191	24384	5F40h	E	1	FIX32	VD	4	P	Ra/W	-
C192	24383	5F3Fh	E	1	FIX32	VD	4	P	Ra/W	-
C193	24382	5F3Eh	A	15	FIX32	VD	4	P	Ra/W	-
C194	24381	5F3Dh	E	1	FIX32	VD	4	P	Ra/W	-
C195	24380	5F3Ch	E	1	FIX32	VD	4	P	Ra/W	-
C196	24379	5F3Bh	E	1	FIX32	VD	4	P	Ra/W	-
C197	24378	5F3Ah	E	1	FIX32	VD	4	P	Ra/W	-
C198	24377	5F39h	E	1	FIX32	VD	4	P	Ra/W	-
C199	24376	5F38h	E	1	FIX32	VD	4	P	Ra/W	-
C200	24375	5F37h	E	1	VS	VS	14	P	Ra	-
C201	24374	5F36h	E	1	VS	VS	20	P	Ra	-
C220	24355	5F23h	E	1	FIX32	VD	4	P	Ra/W	-
C221	24354	5F22h	E	1	FIX32	VD	4	P	Ra/W	-
C222	24353	5F21h	E	1	FIX32	VD	4	P	Ra/W	-
C223	24352	5F20h	E	1	FIX32	VD	4	P	Ra/W	-
C224	24351	5F1Fh	E	1	FIX32	VD	4	P	Ra/W	-
C230	24345	5F19h	E	1	FIX32	VD	4	P	Ra/W	-
C231	24344	5F18h	E	1	FIX32	VD	4	P	Ra/W	-
C232	24343	5F17h	E	1	FIX32	VD	4	P	Ra/W	-
C233	24342	5F16h	E	1	FIX32	VD	4	P	Ra/W	-
C234	24341	5F15h	E	1	FIX32	VD	4	P	Ra/W	-
C235	24340	5F14h	E	1	FIX32	VD	4	P	Ra/W	-
C237	24338	5F12h	E	1	FIX32	VD	4	P	Ra/W	-
C240	24335	5F0Fh	E	1	FIX32	VD	4	P	Ra/W	-
C241	24334	5F0Eh	E	1	FIX32	VD	4	P	Ra/W	-
C242	24333	5F0Dh	E	1	FIX32	VD	4	P	Ra/W	-
C243	24332	5F0Ch	E	1	FIX32	VD	4	P	Ra/W	-
C244	24331	5F0Bh	E	1	FIX32	VD	4	P	Ra/W	-
C245	24330	5F0Ah	E	1	FIX32	VD	4	P	Ra/W	-
C249	24326	5F06h	E	1	FIX32	VD	4	P	Ra/W	-
C252	24323	5F03h	E	1	FIX32	VD	4	P	Ra/W	-
C253	24322	5F02h	E	1	FIX32	VD	4	P	Ra/W	-
C254	24321	5F01h	E	1	FIX32	VD	4	P	Ra/W	-
C255	24320	5F00h	E	1	FIX32	VD	4	P	Ra/W	-
C256	24319	5EFFh	E	1	FIX32	VD	4	P	Ra/W	-
C257	24318	5EFEh	E	1	FIX32	VD	4	P	Ra/W	-
C260	24315	5EFBh	E	1	FIX32	VD	4	P	Ra/W	-
C261	24314	5EFAh	E	1	FIX32	VD	4	P	Ra/W	-
C262	24313	5EF9h	E	1	FIX32	VD	4	P	Ra/W	-
C263	24312	5EF8h	E	1	FIX32	VD	4	P	Ra/W	-
C264	24311	5EF7h	E	1	FIX32	VD	4	P	Ra/W	-
C265	24310	5EF6h	E	1	FIX32	VD	4	P	Ra/W	-
C266	24309	5EF5h	E	1	FIX32	VD	4	S	Ra	-
C267	24308	5EF4h	E	1	FIX32	VD	4	P	Ra/W	-
C270	24305	5EF1h	E	1	I16	VH	2	S	Ra	-
C271	24304	5EF0h	E	1	I16	VH	2	S	Ra	-
C272	24303	5EEFh	E	1	I32	VH	4	P	Ra/W	-
C273	24302	5EEEh	E	1	I32	VH	4	P	Ra/W	-
C280	24295	5EE7h	E	1	FIX32	VD	4	P	Ra/W	-
C281	24294	5EE6h	E	1	VS	VS	16	P	Ra	-
C282	24293	5EE5h	E	1	FIX32	VD	4	P	Ra/W	-
C285	24290	5EE2h	E	1	FIX32	VD	4	P	Ra/W	-
C286	24289	5EE1h	E	1	FIX32	VD	4	P	Ra/W	-
C287	24288	5EE0h	E	1	FIX32	VD	4	P	Ra/W	-
C300	24275	5ED3h	E	1	FIX32	VD	4	S	Ra	-
C310	24265	5EC9h	E	1	FIX32	VD	4	P	Ra/W	-

Configuration

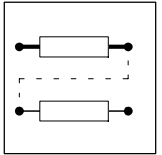

Code	Index		Data					Access		
	dec	hex	DS	DA	DT	Format	DL	S/P	LCM-R/W	AIF-PZD
C311	24264	5EC8h	E	1	FIX32	VD	4	P	Ra/W	-
C312	24263	5EC7h	E	1	FIX32	VD	4	P	Ra/W	-
C313	24262	5EC6h	E	1	FIX32	VD	4	P	Ra/W	-
C314	24261	5EC5h	E	1	FIX32	VD	4	P	Ra/W	-
C316	24259	5EC3h	E	1	FIX32	VD	4	P	Ra/W	-
C317	24258	5EC2h	E	1	FIX32	VD	4	P	Ra/W	-
C318	24257	5EC1h	E	1	FIX32	VD	4	P	Ra/W	-
C319	24256	5EC0h	E	1	FIX32	VD	4	S	Ra	-
C320	24255	5EBFh	E	1	FIX32	VD	4	P	Ra/W	-
C321	24254	5EBEh	E	1	FIX32	VD	4	P	Ra/W	-
C322	24253	5EBDh	E	1	FIX32	VD	4	P	Ra/W	-
C323	24252	5EBCh	E	1	FIX32	VD	4	P	Ra/W	-
C324	24251	5EBBh	E	1	FIX32	VD	4	P	Ra/W	-
C325	24250	5EBAh	E	1	FIX32	VD	4	P	Ra/W	-
C326	24249	5EB9h	E	1	FIX32	VD	4	P	Ra/W	-
C327	24248	5EB8h	E	1	FIX32	VD	4	P	Ra/W	-
C328	24247	5EB7h	E	1	FIX32	VD	4	P	Ra/W	-
C329	24246	5EB6h	E	1	FIX32	VD	4	P	Ra/W	-
C330	24245	5EB5h	E	1	FIX32	VD	4	P	Ra/W	-
C331	24244	5EB4h	E	1	FIX32	VD	4	P	Ra/W	-
C332	24243	5EB3h	E	1	FIX32	VD	4	P	Ra/W	-
C333	24242	5EB2h	E	1	FIX32	VD	4	P	Ra/W	-
C334	24241	5EB1h	E	1	FIX32	VD	4	P	Ra/W	-
C335	24240	5EB0h	E	1	FIX32	VD	4	P	Ra/W	-
C336	24239	5EAFh	E	1	FIX32	VD	4	S	Ra	-
C338	24237	5EADh	E	1	FIX32	VD	4	P	Ra/W	-
C339	24236	5EACH	E	1	FIX32	VD	4	P	Ra/W	-
C370	24205	5E8Dh	E	1	FIX32	VD	4	P	Ra/W	-
C380	24195	5E83h	E	1	N16	VH	2	P	Ra/W	PZD
C381	24194	5E82h	E	1	I16	VH	2	P	Ra	-
C382	24193	5E81h	E	1	I16	VH	2	P	Ra	PZD
C387	24188	5E7Ch	E	1	I16	VH	2	P	Ra/W	PZD
C388	24187	5E7Bh	E	1	I16	VH	2	P	Ra	PZD
C391	24184	5E78h	E	1	U16	VH	2	P	Ra	PZD
C392	24183	5E77h	E	1	N16	VH	2	P	Ra	PZD
C393	24182	5E76h	E	1	N16	VH	2	P	Ra	PZD
C580	23995	5DBBh	E	1	FIX32	VD	4	P	Ra/W	-
C581	23994	5DBAh	E	1	FIX32	VD	4	P	Ra/W	-
C582	23993	5DB9h	E	1	FIX32	VD	4	P	Ra/W	-
C583	23992	5DB8h	E	1	FIX32	VD	4	P	Ra/W	-
C584	23991	5DB7h	E	1	FIX32	VD	4	P	Ra/W	-
C590	23985	5DB1h	E	1	FIX32	VD	4	P	Ra/W	-
C591	23984	5DB0h	E	1	FIX32	VD	4	P	Ra/W	-
C592	23983	5DAFh	E	1	FIX32	VD	4	P	Ra/W	-
C593	23982	5DAEh	E	1	FIX32	VD	4	P	Ra/W	-
C594	23981	5DADh	E	1	FIX32	VD	4	P	Ra/W	-
C600	23975	5DA7h	E	1	FIX32	VD	4	P	Ra/W	-
C601	23974	5DA6h	E	1	FIX32	VD	4	P	Ra/W	-
C602	23973	5DA5h	E	1	FIX32	VD	4	P	Ra/W	-
C610	23965	5D9Dh	E	1	FIX32	VD	4	P	Ra/W	-
C611	23964	5D9Ch	E	1	FIX32	VD	4	P	Ra/W	-
C612	23963	5D9Bh	E	1	FIX32	VD	4	P	Ra/W	-
C614	23961	5D99h	E	1	FIX32	VD	4	P	Ra/W	-
C615	23960	5D98h	E	1	FIX32	VD	4	P	Ra/W	-
C616	23959	5D97h	E	1	FIX32	VD	4	P	Ra/W	-
C620	23955	5D93h	E	1	FIX32	VD	4	P	Ra/W	-
C621	23954	5D92h	E	1	FIX32	VD	4	P	Ra/W	-
C622	23953	5D91h	E	1	FIX32	VD	4	S	Ra	-

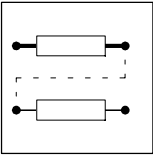

Configuration

Code	Index		Data					Access		
	dec	hex	DS	DA	DT	Format	DL	S/P	LCM-R/W	AIF-PZD
C630	23945	5D89h	E	1	FIX32	VD	4	P	Ra/W	-
C631	23944	5D88h	E	1	FIX32	VD	4	P	Ra/W	-
C632	23943	5D87h	E	1	FIX32	VD	4	S	Ra	-
C635	23940	5D84h	E	1	FIX32	VD	4	P	Ra/W	-
C636	23939	5D83h	E	1	FIX32	VD	4	P	Ra/W	-
C637	23938	5D82h	E	1	FIX32	VD	4	S	Ra	-
C640	23935	5D7Fh	E	1	FIX32	VD	4	P	Ra/W	-
C641	23934	5D7Eh	E	1	FIX32	VD	4	S	Ra	-
C650	23925	5D75h	E	1	FIX32	VD	4	P	Ra/W	-
C651	23924	5D74h	E	1	FIX32	VD	4	P	Ra/W	-
C652	23923	5D73h	E	1	FIX32	VD	4	S	Ra	-
C653	23922	5D72h	E	1	FIX32	VD	4	P	Ra/W	-
C660	23915	5D6Bh	E	1	FIX32	VD	4	S	Ra	-
C670	23905	5D61h	E	1	FIX32	VD	4	P	Ra/W	-
C671	23904	5D60h	E	1	FIX32	VD	4	P	Ra/W	-
C672	23903	5D5Fh	E	1	FIX32	VD	4	P	Ra/W	-

Configuration

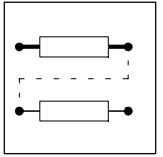

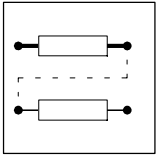

Configuration

EDS4900U--E
00408854

Manual

Part E

***Troubleshooting and
fault elimination***

Maintenance

***DC speed controller
4800/4900***

The features, data and versions indicated in this Manual met the state of the art at the time of printing.

(Printing date: inner cover pages of the parts).

In the event of deviations, please see the Operating Instructions or contact Lenze.

		revised	
Edition of:	01/03/1999		



8 Troubleshooting and fault elimination



Warning!

During troubleshooting, the drive should always be disconnected from the mains supply for safety reasons.

The controller is equipped with several functions to protect it from impermissible operating conditions. If one of the protection functions is activated, the controller sets Pulse Inhibit (IMP) or TRIP, warning or message and/or resets the signal "Ready for operation (RDY) - depending on the monitoring selected.

- Faults during operation are immediately displayed or indicated through a status information (chapter 8.1).
- The fault can be analysed with the history buffer (chapter 8.2) and the list in chapter 8.3.
- The list in chapter 8.3 indicates how to eliminate the fault.

8.1 Troubleshooting

8.1.1 Display on the operating unit of the controller

The LEDs RDY and IMP show the controller status.

FAIL = ■ : TRIP or message or warning is active

FAIL	RDY	IMP	Check
<input type="checkbox"/>	<input checked="" type="checkbox"/>	<input type="checkbox"/>	Controller enabled; no fault
<input checked="" type="checkbox"/>	<input type="checkbox"/>	<input checked="" type="checkbox"/>	C065, C066, C067
<input type="checkbox"/>	<input type="checkbox"/>	<input checked="" type="checkbox"/>	C183, C067
<input type="checkbox"/>	<input checked="" type="checkbox"/>	<input checked="" type="checkbox"/>	C183
<input checked="" type="checkbox"/>	<input checked="" type="checkbox"/>	<input type="checkbox"/>	C065, C066
<input checked="" type="checkbox"/>	<input checked="" type="checkbox"/>	<input checked="" type="checkbox"/>	C065, C066, C067, C183

■ : on □ : off



Troubleshooting and fault elimination

RDY

In general, the RDY message will be reset if the machine cannot generate a torque when running with the command "Controller enable" or if the mains supply for the control electronics is switched-off (mains switch-off detection).

RDY is off when

- TRIP is displayed
- the communication with the automation module could not be established after mains connection (only with C370 = -1-)
- the field current could not be built up after mains connection.

RDY will be reset for a short period of time when

- a new parameter set is loaded via terminal control
- a short-term mains fault (3-phases) occurs (> 25ms).

I_{\max}

I_{\max} is on when

- the speed controller operates at its limit.

IMP

IMP is on when

- the switch Ctrl. enable is opened or another source of the controller inhibit is active (check C183)
- a mains undervoltage or mains overvoltage is applied.

IMP is on sporadically when

- short-term mains faults occur (e.g. with weak mains)

During IMP, the ignition pulses in the armature circuit are inhibited.

The codes C065, C066 and C067 display the controller status in plain text.

8.1.2 Display via LECOM

The bits of the status word under C069 indicate the controller status (chapter 12.3).



8.2 Fault analysis with the history buffer

With the history buffer, faults can be traced. The fault messages are stored in the history buffer in the order of their occurrence.

8.2.1 Structure of the history buffer

- The history buffer has eight memory locations, which can be retrieved
 - under C065, C066 and C067 at the operating unit
 - via the LECOM interface under codes C161 to C168 for TRIP messages.
- The first memory location is written only after the elimination or acknowledgement of the active fault. The eighth from last fault is eliminated in the history buffer and can no longer be read.
- The memory locations 1-8 contain information about the last to eighth from last fault.

Code	C0168
C063	Active message
C066	Active warning
C067	Active TRIP
C161	Memory location 1
C162	Memory location 2
C163	Memory location 3
C164	Memory location 4
C165	Memory location 5
C166	Memory location 6
C167	Memory location 7
C168	Memory location 8



Troubleshooting and fault elimination

8.3 Fault messages



Note!

If the fault message is interrogated by a fieldbus, the fault message is represented not by an abbreviation but a LECOM no. read from C167.

Display		Cause	Remedy
---	No fault	-	-
ACI	Armature circuit interrupted	Defective fuse in the armature circuit or cable interruption	Check armature fuse or remove cable interruption
CCr	System fault	Strong interference on control cables Ground or earth loops in the wiring	Screen control cables Check PE wiring (see chapter 4.4 "Installation of a CE-typical drive system")
CE0	Communication fault (automation interface)	Interference during transmission of control commands via the automation interface	Check wiring
CE9	Communication fault (serial interface)	Faulty messages from the serial interface.	Check wiring
dEr	Motor blocked	High standstill torque or motor mechanically blocked.	Remove motor blockage or increase blocking time under C124 or blocking current under C123.
EEr	External fault (TRIP-Set)	A digital input assigned to the TRIP-Set function has been activated	Check external encoder. Check polarity to activate TRIP set under C118.
FCI	Field circuit interrupted	Defective field fuses F1 and F2 or interrupted field circuit.	Replace field fuses when no voltage is applied or remove cable interruption.
LF	Mains underfrequency	Mains frequency < 47Hz	Check mains frequency, controller must only be driven within a frequency range from 47 to 63 Hz.
LU	Undervoltage	Mains voltage < 340 V or 410 V (Variant 500 V mains voltage) Mains synchronisation has not detected any voltage zero for more than 25 ms.	Increase electronics supply separately with a connected transformer or use a controller with a lower mains connection voltage.
LU1	Phase failure	Failure of the mains voltage or mains interruption	Check mains voltage and remove mains interruption Adapt mains synchronisation to mains conditions under C237.
OC5	Controller overload	Frequent or excessive acceleration with overcurrent Permanent overload with $I_A > 1.05 I_{Arated}$	Check drive dimensioning
OC6	Motor is thermally overloaded	Motor is thermally overloaded by, for instance, - impermissibly high continuous currents - frequent and excessive acceleration processes	Check drive dimensioning
OF	Mains overfrequency	Mains frequency > 63Hz	Check mains frequency Controller must only be driven within a frequency range from 47 to 63 Hz.
OH	Heat sink temperature is higher than the value set in the controller	Ambient temperature $T_{amb} > 45 \text{ }^\circ\text{C}$ or $35 \text{ }^\circ\text{C}$ Heat sink very dirty Incorrect mounting position	Allow controller to cool and ensure better ventilation Check ambient temperature in the control cabinet Clean heat sink Change mounting position



Display		Cause	Remedy
OUE	Mains overvoltage	Mains voltage > 460V or 550V (500V variant)	Reduce mains voltage with a preconnected transformer or use a controller with a higher mains connection voltage.
P03	Following error	Angle difference between set and actual position is larger than the following error limit set under C255 Drive cannot follow the digital frequency (I_{max} limit)	Extend following limit with C255 Switch-off monitoring if required (C119/C120) Enable drive (Ctrl. enable) Check drive dimensioning
P13	Angle overflow	Angle controller limit reached Drive cannot follow the digital frequency (I_{max} limit)	Enable drive Check drive dimensioning
PER	Program interference	A fault in the program sequence was detected	Send controller with data (on diskette) to Lenze
PR	Parameter reset	After switching on, a change in the software version has been detected. Automatic loading of factory setting.	Set the required parameters and save settings under C003.
PR1 ... PR4	Parameter set error	Fault when reading a parameter set CAUTION: The factory setting is loaded automatically	Set the required parameters and save settings under C003.
Sd1	Tacho fault	Short circuit or interruption of tacho cable	Check tacho cables for short-circuit or interruption and remove fault
Sd2	Resolver fault	Resolver cable interrupted	Check resolver cable for open circuit Check resolver Acknowledge fault by mains switching
Sd3	Encoder fault at Dig_In 1	Incremental encoder or digital frequency cable interrupted at X5 Input X5 PIN 8 not assigned	Check cable for open circuit Assign input X5 PIN 8 with encoder potential or switch off monitoring (C119 / C120)
Sd4	Encoder fault at Dig_In 2	Incremental encoder or digital frequency cable interrupted at X9 Input X9 PIN 8 not assigned	Assign input X9 PIN 8 with encoder potential or switch off monitoring (C119 / C120)
Sd5	Master current interrupted	Interruption of the master current selection, $I_{master} < 2\text{mA}$ with master current selection 4...20mA, C034 = -1-	Remove interruption of the set-value cable or select master selection 0...20 mA under C034 = -0-
SP	Wrong signal source polarity	Tacho, resolver or fieldbus connection are interchanged	Change tacho, resolver or fieldbus connection
U15	15V supply interfered	Overload / short-circuit terminal 20 15 V supply defective	Check load at terminal 20 Return controller



8.4 Reset of fault indications

TRIP

After eliminating the fault, pulse inhibit will only be reset after the acknowledgement of TRIP.

TRIP acknowledgement:

- Change to the parameter level of C067 and acknowledge with SH+PRG
- LECOM: C043 = 0
- Terminal X2/E2 (reset trip)
- Control word AIF
- Mains switching



Note!

If a TRIP source is still active, TRIP cannot be reset.

Message

After eliminating the fault, the pulse inhibit will be reset automatically.



8.5 Checking the drive system



Note!

The measurements should be made with a digital voltmeter. The stated measuring values are rated values. In the event of deviations, a defect has occurred.

8.5.1 Checking the motor



Warning!

- The measurements described must only be carried out by specialists.
- Disconnect the motor from the mains.
- Tests should only be carried out when no voltage is applied!

Measurement	Measuring point	Measured value
Armature resistance	A B at the controller	$R_A < 10$
Insulation resistance of the armature	A earth potential	R
	B earth potential	R
Field resistance	I K	$R_F < 1k$
Insulation resistance of the field	I earth potential	R
	K earth potential	R



Troubleshooting and fault elimination

8.5.2 Checking the controller

Checking the power stage



Warning!

- The measurements described must only be carried out by specialists.
- Disconnect the controller from the mains.
- Tests should only be carried out when no voltage is applied!

Measurement	Measuring point	Measuring value
Semiconductor fuse • at the mains input • armature fuse		R 0 R 0
Internal fuses		R 0
Thyristors	Disconnect armature cables: A B at the controller B A at the controller	R R
Field controller	Disconnect field cables: I+, K- I-, K+ (free-wheeling diode)	R R > 200k (diode 0.5V)

Checking the control board 4902MP

Checking the voltage supply:

- Wire up the controller completely
- Set controller inhibit (X2/28 open)
- Switch on the mains

Notes	Measuring point	Measured value
+Vcc 15 V	X2/20 X3/40	+ 14.25 V...+ 15.75 V
+Vref 10 V	X1/9 X3/40	+ 9.79 V...+ 10.21 V
-Vref 10 V	X1/10 X3/40	-9.79 V... -10.21 V

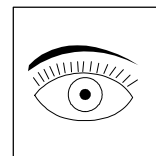

9 Maintenance

9.1 Maintenance

- The controller is free of maintenance if the prescribed operating conditions are maintained (see chapter 3.2).
- If the ambient air is polluted, the air vents of the controller may be obstructed.
 - Check the air vents periodically (depending on the degree of pollution):
 - Free the obstructed air vents using a vacuum cleaner.



Stop!

Do not use sharp or pointed objects, such as knives or screw drivers to clean the air vents.

9.2 Service addresses

The addresses of the Lenze representatives all over the world are listed on the last page of every Lenze document.

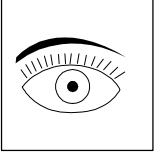

Maintenance

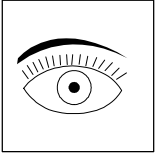

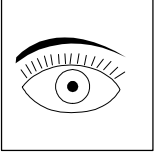

Maintenance



10 DC-bus connection

11 Application of brake units

This chapter is part of the Lenze documentation structure.

For 48XX/49XX DC controllers it is not applicable.

EDS4900U--H
00408856

Manual
Part H

Automation

DC speed controller
4800/4900

The features, data and versions indicated in this Manual met the state of the art at the time of printing.

(Printing date: inner cover pages of the parts).

In the event of deviations, please see the Operating Instructions or contact Lenze.

		revised	
Edition of:	01/03/1999		

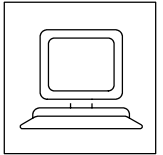

12 Automation

48XX/49XX controller can communicate with, for instance superimposed hosts (PLC or PC) as well as operating units, which work according to the LECOM protocol, by means of the serial interfaces LECOM.

12.1 LECOM1 interface

The serial interface X6, available as standard, complies with RS232C and RS485. The LECOM1 interface can be used for parameter setting, monitoring, diagnostics and simple control tasks (see chapter 4.3.8).

The LECOM-A/B protocol is based on ISO 1745 and supports up to 90 controllers. It detects faults and avoids transmission faults.

12.2 LECOM2 interface (option)

For increased demands, use fieldbus connection modules. The modules are available as operations and can be integrated in the controller. For parameter setting, the interface is called LECOM2. The following bus systems are available:

- InterBus interface module 2110 (variant V011)
- PROFIBUS interface module 2130 (variant V013)

12.3 LECOM code number

The following codes have a special meaning for serial communication. The codes C043, C068, C069 are not displayed.

- LECOM1 controller address

Enter the bus participant numbers required for communication via interface under code C009. It is possible to assign addresses from 1 to 99. "10", "20", "30"... "90" are reserved for broadcast telegrams.

- Fault display and reset

Under code C043 faults can be indicated and reset.

Parameter 0 = no fault

Parameter 1 = fault (reset: parameter input = 0)



Note!

Fault message can only be reset, after the fault has been eliminated.

- Display of the operating state

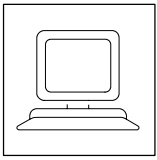

Automation

The operating state of the controller is indicated under C068. angezeigt.

Bit No.	15	14	13	12	11	10	9	8	7	6	5	4	3	2	1	0
Signal	TRIP		I _{max}	QSP	IMP	Run	n _{act} = 0	Ctrl. enable	Communication error			Operation error				

- Display of the operating state of the controller.

The operating state of the controller is displayed under C069.

Bit No.	7	6	5	4	3	2	1	0
Signal	Ctrl. enable	xxx	RESET	AUTO	REMOT	PCHG	CALARM	BALARM
Meaning	Controller enable		Controller reset	Terminal control	LECOM control	Operating mode changed	Communication error	Operation error

- LECOM1 baud rate

The baud rate can be set under C125.

Code	Name	Possible settings			Info
		Lenze	Selection		
C125*	Baud rate changeover for interface	0	-0-	9600 baud	
			-1-	4800 baud	
			-2-	2400 baud	
			-3-	1200 baud	



Note!

For communication via modem please contact Lenze.

- History of the reset fault

Codes C161 to C168 indicate the last 8 TRIPs stored. The fault reset last is indicated under C161.

- LECOM1 code bank

With version 1.0 of the LECOM-A/B protocol only codes up to C255 can be processed. The access range of this version can be changed under C249 so that it is possible to reach higher codes. Code C249 does not exist in every code range.

Parameter in C249	Access to code range
0	C000...C255
1	C250...C505
2	C500...C755
3	C750...C1005
4	C1000...C1255
5	C1250...C1505
6	C1500...C1755
7	C1750...C2000

For more information about serial communication with the standard interface LECOM1 (LECOM-A/B) see the Operating Instructions LECOM-A/B.

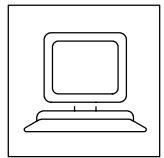

12.4 Enable LECOM interface

Use fieldbus connection modules, e.g. InterBus or PROFIBUS, to integrate the controller in more complex automation systems. These fieldbus systems ensure very fast data transfer. The controller can be connected to a winding calculator or a positioning controller using the automation module 221X.

Install the module and activate it under C370.

Code	Name	Possible settings		
		Lenze	Selection	Info
C370*	Enable automation interface		-0- No communication via automation interface -1- Communication via automation interface enabled	

If communication via C370 is enabled even if no automation module is connected, the ready (RDY) message will be output.

If communication via InterBus or PROFIBUS is required, select the necessary operating mode (-4- to -7-) under code C001. If the controller is connected to an automation module, the operating mode must not be adapted accordingly.



Note!

The LECOM2 interface is enabled independently of the default setting, i.e. when loading the default setting under C002, the parameter set under C370 remains the same.

12.4.1 Process data and parameter channel

The InterBus or PROFIBUS system provides two transmission channels:

- a fast process data channel
- a slower parameter channel

With the parameter channel, the codes can be parameterised as usual via LECOM1.

The fast process data channel enables fast transmission of time-critical process data from and to the controller. According to the DRIVECOM agreement, InterBus and PROFIBUS can only send or receive two control parameters via the process data channel.

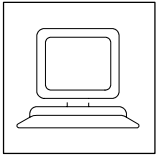

Automation

The following is available:

Process output data to be sent from the controller to the communication interface:

- Mains status word from the basic unit (index 6041hex)
- Status figure of the FDO of C151 (index 5F68hex)
- Speed set-value of C380 (index 6042hex)
- Actual speed value of C382 (index 5E81hex)
- Torque set-value of C388 (index 5E7Bhex)
- Actual phase value of C391 (index 5E78hex)

Process input data from the communication interface to be received by the controller:

- Main control word (index 6040hex)
- Freely programmable digital inputs (index 5F77hex)
- Speed main set-value of C380 (index 6042hex)
- Speed additional set-value of C393 (index 5E76hex)
- Torque set-value of C387 (index 5E7Chex)
- Field current set-value of C392 (index 5E77hex)

In default setting, the main control word and the speed main set-value are assigned to the two process input words. The main status word and the actual speed value are assigned to the process output words.

For more detailed information about the main control word, see the Operating Instructions/Manual DRIVECOM / InterBus connection module type 2110IB or the Operating Instructions PROFIBUS-FMS / DP bus connection module type 2130IB.

The control word (C136) for freely programmable digital inputs (index 5F77hex) has the following structure (see 7.1.5.1):

Bit 0:	FDI 1
Bit 1:	FDI 2
Bit 2:	FDI 3
Bit 3:	FDI 4
Bit 4:	FDI 5

The process data words are re-assigned via the communication parameter index 6000hex or 6001hex and 6002hex.

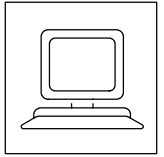

12.4.2 High precision set and actual values

Select high precision set and actual values with a resolution of 14 bit plus sign under codes C380 to C393. Here, the controller value can be directly read or written without any conversion errors.

These codes can only be accessed via the LECOM interface.

C380 n_{set} speed

Input and display of the main set-value. The main set-value is normalized to the max. speed (C011).

The figure $2^{14} = 16384$ corresponds to 100% of the maximum speed. The information is the same as under C046. The only difference is that the controller value can be directly read without any conversion errors.

C381 n_{set} at speed controller

Display of the sum calculated from the mains set-value and the additional set-value, each after the ramp function generator and normalized to the maximum speed set under C011. The figure $2^{14} = 16384$ corresponds to 100% of the maximum speed. The information is the same as under C050.

C382 actual speed

Display of the actual speed for the speed controller, normalized to the maximum speed set under C011. The figure $2^{14} = 16384$ corresponds to 100% of the maximum speed. The information is the same as under C051.

C387 torque limit

Input and display of the torque limit for the controller. The figure $2^{14} = 16384$ corresponds to 100% of the maximum torque. The information is the same as under C047.

C388 torque set-value

Display of the torque set-value for the controller. The figure $2^{14} = 16384$ corresponds to 100% of the maximum torque. The information is the same as under C056.

C391 act. phase value

Display of the actual phase value when using a resolver or incremental encoder as actual value encoder. The figure $2^{14} = 16384$ corresponds to 360°. The maximum display value can be 65535, so that 4 revolutions can be detected. With incremental encoder feedback, 0 is displayed until the zero pulse is set.

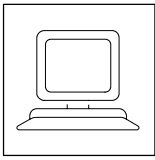

Automation

C392 field current set-value



Note!

The field current cannot be reduced more than to the minimum field current set under C231. If the controller is in field-weakening operation, this range cannot be left by setting a higher field current set-value.

Display of the field current set-value. The figure $2^{14} = 16384$ corresponds to 100% of the rated value under C083. The field current set-value can be assigned to a process input word so that the set-value can be controlled via the fieldbus system.

C393 additional set-value

Display of the additional set-value for the speed controller. The figure $2^{14} = 16384$ corresponds to 100% of the maximum additional set-value. The information is the same as under C049.

Code	Name	Possible settings			Info
		Lenze	Selection		
C380*	n_{set} speed		-16384	{1} 16384	High precision set-value input: 16384 100% under C046 Input only via interface
C381*	n_{set} at n controller		-32767	{1} 32767	High precision set-value display: Input of the speed controller 16384 100% under C050. Input only via interface.
C382*	Actual speed		-32767	{1} 32767	High precision display: actual speed value 16384 n_{max} under C011. Input only via interface.
C387*	Torque limit		-16384	{1} 16384	High precision torque set-value input: 16384 100% under C047. Input only via interface.
C388*	Torque setpoint		-16384	{1} 16384	High precision torque set-value display: 16384 100% under C056. Input only via interface.
C391*	Actual phase		0	{1} 65535	High precision display of the actual phase value if resolver or incremental encoder operate as feedback system: 16384 360 1 revolution Input only via interface.
C392*	Field current set-value		0	{1} 16384	High precision display of the field current set-value: 16384 I_{rated} under C083. Input only via interface.
C393*	Additional set-value		-16384	{1} 16384	High precision additional set-value display: 16384 100% under C049. Display only via interface.

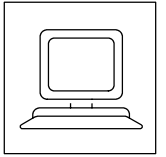



Automation

EDS4900U--I
00408857

Manual

Part I

Accessories and motors

DC speed controller
4800/4900

The features, data and versions indicated in this Manual met the state of the art at the time of printing.

(Printing date: inner cover pages of the parts).

In the event of deviations, please see the Operating Instructions or contact Lenze.

		revised	
Edition of:	01/03/1999		

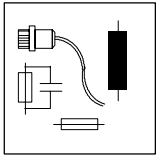

13 Accessories

For the controllers, Lenze offers the following accessories (to be ordered separately):

- Mains chokes
- RFI filters
- Fuses
- Fuse holders
- System cable for resolver / incremental encoder
- System cable for digital frequency coupling.

A PC can be connected to the controller via the fieldbus module LECOM A/B (RS232, RS485 or fibre optics). The parameter setting of the controller is very easy using LEMOC 2.

PC program LEMOC2

The program runs under DOS and is supplied with drivers for LECOM A/B (RS232, RS485 or fibre optics).

Functions of the program:

- Well-structured parameter setting and diagnosis
- Easy backup

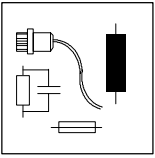

13.1 Fuses



Note!

The fuses protect the controller from impermissible operating conditions. After a protection function has been activated, the controller or system must be checked for faults before replacing the fuse.

Because of possible damage to the semiconductor fuses, which have not blown, replace the complete set (phase and armature fuses).

Ensure to use the same fuse type of the same manufacturer as used before.

To protect the semiconductors (thyristors) from short-circuit, use very quick-acting fuses. The characteristics of fuse and semiconductor must be adapted to each other.

- The tables TAB 1 and TAB 3 list the max. permissible fuse sizes, which protect the semiconductors in the event of short-circuit, for all controller sizes.

The protection characteristics of the fuses are guaranteed even if the controller is operated with max. armature current (1.2 to 1.8 times rated current of the controller).

The fuses are recommended for standard controllers as well as for variants with "500V mains voltage".

- For applications which do not require the max. permissible armature current, check whether it is possible to use smaller rated fuse currents. The tables TAB 2 and TAB 4 list the assignment of the fuses to the controller sizes (mains voltage 340 ... 460 V $\pm 0\%$) on condition that the max. armature current (C022, C023) does not exceed the rated armature current of the controller.

With fuses other than recommended, check the switch-off characteristic and whether the actual load cycle does not lead to early ageing of the fuse.

For further information, please contact Lenze or the fuse supplier.

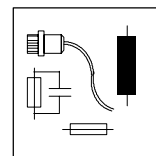

13.1.1 Mains fuses



Stop!

An additional cable protection is required when using fuses of the operating class aR (partial characteristic) as phase fuses.

If the fuses of the operating class gR also protect the cable, the cable cross-sections must be dimensioned according to the fuse. Otherwise, provide a separate cable protection!

Type	Max. perm. size of the phase fuse (F'1, F'2, F'3) Mains voltage $\leq 550V + 0\%$			Fuse holder
	Fuse type	Operating class	Order designation	Order designation
4902	FF 32 A (22 x 58)	gR	EFSFF0320AYI	EFH30006
4903	FF 40 A (22 x 58)	gR	EFSFF0400AYI	EFH30006
4904	FF 80 A (22 x 58)	gR	EFSFF0800AYI	EFH30006
4905	FF 200 A (01.110)	aR	EFSFF2000AYR	EFH10003
4906	FF 250 A (01.110)	aR	EFSFF2500AYR	EFH10003
4907	FF 350 A (01.110)	aR	EFSFF3500AYR	EFH10003
4X08	FF 450 A (01.110)	aR	EFSFF4500AXP	EFH10003
4X09	FF 700 A (02.110)	aR	EFSFF7000AYR	EFH10003

TAB 1 Assignment of max. mains fuse size to the controller

Type	Recommended phase fuse size (F'1, F'2, F'3) when $I_{Amax} = I_{Arated}$ of the controller Mains voltage $\leq 460V + 0\%$			Fuse holder
	Fuse type	Operating class	Order designation	Order designation
4902	FF 20 A (14 x 51)	aR	EFSFF0200AYH	EFH10002
4903	FF 32 A (14 x 51)	aR	EFSFF0320AYH	EFH10002
4904	FF 63 A (22 x 58)	aR	EFSFF0630AYI	EFH30006
4905	FF 125 A (00.80)	aR	EFSFF1250AXL	EFZ0003
4906	FF 200 A (00.80)	aR	EFSFF2000AXL	EFZ0003
4907	FF 315 A (00.80)	aR	EFSFF3150AXL	EFZ0003
4X08	FF 400 A (01.110)	aR	EFSFF4000AXR	EFH10003
4X09	FF 550 A (01.110)	aR	EFSFF5500AXP	EFH10003

TAB 2 Assignment of mains fuses to the controller when $I_{Amax} = I_{Arated}$ and a mains voltage of $\leq 460V + 0\%$

The controllers 4X11 to 4X13 are equipped with cell fuses (F1.1/F1.2, F2.1/F2.2, F3.1/F3.2). Fuseholders are not necessary.

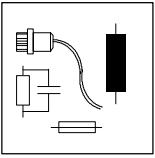

Accessories

13.1.2 Armature fuses

Armature fuses protect the thyristors of the controller from feedback of the motor in generator mode.

When using AC fuses as armature fuses, the max. operating voltage of the semi-conductor fuse is restricted, because of the time constant L/R of the armature circuit.

Therefore, the rated fuse voltage of the following fuse type is considerable higher than the voltage of the phase fuses recommended.

Type	Max. perm. fuse size for the armature circuit (F'4) Mains voltage $\leq 550V + 0\%$			Fuse holder
	Fuse type	Operating class	Order designation	Order designation
4902	FF 40 A (27 x 60)	1	EFSCC0400AYJ	EFH30005
4903	FF 50 A (27 x 60)	1	EFSCC0500AYJ	EFH30005
4904	FF 100 A (27 x 60)	1	EFSCC1000AYJ	EFH30005
4905	FF 250 A (01.110)	aR	EFSFF2500AZR	EFH10003
4906	FF 315 A (01.110)	aR	EFSFF3150AZR	EFH10003
4907	FF 400 A (02.110)	aR	EFSFF4000AZR	EFH10003
4X08	FF 550 A (03.110)	aR	EFSFF5500AZR	EFH10003
4X09	FF 800 A (03.110)	aR	EFSFF8000AZR	EFH10003

TAB 3 Assignment of max. armature fuse size to the controller

1 DC fuse

Type	Recommended armature fuse size (F'4) when $I_{Amax} = I_{Arated}$ of the controller Mains voltage $\leq 460V + 0\%$			Fuse holder
	Fuse type	Operating class	Order designation	Order designation
4902	FF 20 A (14 x 51)	aR	EFSFF0200AYH	EFH10002
4903	FF 32 A (14 x 51)	aR	EFSFF0320AYH	EFH10002
4904	FF 80 A (22 x 58)	aR	EFSFF0800AYI	EFH30006
4905	FF 125 A (00.80)	aR	EFSFF1250AXL	EFZ0003
4906	FF 200 A (00.80)	aR	EFSFF2000AXL	EFZ0003
4907	FF 315 A (00.80)	aR	EFSFF3150AXL	EFZ0003
4X08	FF 500 A (02.110)	aR	EFSFF5000AZR	EFH10003
4X09	FF 700 A (02.110)	aR	EFSFF7000AXP	EFH10003

TAB 4 Assignment of armature fuses to the controller when $I_{Amax} = I_{Arated}$ and at a mains voltage of $\leq 460V + 0\%$

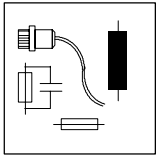

13.1.3 Internal fuses

Except for the cell fuses, all fuses are on the board 4902/3/5 LP or 4X08/11 LP.

	Type	Rated data			Order designation
		Fuse type	V [V]	Dimensions [mm]	
Field fuses F1, F2	4902 ... 4907	FF 16 A	500	6.3 x 32	EFSFF0160AWB
	4X08 ... 4X13	FF 32 A	600	14 x 51	EFSFF0320AYH
Electronics fuses F3, F4		M0.5 A	500	5 x 30	EFSM-0005AWA
Overvoltage protection F5, F6, F7		FF16 A	500	6.3 x 32	EFSFF0160AWB
Cell fuses F1.1/F1.2 F2.1/F2.2 F3.1/F3.2	4X11	500 A	1000	01.80	EFSFF5000AZ
	4X12	800 A	1000	02.80	EFSFF8000AZ
	4X13	900 A	1000	03.80	EFSFF9000AZ

13.1.4 Fuse holder

Order designation	Fig.	Dimensions				
		a [mm]	b [mm]	e [mm]	m [mm]	c [mm]
EFH10002	FIG 13-1	17.5	97	78.5	-	-
EFH30006	FIG 13-1	35	125	83	-	-
EFH30005	FIG 13-2	see figure				
EFZ0003	FIG 13-3	40	146	43	6	25
EFH10003	FIG 13-4	see figure				

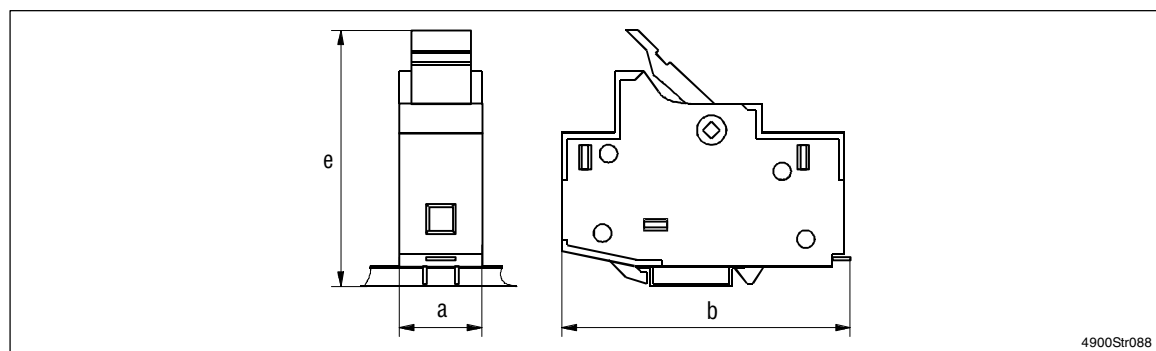
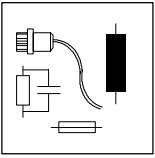

FIG 13-1 Fuse holder for DIN rail assembly (35mm)



Accessories

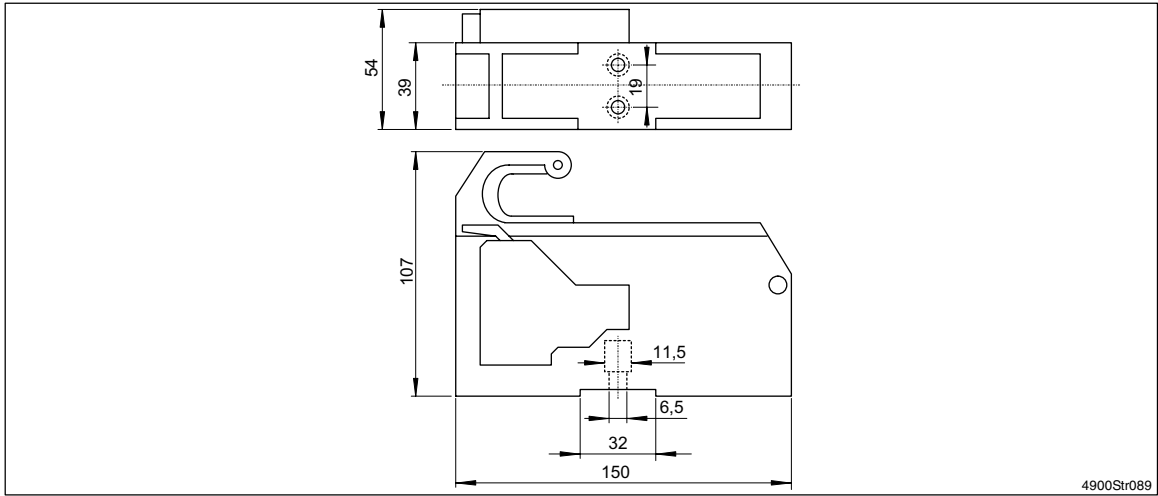

FIG 13-2 Fuse holder order No.: EFH30005

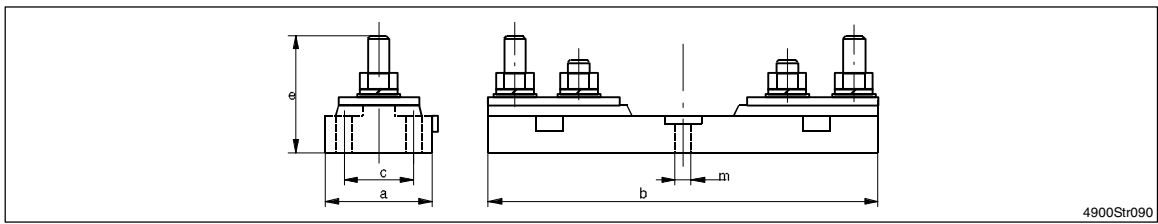

FIG 13-3 Insulating base order No.: EFZ0003

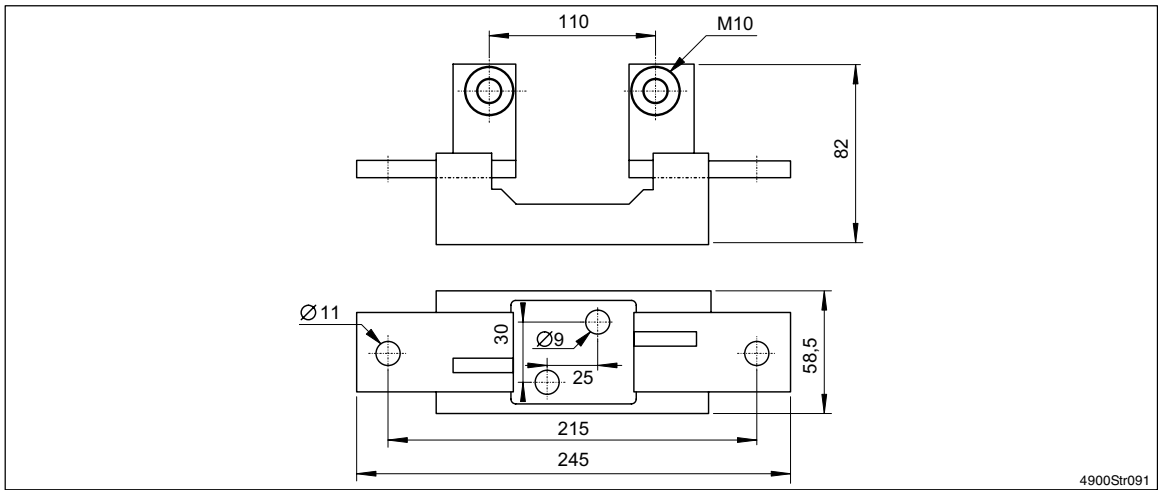
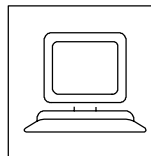

FIG 13-4 Insulating base order No.: EFH10003



13.2 Mains chokes

The following mains chokes are for operation with mains voltages up to $\leq 550V$ + 0%.

13.2.1 Mains chokes for power connection

Type	Rated data				Order designation
	L	I	P_{loss}^1 [W]	m [kg]	
4902	3 · 1.2 mH	3 · 17 A	30	3	ELN3-0120H017
4903	3 · 1.1 mH	3 · 25 A	46	6	ELN3-0120H025
4904	3 · 0.75 mH	3 · 45 A	80	10	ELN3-0075H045
4905	3 · 0.27 mH	3 · 105 A	120	20	ELN3-0027H105
4906	3 · 165 μ H	3 · 170 A	125	32	ELN3-0017H170
4907	3 · 115 μ H	3 · 270 A	215	40	ELN3-0011H270
4X08	3 · 94 μ H	3 · 300 A	220	50	ELN3-0009H300
4X09	3 · 60 μ H	3 · 450 A	245	58	ELN3-0006H450
4X11	3 · 46 μ H	3 · 600 A	280	77	ELN3-0005H600
4X12	3 · 32 μ H	3 · 900 A	390	125	ELN3-0003H900
4X13	3 · 28 μ H	3 · 1000 A	360	115	ELN3-0003H1k0

1) for operation with rated current

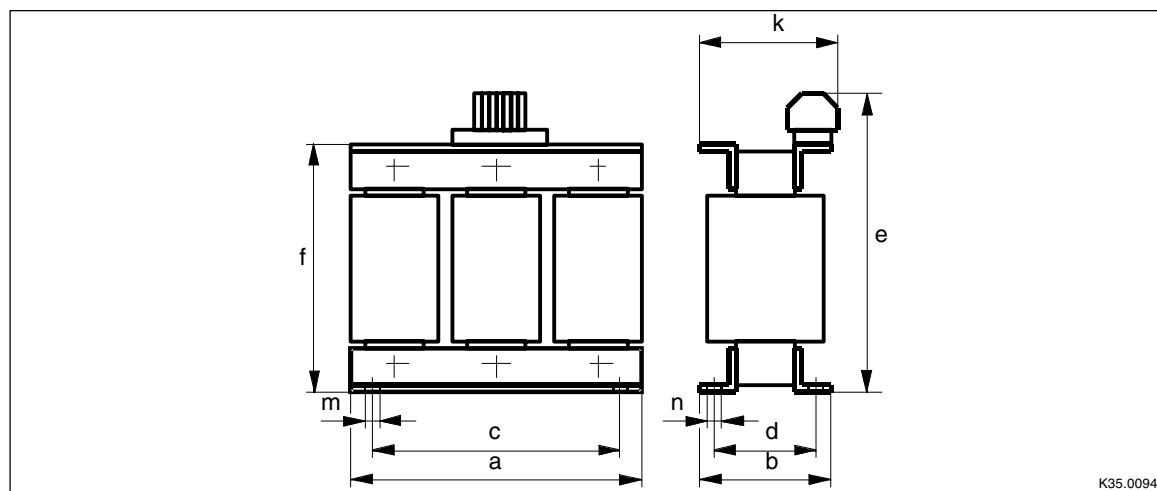
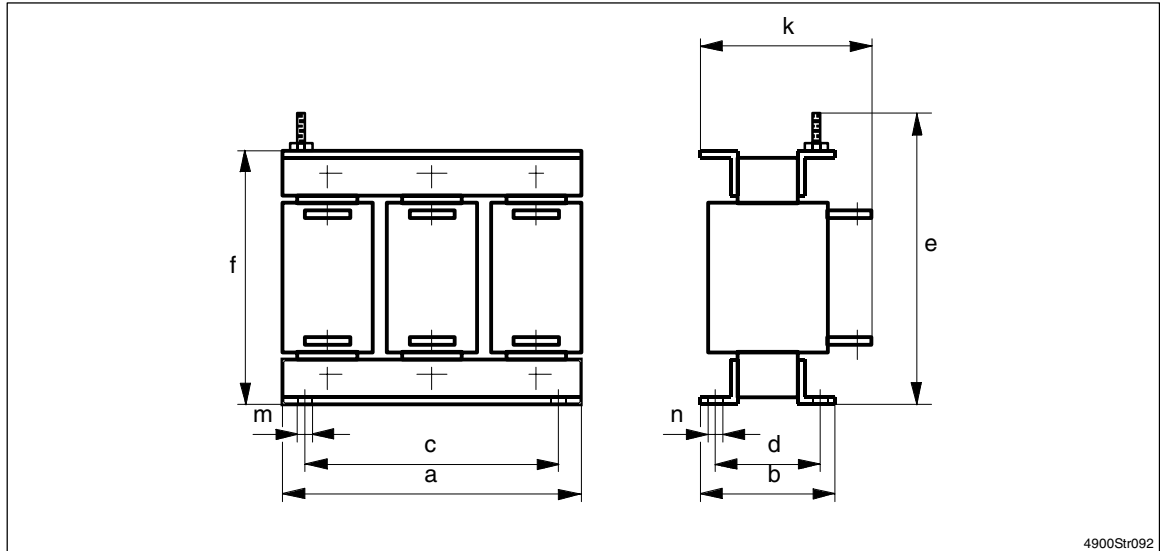

FIG 13-5 Mains chokes with connection lug



4900Str092

FIG 13-6 Mains chokes with connection lug

Type	FIG	a	b	c	d	e	f	k	m	n
4902	FIG 13-5	120	65	109	51	162	110	80	5	10
4903	FIG 13-5	150	76	140	61	180	140	95	5	10
4904	FIG 13-5	180	91	161	74	225	165	120	6.3	11
4905	FIG 13-5	228	111	206	94	273	205	150	6.3	11
4906	FIG 13-5	264	128	240	107	257	237	166	8.3	16
4907	FIG 13-5	300	140	274	114	290	265	190	8.3	16
4X08	FIG 13-6	300	140	224	105	290	270	200	10	18
4X09	FIG 13-6	360	140	330	105	330	318	210	10	18
4X11	FIG 13-6	360	140	330	137	345	320	250	10	18
4X12	FIG 13-6	420	220	370	160	400	365	290	12	16
4X13	FIG 13-6	420	192	385	157	385	370	265	12	21

All dimensions in mm

13.2.2 Mains choke for separate supply of the field bridge

Type	Rated data				Order designation
	L [mH]	I [A]	P _{loss} ¹⁾ [W]	m [kg]	
4902 ... 4903	9	5	11	1.0	ELN1-0900H005
4904 ... 4X08	3.5	14	28	2.4	ELN1-0350H014
4X09 ... 4X13	0.98	35	35	2.9	ELN1-0009H035

1) for operation with rated current

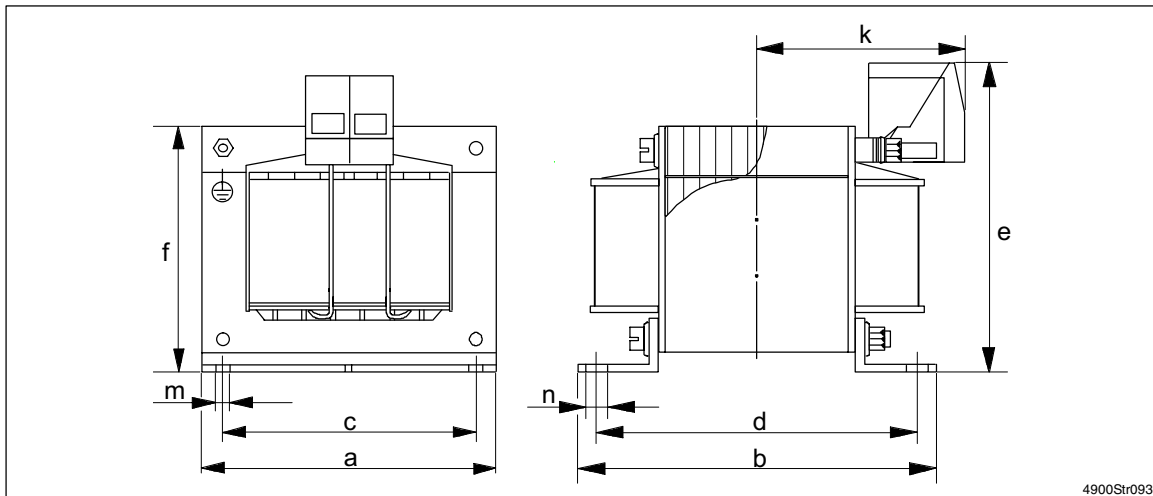
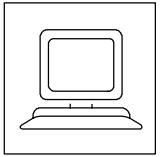
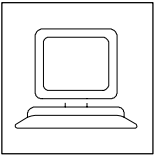

FIG 13-7 Mains choke for separate supply of the field bridge

Type	a	b	c	d	e	f	k	m	n
4902 ... 4903	66	67	50	53	80	61	37	4.8	9
4904 ... 4X08	96	77	84	61	96	87	52	5.5	9
4X09 ... 4X13	96	88	84	70	112	87	64	5.5	9

All dimensions in mm



13.3 Pre-assembled Lenze system cable

13.3.1 Resolver connection cable

Design	Length [m]	Order designation
Plug at both ends	5	EWLR005GM
	10	EWLR010GM
	15	EWLR015GM
	20	EWLR020GM
	25	EWLR025GM
	30	EWLR030GM
	35	EWLR035GM
	40	EWLR040GM
	45	EWLR045GM
50	EWLR050GM	
only with motor plug	10	EWL0028
only with plug X7 for controller	2.5	EWL0027

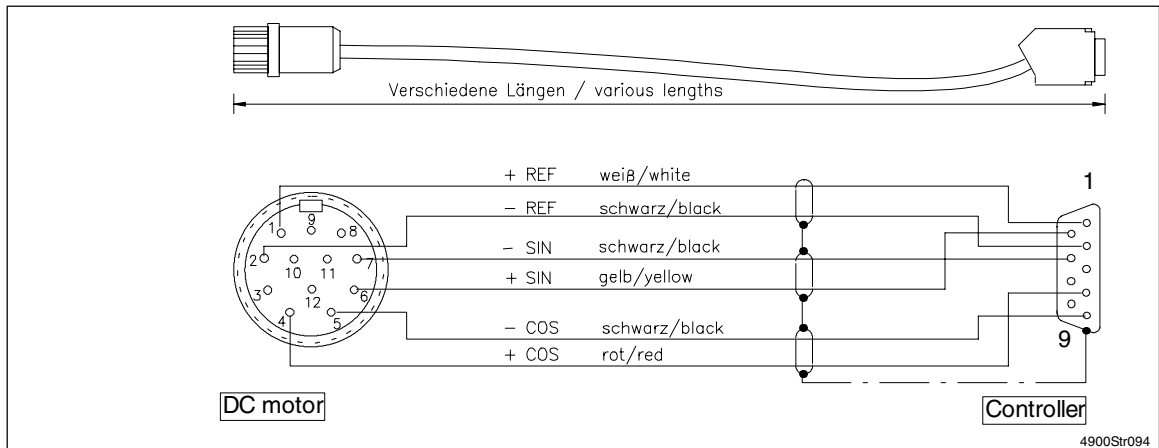

FIG 13-8 Resolver connection cable



13.3.2 Incremental encoder connection cable

Design	Length [m]	Order designation
Plug at both ends	2.5	EWLE002GM-T
	5	EWLE005GM-T
	10	EWLE010GM-T
	15	EWLE015GM-T
	20	EWLE020GM-T
	25	EWLE025GM-T
	30	EWLE030GM-T
	35	EWLE035GM-T
	40	EWLE040GM-T
	45	EWLE045GM-T
	50	EWLE050GM-T
	75	EWLE075GM-T
	100	EWLE100GM-T

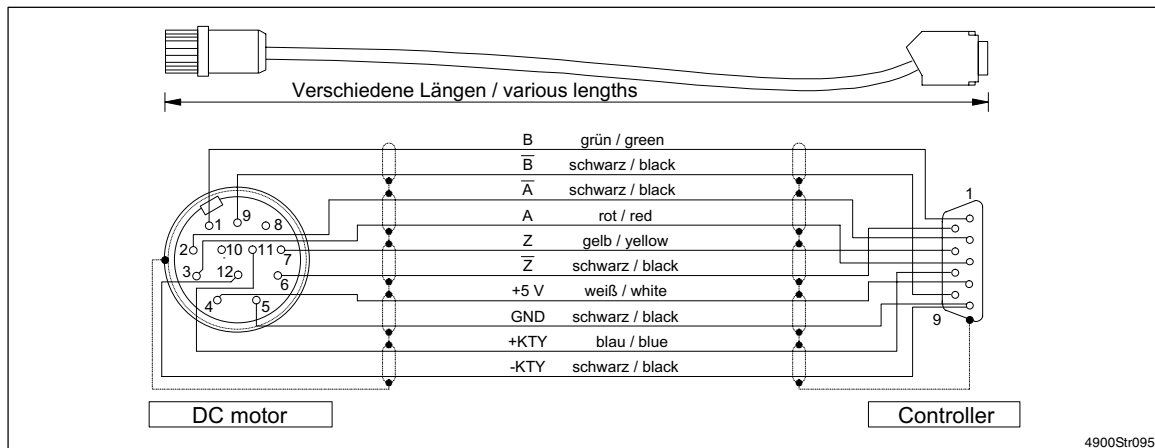

FIG 13-9 Incremental encoder connection cable

13.3.3 System cable for digital frequency coupling

Design	Length [m]	Order designation
Pin/socket	2.5	EWLD002GGBS92



13.4 RFI filter

13.4.1 RFI filter for power connection

Type	I_{rated} [A]	P_v [W]	V_{max}	m [kg]	Order designation
4902	16	12	550V \pm 0%	4.0	EZF3-016A004
4903	25	15		4.0	EZF3-025A002
4904	50	15		4.0	EZF3-050A005
4905	120	33		10	EZF3-120A001
4906	180	40		13	EZF3-180A002
4907	250	12		15	EZF3-250A001
4X08	320	21		21	EZF3-320A001
4X09	600	57		22	EZF3-600A001
4X11	600	57		22	EZF3-600A001
4X12	1000	100		28	EZF3-1k0A001
4X13	1000	100		28	EZF3-1k0A001

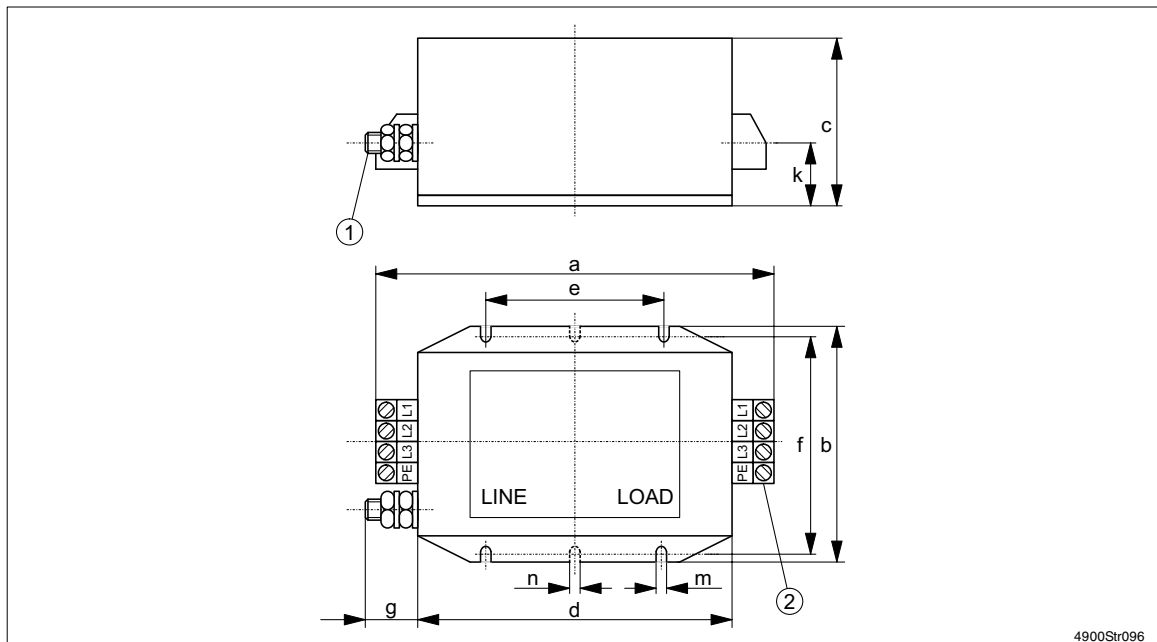

FIG 13-10 RFI filter, design A

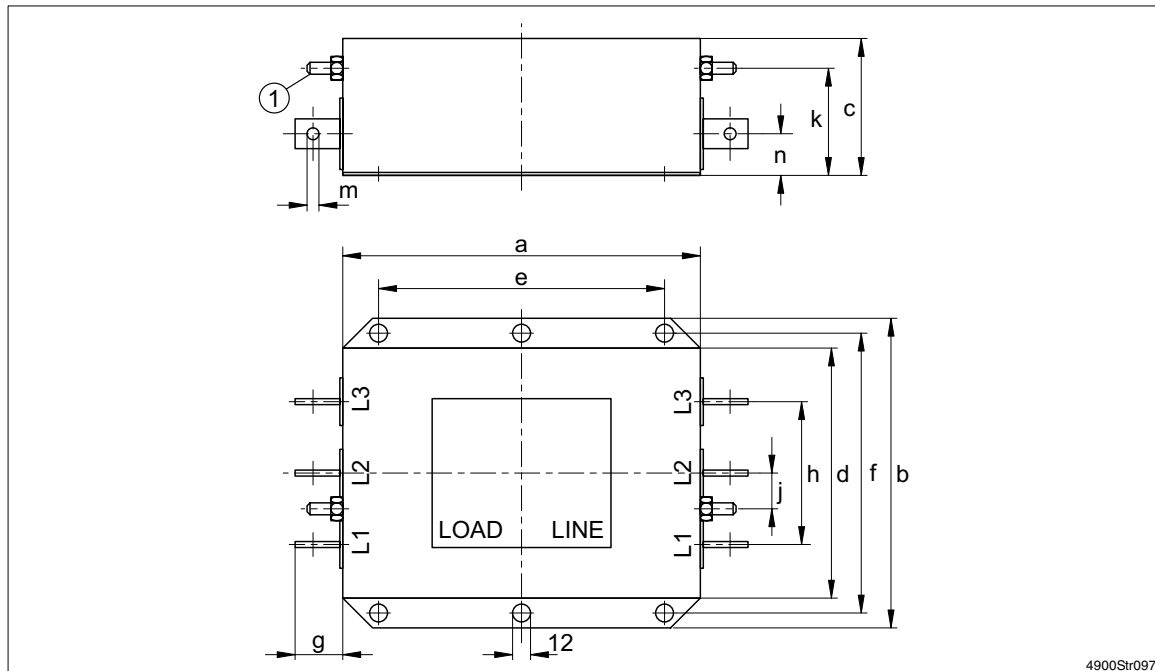
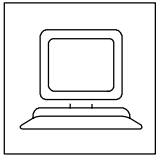
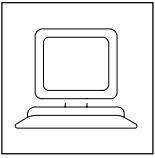

FIG 13-11 RFI filter, design B

Type	Design	a	b	c	d	e	f	g	h	i	k	m	n	À	Á [mm ²]
4902	A	163	113	81	141	70	100	22.5	-	-	25	5.5	0	M6	4
4903	A	216	156	91	166	80	140	22.5	-	-	30	6.6	0	M6	10
4904	A	216	156	91	166	80	140	22.5	-	-	30	6.6	0	M6	10
4905	A	348	171	141	261	115	155	32	-	-	65	6.6	0	M10	50
4906	A	404	171	141	301	165	155	32	-	-	62	6.6	6.6	M10	95
4907	B	300	190	115	140	240	165	40	80	30	90	11	30	M10x30	-
4X08	B	300	260	115	210	240	235	40	120	30	90	11	35	M10x30	-
4X09	B	350	260	115	210	290	235	40	120	30	90	11	35	M10x30	-
4X11	B	350	260	115	210	290	235	40	120	30	90	11	35	M10x30	-
4X12	B	350	300	165	250	290	275	50	160	40	140	14	60	M12x30	-
4X13	B	350	300	165	250	290	275	50	160	40	140	14	60	M12x30	-

All dimensions in mm



13.4.2 RFI filter for fan supply

The 4X08 to 4X13 controllers must be connected to a voltage between 200 ... 240V~ to supply the fan.

Use the following RFI filter to ensure the CE conformity of the drive system:

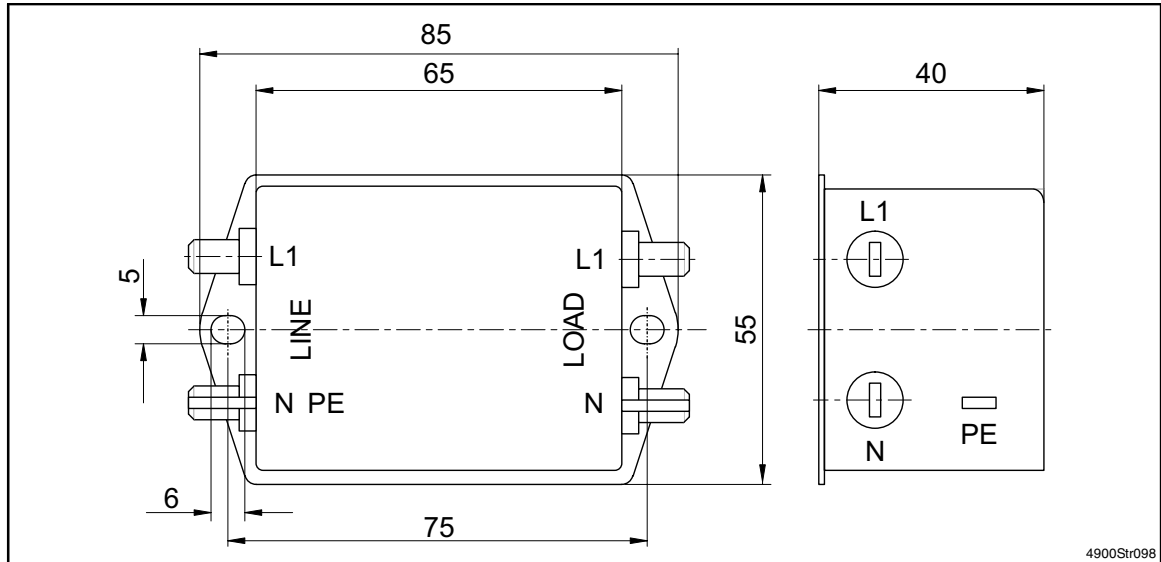
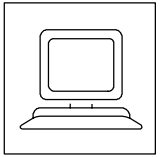

FIG 13-12 RFI filter for fan supply

Type	I_{rated} [A]	V_{max} [V]	m [kg]	Order designation
4X08 ... 4X13	4	250	0.25	EZF1-004A001



13.5 Networking accessories

The modules listed in the following are for controller networking.

13.5.1 Connection elements for optical fibres

For networking with optical fibres, Lenze offer various connection elements (optical fibre system components 212X IB), which are especially adapted to the controllers. Connection elements are adapters with optical sender and receiver, distributor and power supply. Optical fibres ensure very noise-resistant data transmission.

For further information, please see the Operating Instructions LECOM-LI.

13.5.2 Level converter

With the 2101 level converter serial transmission signals of standard RS232 can be changed to standard RS485 or RS422. Furthermore, the converter ensures electrical isolation. It is thus possible to install the drive system with large distances between the components (cable length < 1200m). The components can be connected via a multi-point connection to RS485 or a point-to-point connection to RS422.

For further information, please see the Manual 2101 (register H).



Automation

EDS4900U--K
00408858

Manual

Part K

Selection aid

Application examples

DC speed controller
4800/4900

The features, data and versions indicated in this Manual met the state of the art at the time of printing.

(Printing date: inner cover pages of the parts).

In the event of deviations, please see the Operating Instructions or contact Lenze.

		revised	
Edition of:	01/03/1999		



14 Selection aid

14.1 Assignment of controller and motor

Lenze does not only offer controllers but also a complete motor programme with surface ventilated and enclosed ventilated machines. These motors perfectly match the controllers 48XX/49XX.

On request, these motors can be equipped with the following:

- Gearbox
- Clutches/brakes
- Analog tachos
- Resolvers
- Incremental encoder

More information about installation, commissioning and maintenance of Lenze DC motors can be obtained from the Operating Instructions "DC motors".

14.1.1 Selection criteria

The electrical rated data (armature current, armature voltage) of the controller should be more or less the same as for the driving motor to ensure optimum operating features of the whole drive (controller and motor, see chapter 3.3).

Since the motor provides overcurrent reserves from 12.5% to up to 80% over a short period of time, the compensated drive motor generated a torque increased by this factor when constantly excited.

For unadapted motors we distinguish between the following:

1. Rated armature voltage of the motor > rated armature voltage of the controller
(= max. permissible controller output voltage).
The motor cannot be fully driven at this speed. The armature voltage is proportional to the speed at constant excitation.
2. Rated armature voltage of the motor < rated armature voltage of the controller (= max. permissible controller output voltage)
The controller output voltage is to be limited to the motor voltage by setting the parameters accordingly ($C011 = n_{max}$). Check, whether the motor can be used with this control mode (insulation, commutation voltage). In general, this control mode is possible with deviations up to approx. 20%.



Selection aid



Stop!

The peak values of the mains voltage are also reached with low armature voltages (speed).

3. Rated armature current of the motor > rated armature current of the controller for continuous operation. The motor cannot be fully driven in continuous operation at this torque. The current is limited to the rated armature current. The torque is proportional to the armature current at constant excitation.



Note!

With this assignment, the armature circuit gain is increased. This may lead to overcurrents in the armature circuit, which may even cause fuse tripping. For these application, please contact Lenze.

4. Rated armature current of the motor < rated armature current of the controller for continuous operation. In this case, the current limitation I_{\max} (C022, C023) of the controller should be reduced to the motor current to avoid thermal overload of the motor caused by impermissibly high currents. If the difference is too high, use a smaller controller.



Note!

The current controller of 48XX/49XX controller is default-set for the application of adapted machines. In some cases (e.g. high ratio of electrical rated data between controller and DC machine, high dynamic control requirements) it can be necessary to optimise the current-control circuit. For these applications, please contact Lenze.



14.1.2 Armature choke

When using Lenze 48XX/49XX controller adapted to the DC motor, it is not necessary to use an armature choke.

When using other controller, check whether an armature choke will be required. See Lenze Formula Reference.

An armature choke reduces

- the ripple content of the DC (lower thermal armature losses)
- the magnetic motor noises
- the torque harmonic waves for extremely high requirements to the uniformity of the torque characteristic
- the brush wear.



Stop!

An additional inductance may cause a vibration of the drive. Please contact Lenze before using an armature choke.

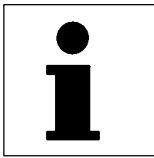

Selection aid

The following table indicates planning recommendations for components completing your drive.

Requirement/ application	Resolver	Incremental encoder (4096 incr/rev.)	Tacho		Armature voltage	Field voltage		
			20V	60V		200V	340V	360V
Field weakening	-	-	-	up to 3000 rpm	no	++	++	o
Field constant	-	-	-	-	-	++	++	no
Torque control	-	-	-	-	-	++	++	no
Dig. frequency coupling	++	++	no	no	no	-	-	-
Speed setting range	$\frac{n_{\text{rated}}}{n_{\text{min}}}$ *)							
1:20	++	++	++	++	+	-	-	-
1:50	++	++	++	++	o	-	-	-
1:200	++	++	++	++	no	-	-	-
1:500	++	++	o	o	no	-	-	-
1:1000	++	++	no	no	no	-	-	-
1:2000	+	++	no	no	no	-	-	-
Speed accuracy	$\frac{n_{\text{set}} - n_{\text{act}}}{n_{\text{rated}}}$ *)							
5%	++	++	++	++	++	-	-	-
1%	++	++	+	+	no	-	-	-
0.5%	++	++	o	o	no	-	-	-
0.1%	++	++	no	no	no	-	-	-
0.05%	++	++	no	no	no	-	-	-
Maximum speed								
up to 5000rpm	++	++	+	no	-	-	-	-
up to 3000rpm	++	++	+	+	-	-	-	-
up to 2000rpm	++	++	+	+	-	-	-	-
up to 1000rpm	++	++	o	o	-	-	-	-
up to 500rpm	++	++	o	o	-	-	-	-
Torque ripple	$\frac{M_{\text{change}}}{M_{\text{rated}}}$							
5%	++	++	+	+	o	-	-	-
1%	++	++	o	o	o	-	-	-

Condition: Standard motor with $V_{\text{Arated}} = 400 \text{ V}$, $n_{\text{rated}} = 3000 \text{ rpm}$, $V_{\text{Mains}} = 400 \text{ V}$

- ++ = good
- + = acceptable
- o = tolerable
- = not relevant

*) valid for $M = 0 \dots M_{\text{rated}} = \text{constant}$ and $I_{\text{max}} (\text{C022, C023}) \triangleq 1.2 \cdot I_{\text{rated}}$



15 Application examples

The following specifications, processes, and circuitry described are for guidance only and must be adapted to your own specific application.

- Speed control with tacho
 - (This application is described in chapter 5 as commissioning example)
- Speed control with armature-voltage feedback
- Speed control with resolver
- Torque control with speed limitation
- Current-ratio control
- Dancer control at an unwinder
- Hoists
- Speed ratio synchronism
- Modular box
- Mains isolation

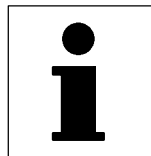

Parameter setting

Code	Input	Description
Input according to motor nameplate		
C083	xxx A	Rated field current
C084	xxx ms	Armature-time constant
C088	xxx A	Rated motor current
C090	xxx V	Rated motor voltage
Enter controller configuration		
C000	-2-	Extended code set
C005	-10-	Speed control with armature-voltage feedback
Input of current limits		
C022, C023	xxx A	Maximum motor current
Adjustment of speed controller		
C011	xxxx rpm	Enter max. speed
C025	-5-	Select armature voltage
C232	xx % V_{Arated}	I · R - Set compensation
C029	n_{act}	Adjust speed
Application parameters		
C070	V_{pn}	At high inertia, adapt n - controller gain V_{pn}
Save parameter		
C003		Save parameter set



Note!

- With armature-voltage feedback, the control terminals are still volt-free!
- Mains disconnection only when no current is applied!

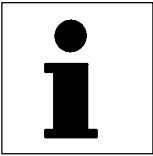

15.2 Speed control with resolver

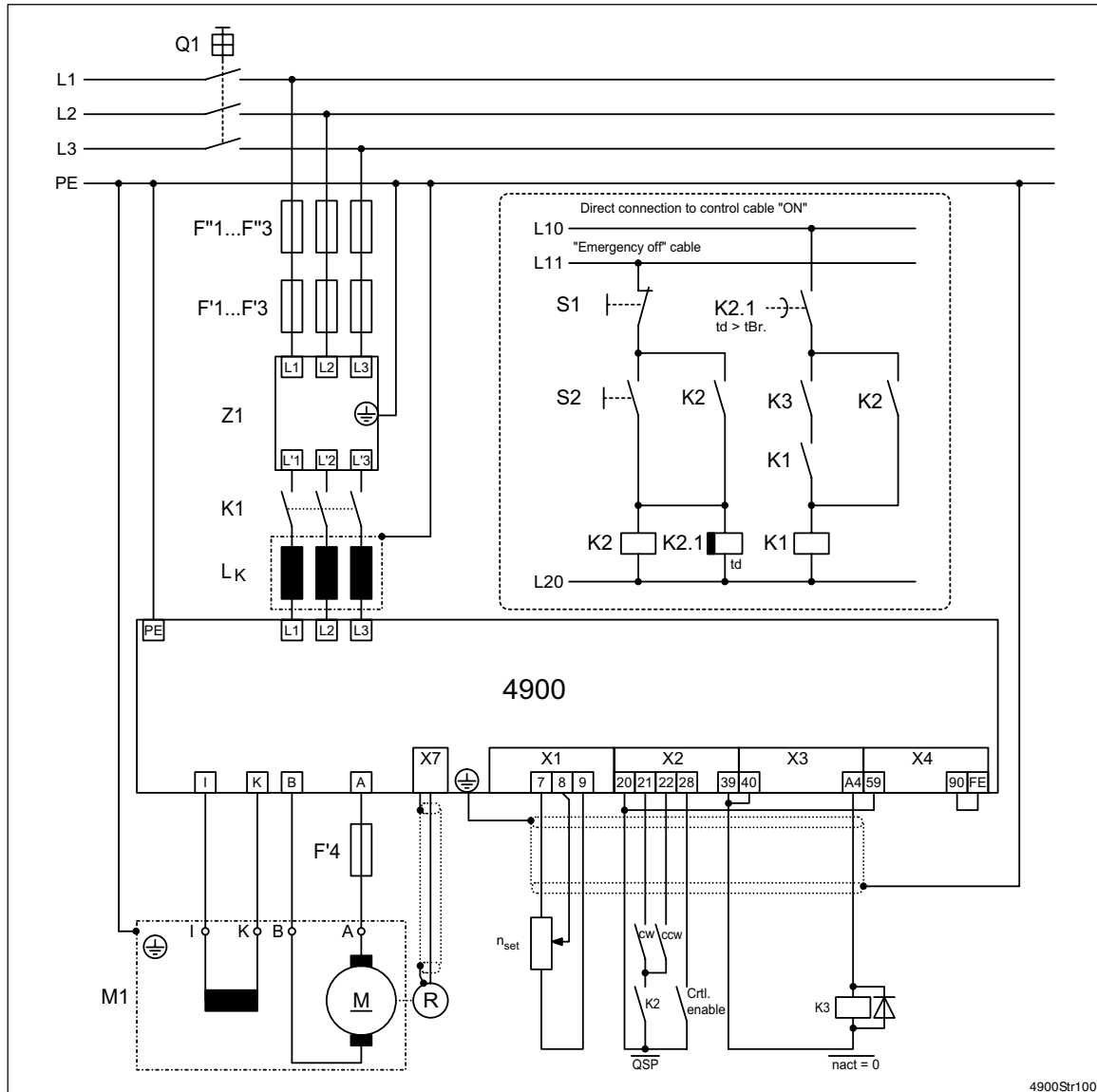

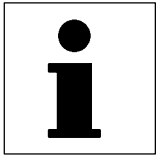

Parameter setting

Code	Input	Description
Input according to motor nameplate		
C083	xxx A	Rated field current
C084	xxx ms	Armature-time constant
C088	xxx A	Rated motor current
C090	xxx V	Rated motor voltage
Input of current limits		
C022, C023	xxx A	Maximum motor current
Enter controller configuration		
C000	-2-	Extended code set
C005	-12-	Speed control with resolver feedback
Adjustment of speed controller		
C011	xxxx rpm	Max. max. speed
Application parameters		
C019	xxxx rpm	Set threshold $n_{act} = 0$
C070	V_{pn}	At high inertia, adapt n - controller gain V_{pn}
Save parameter		
C003		Save parameter set



Selection aid

15.3 Torque control with speed limitation

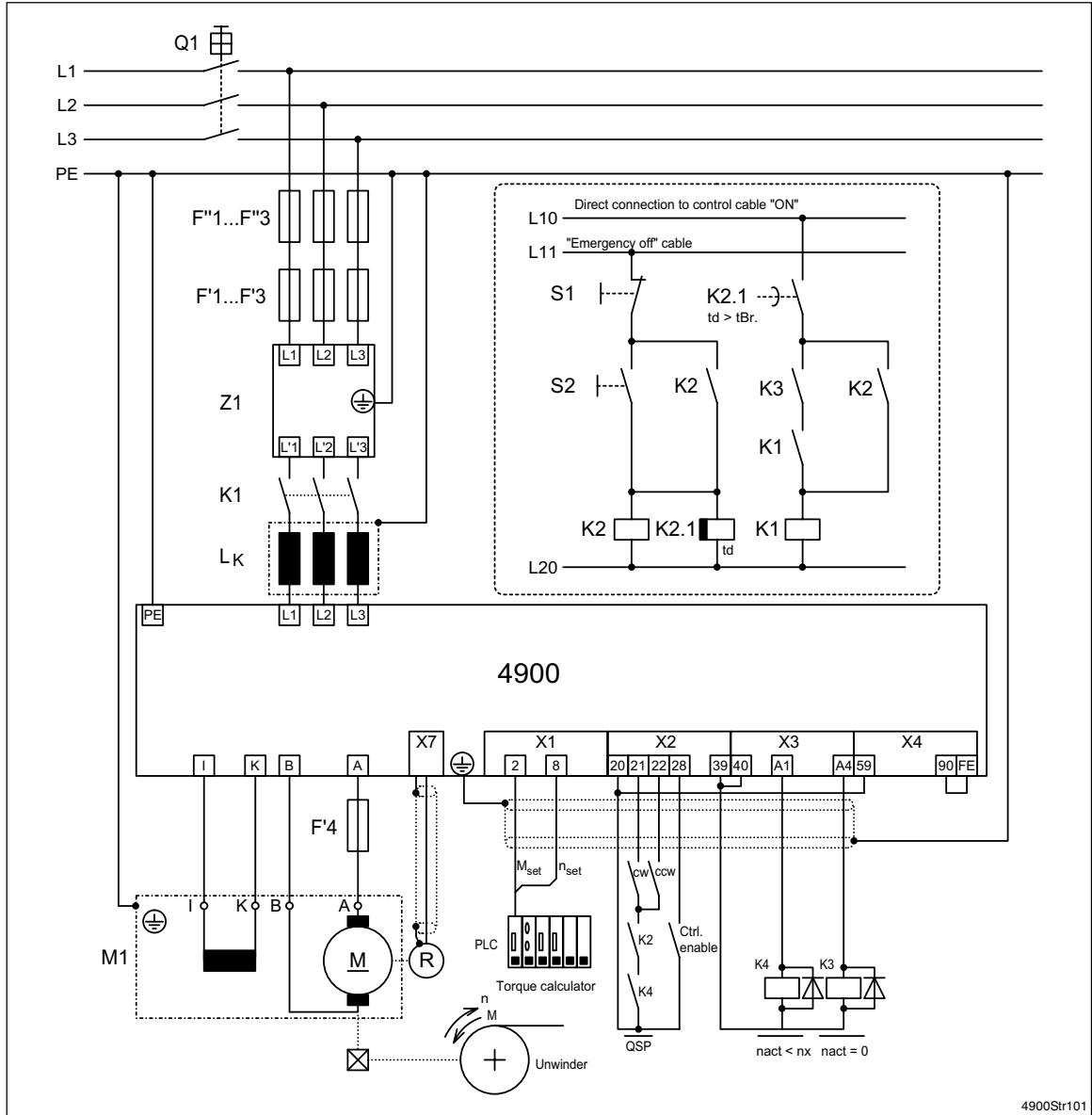
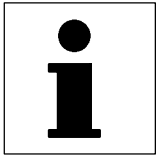

FIG 15-3 Connection diagram for torque control with speed limitation



Parameter setting

Code	Input	Description
Input according to motor nameplate		
C083	xxx A	Rated field current
C084	xxx ms	Armature-time constant
C088	xxx A	Rated motor current
C090	xxx V	Rated motor voltage
Input of current limits		
C022, C023	xxx A	Maximum motor current
Enter controller configuration		
C000	-2-	Extended code set
C005	-42-	Torque control with speed limitation
Adjustment of speed controller		
C011	xxxx rpm	Max. max. speed
Application parameters		
C019	xxxx rpm	Set threshold $n_{act} = 0$
C016	xxxx rpm	Reference speed $n_{act} < n_x$
C070	V_{pn}	At high inertias, adapt n - controller gain
Save parameter		
C003		Save parameter set



15.4 Current-ratio control

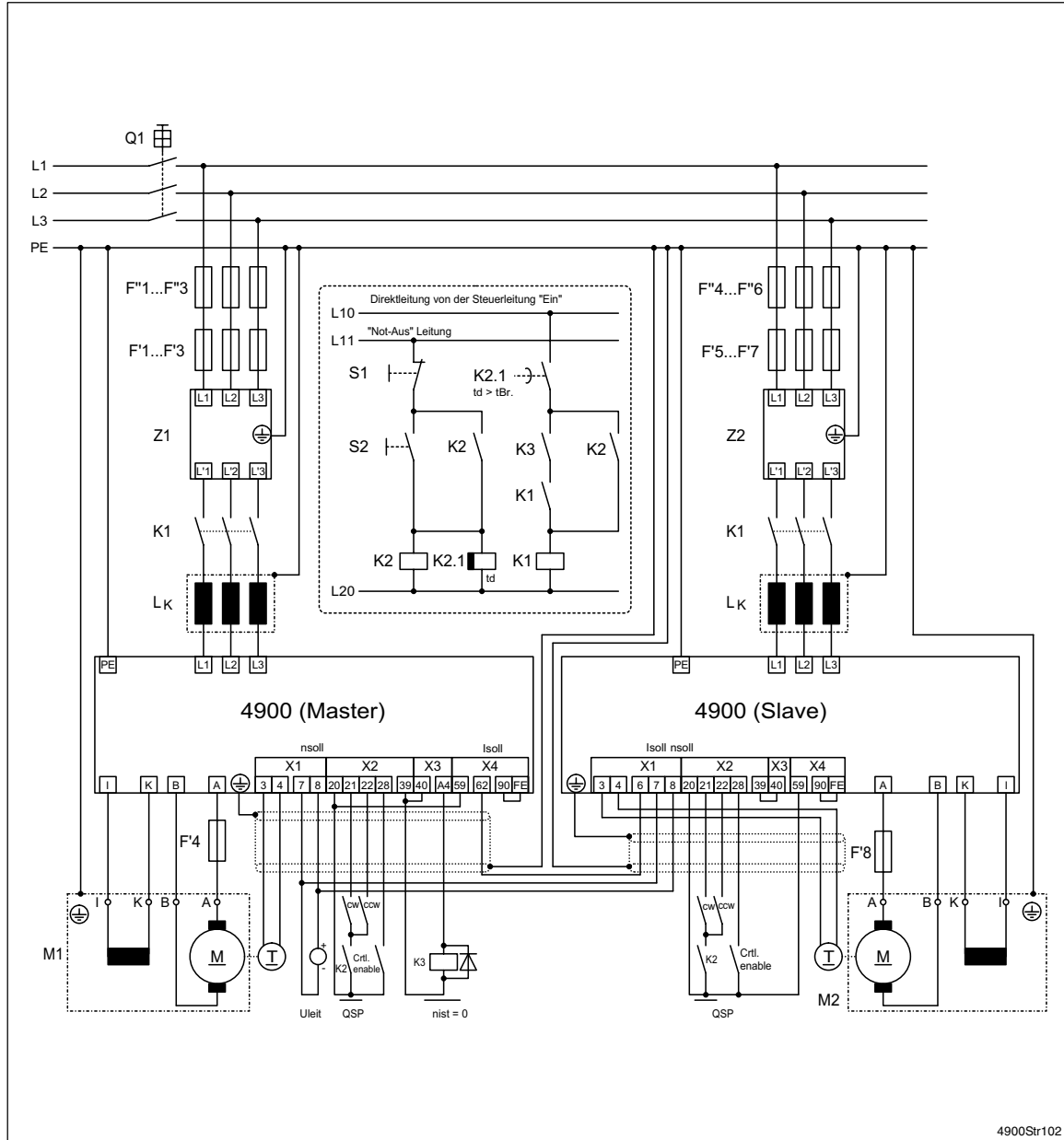
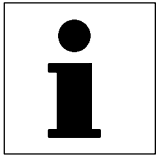

FIG 15-4 Connection diagram for current-ratio control



Parameter setting

Code	Input	Description
Input according to motor nameplate		
Master and slave		
C083	xxx A	Rated field current
C084	xxx ms	Armature-time constant
C088	xxx A	Rated motor current
C090	xxx V	Rated motor voltage
Input of current limits		
Master and slave		
C022, C023	xxx A	Maximum motor current
Enter controller configuration		
Master and slave		
C000	-2-	Extended code set
C005	-11-	Speed control with tacho feedback
Master		
C110	-1-	Input selection term. 62
C111	-25-	Monitor output 'M _{set} '
Adjustment of speed controller		
Master and slave		
C011	xxxx rpm	Select max. speed
C025	-2-	Select adjustment at terminals 3 and 4
C029		n _{act} Adjust speed
Slave		
C071	9999 ms	T _{nn} , no I component
C025	-3-	Select adjustment at terminal 6
C027		Select weighting factor for act. speed influence divided by V _{pn}
C070	V _{pn}	Adapt n-controller gain
Master and slave		
C054		Check current division between master and slave.
Application parameters		
Master		
C019	xxxx rpm	Set threshold n _{act} = 0
Save parameter		
Master and slave		
C003		Save parameter set



15.5 Dancer-position control at an unwinder

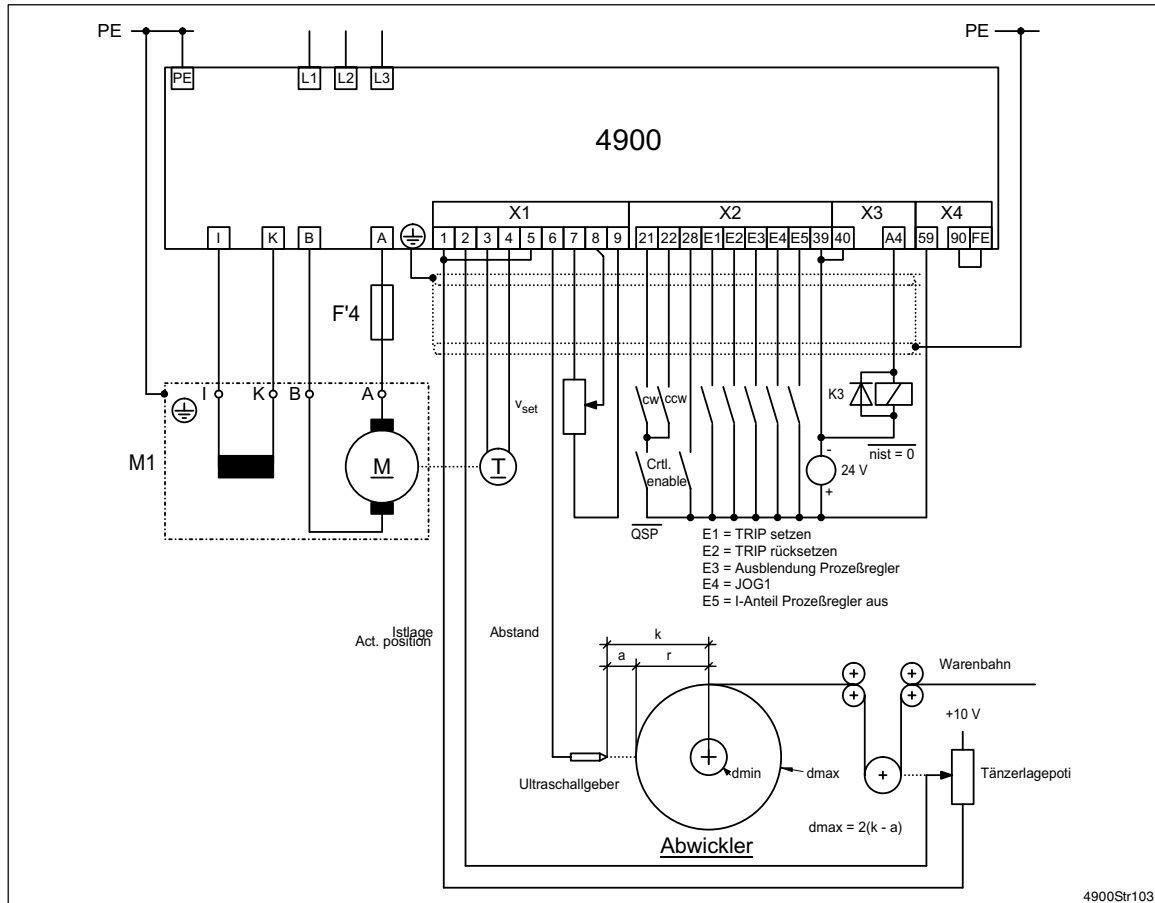
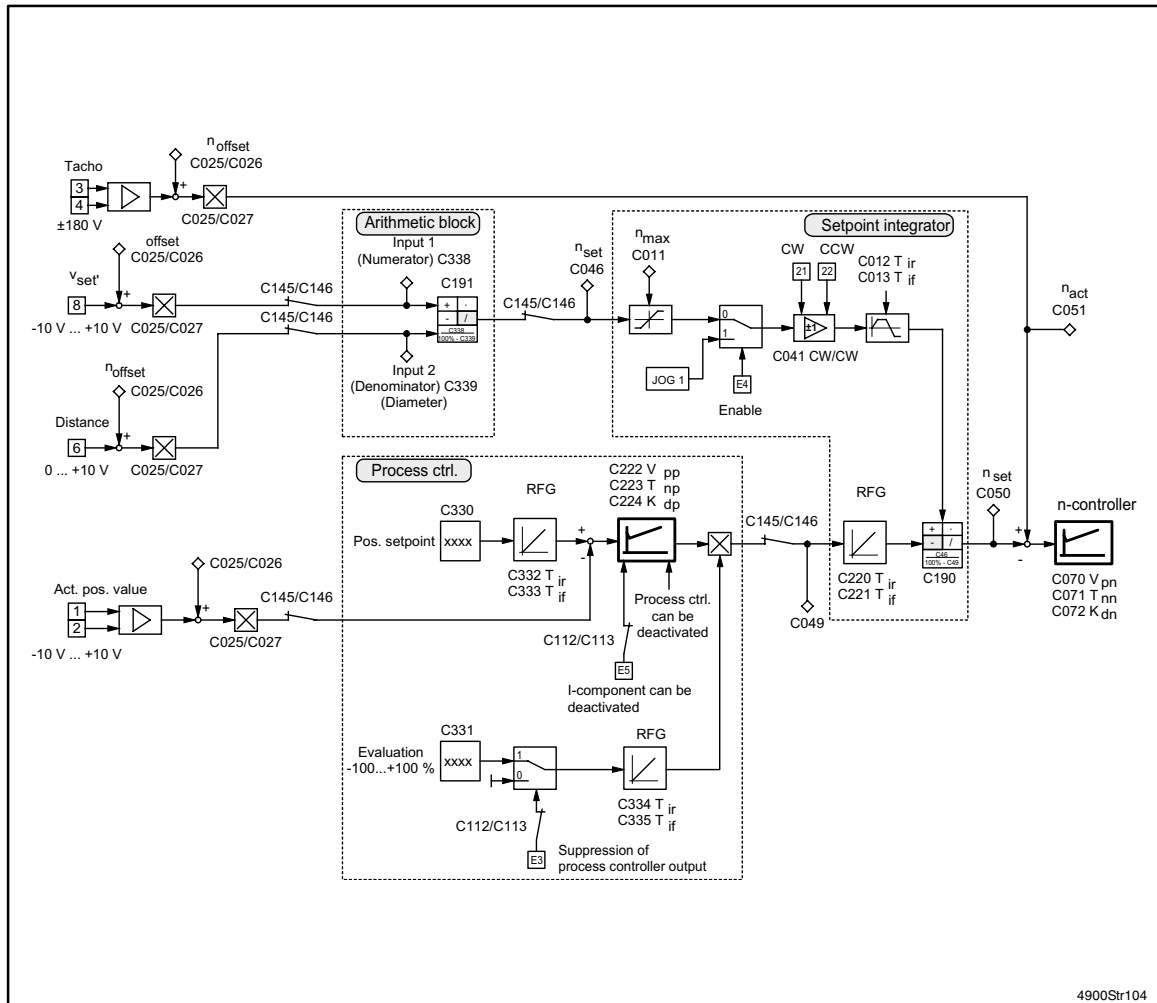
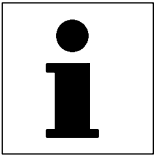
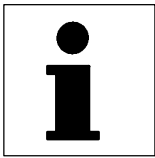

FIG 15-5 Signal-flow chart for dancer-position control at an unwinder



4900Str104

FIG 15-6 Example for a dancer-position control at an unwinder



Selection aid

Parameter setting

Code	Input	Description
Input according to motor nameplate		
C083	xxx A	Rated field current
C084	xxx ms	Armature-time constant
C088	xxx A	Rated motor current
C090	xxx V	Rated motor voltage
Freely assignable analog inputs		
C145	-4-	Input selection term. 8
C146	-15-	Arithmetic block2 input 1
C145	-3-	Input selection term. 6
C146	-16-	Arithmetic block2 input 2
C145	-10-	Input selection arithmetic block output
C146	-1-	Main set-value C046
C145	-9-	Input selection process controller output
C146	-3-	Additional set-value C049
C145	-1-	Input selection term. 1.2
C146	-7-	Actual process controller value
Freely assignable digital inputs		
C112	-3-	Input selection E3
C113	-32-	Process controller evaluation
C112	-5-	Input selection E5
C113	-31-	Process controller I component off
Arithmetic block		
C191	-4-	Output = input 1 / input 2
Convert distance → diameter		
C025	-3-	Input selection term. 6
C026		Offset for distance a = -xxx mV
C027	2.000	Evaluation for diameter
Adjustment of speed controller		
C011	xxx rpm	Enter max. speed
C025	-2-	Select adjustment at terminals 3 and 4
C029	n_{act}	Adjust speed
process controller		
C330	xxx %	Select position set-value
C331	xxx %	Evaluation of process controller output
Application parameters		
C022, C023	xxx A	Maximum motor current
C019	xxx rpm	Set threshold $n_{act} = 0$
C070	V_{pn}	At high inertias, adapt n - controller gain
C222	V_{pp}	Optimise process controller
Save parameter		
C003		Save parameter set

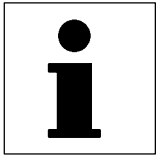

15.6 Hoists

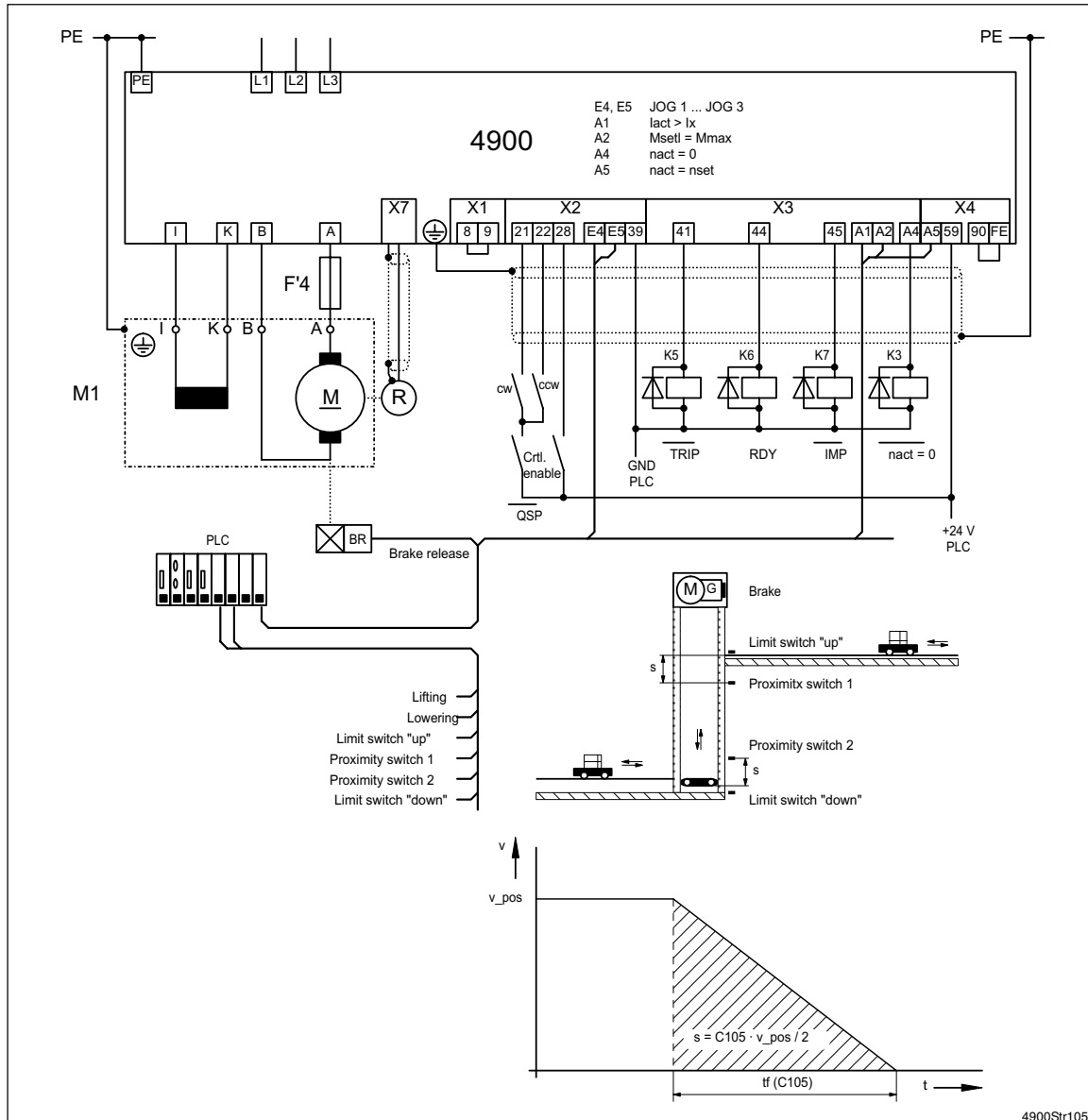
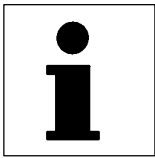

FIG 15-7 Connection diagram for hoiset

Bridge between terminals 8 and 9 sets a value of 100% n_{max} , if no JOG value is activated.



Selection aid

Parameter setting

Code	Input	Description
Input according to motor nameplate		
C083	xxx A	Rated field current
C084	xxx ms	Armature-time constant
C088	xxx A	Rated motor current
C090	xxx V	Rated motor voltage
Input of current limits		
C022, C023	xxx A	Maximum motor current
Enter controller configuration		
C000	-2-	Extended code set
C005	-52-	Speed control with phase controller
Adjustment of speed controller		
C070	V_{pn}	At high inertias, adapt n - controller gain
Adjustment of the phase controller		
C254	V_{pw}	Adapt V_{pw} to the system, if $V_{pw} = 0$, the phase controller is not activated.
Application parameters		
C011	xxx rpm	Enter max. speed (this speed corresponds to v_{max})
C019	xxx rpm	Set threshold $n_{act} = 0$
C240	xxx % n_{max}	Setting of the permissible speed deviation
C116	-5-	Input selection of the digital output A5
C128	xxx s	Time, during which the drive can leave the selected range, without a message being sent
C255	xxxx incr	Following error limit
C105	xxx s	Deceleration time $t_f = 2 \cdot s / v_{pos}$
C116	-1-	Input selection of the digital output A1
C117	-15-	$I_{act} > I_x$
C244	xxx %	I_{max} (limit value for the starting torque against the brake)
C038	-1-	Input selection JOG 1
C039	xxx %	C011 (save speed for v_{pos} in JOG 1)
C038	-x-	Input selection JOG x
C039	xxx %	C011 (other speeds)
Save parameter		
C003		Save parameter set

15.7 Speed-ratio synchronism

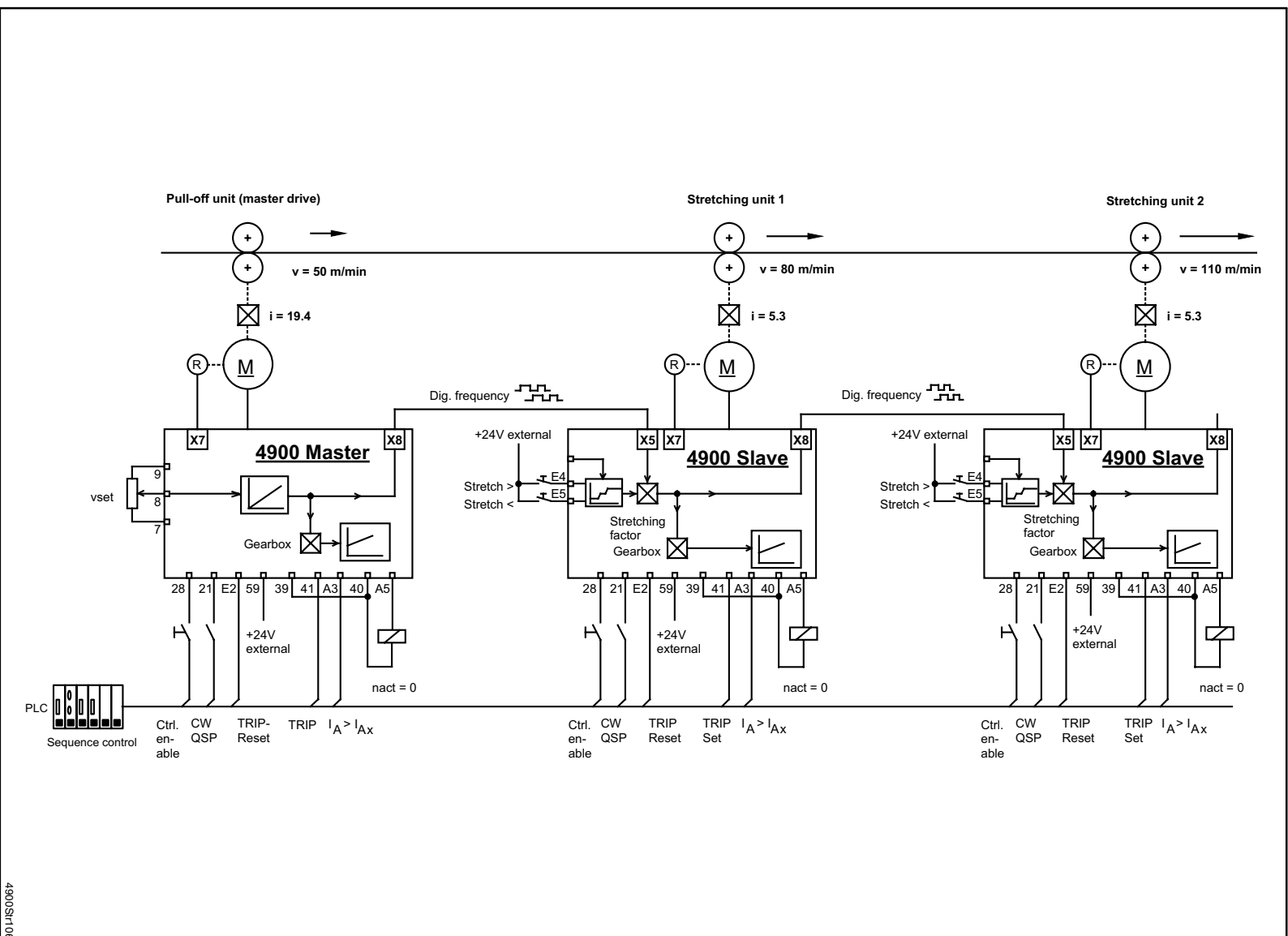
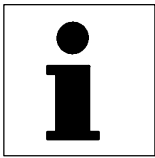

FIG 15-8 Connection diagram for speed-ratio synchronism

4900Sfr106





Selection aid

Parameter setting

Code	Input	Description
Input according to motor nameplate		
Master and slave		
C083	xxx A	Rated field current
C084	xxx ms	Armature-time constant
C088	xxx A	Rated motor current
C090	xxx V	Rated motor voltage
Input of current limits		
Master and slave		
C022, C023	xxx A	Maximum motor current
Enter controller configuration		
Master and slave		
C000	-2-	Extended code set
Master		
C005	-52-	Speed control with resolver
Slave		
C005	-72-	Set-value cascade with resolver
Freely assignable digital inputs		
Slave		
C112	-4-	Input selection E4
C113	-17-	Motor potentiometer down
C112	-5-	Input selection E5
C113	-18-	Motor potentiometer up
Freely assignable analog inputs		
Slave		
C145	- 8 -	Input selection motor potentiometer output
C146	-10-	Gain C027 of X5
Freely assignable digital outputs		
Master and slave		
C116	-5-	Input selection A5
C117	-15-	$I_A > I_{AX}$
Gearbox factor		
Master (FIG 15-8; i = 19.4)		
C032	xxx	Numerator = 1.9400
C033	xxx	Denominator = 0.1000
Slave (FIG 15-8; i = 5.3)		
C032	xxx	Numerator = 0.5300
C033	xxx	Denominator = 0.1000
Stretch factor		
Slave		
C027	xxx	Numerator = 1.6 (Stretching unit 1); Numerator = 1.375 (Stretching unit 2)
C028	xxx	Denominator = 1
Motor potentiometer parameter setting		
Slave		
C260	100%	Motor potentiometer upper limit
C261	-100%	Motor potentiometer lower limit
C262	xxx s	Motor potentiometer acceleration time
C263	xxx s	Motor potentiometer deceleration time

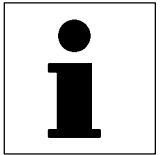

Code	Input	Description
Adjustment of speed controller		
Master and slave		
C011	xxxx rpm	Max. max. speed
Application parameters		
Master and slave		
C022, C023	xxx A	Maximum motor current
C019	xxxx rpm	Set threshold $n_{act} = 0$
C070	V_{pn}	At high inertias, adapt n - controller gain
C244	xxx %	$I_A > I_{Ax}$
Save parameter		
Master and slave		
C003		Save parameter set



15.8 Modular box 2215

15.8.1 Winding drive

Purpose

For winding applications, e.g. winding of a paper reel, the drive can be economically expanded as operator-friendly winding drive. For this, use the 2215 modular box. With this box, the winding drive can be individually adapted to many different applications. Variants, such as winding drive with terminals, InterBus, Beckhof bus or PROFIBUS are available. The parameters for the winding drive are set as physical units which makes the usually complicated adjustment no longer necessary.

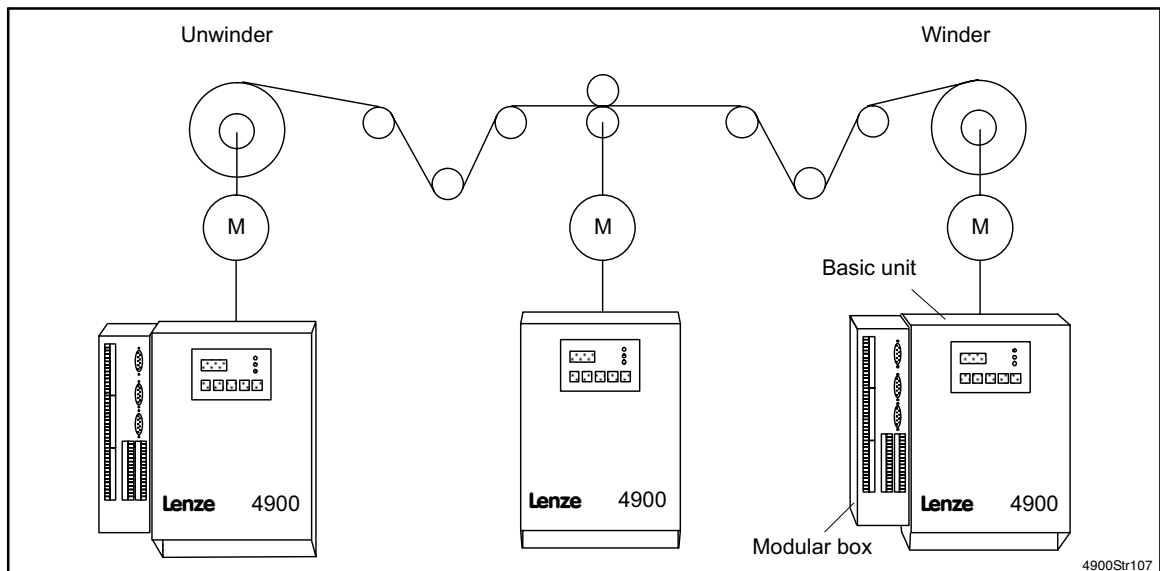

FIG 15-9 Drive system 48XX/49XX as winding application

With winding drives, the following functions are possible:

- Winding/unwinding from top or bottom

Torque controlled winding with determination of the winding characteristic as function or from a table with 16 values (here the diameter range of d_{\min} to d_{\max} is subdivided into 16 sections, the factor of the corresponding table position has an influence on the initial tension). The characteristic can be changed from 0% to 200%. This means:

- 0% = constant torque
- 100% = constant tension
- 200% = tension increase with larger diameters

These functions can be controlled via terminals.



Compensation of friction, acceleration and breakaway torque

The friction can be compensated as function or from a table with 16 values as function of the torque. The required acceleration torque can be adjusted by entering the material data (width and density) or via terminals. The breakaway torque can be added to the torque as offset percentage through an adjustable time (0 to 5 s).

Digital detection of speed and material speed

A conventional adjustment is not necessary. Simply enter the machine data such as minimum diameter, gearbox factors, maximum line speed, motor data according to nameplate, etc. The actual diameter, actual tension and actual torque, etc. are indicated in the corresponding codes. These values can also be read from an analog output.

Integrated tension controller

An integrated tension controller, which can be configured for tension measuring rollers or dancers, enable a constant tension according to a preselected set-value. With an analog output, this tension set-value as control signal can be used as variable for the dancer tension when being converted by an I-p converter (important for winding with characteristic). The output signal of the tension controller can be added to the torque or speed with or without diameter evaluation (adaptation of the tension controller with the diameter).

Tables

In addition to the tables for characteristic and friction, there are tables for 16 different initial diameters as well as 16 fixed set-values for circumferential speed (fixed set-values evaluated with the diameter).

Consideration of the dancer deflection

With diameter calculation, the dancer deflection can be considered as path change. By this, the dancer movement can reduce the positive feedback.

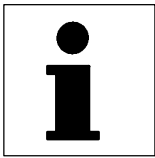

Digital, freely programmable inputs

- Ctrl. inhibit of the automation module
- Diameter calculation enable
- Initial diameter
- Winding or unwinding
- Winding from top or bottom
- Enable speed offset
- Changeover torque from calculated value to maximum value
- Enable tension controller
- Enable I component of the tension controller
- Activate web-break monitoring



Note!

For the winding drive explained above do not only observe the Operating Instructions 48XX/49XX but also the Operating Instructions "Winding calculator" (see register H).

15.8.2 Positioning drive

Purpose

Simple positioning tasks can be solved with the positioning drive. In many cases the PLC can be relieved or will not be necessary at all.

For this, use the 2215 modular box. With this box, the positioning drive can be individually adapted to many different applications. Variants, such as positioning drive with terminals, InterBus, Beckhof bus or PROFIBUS are available.

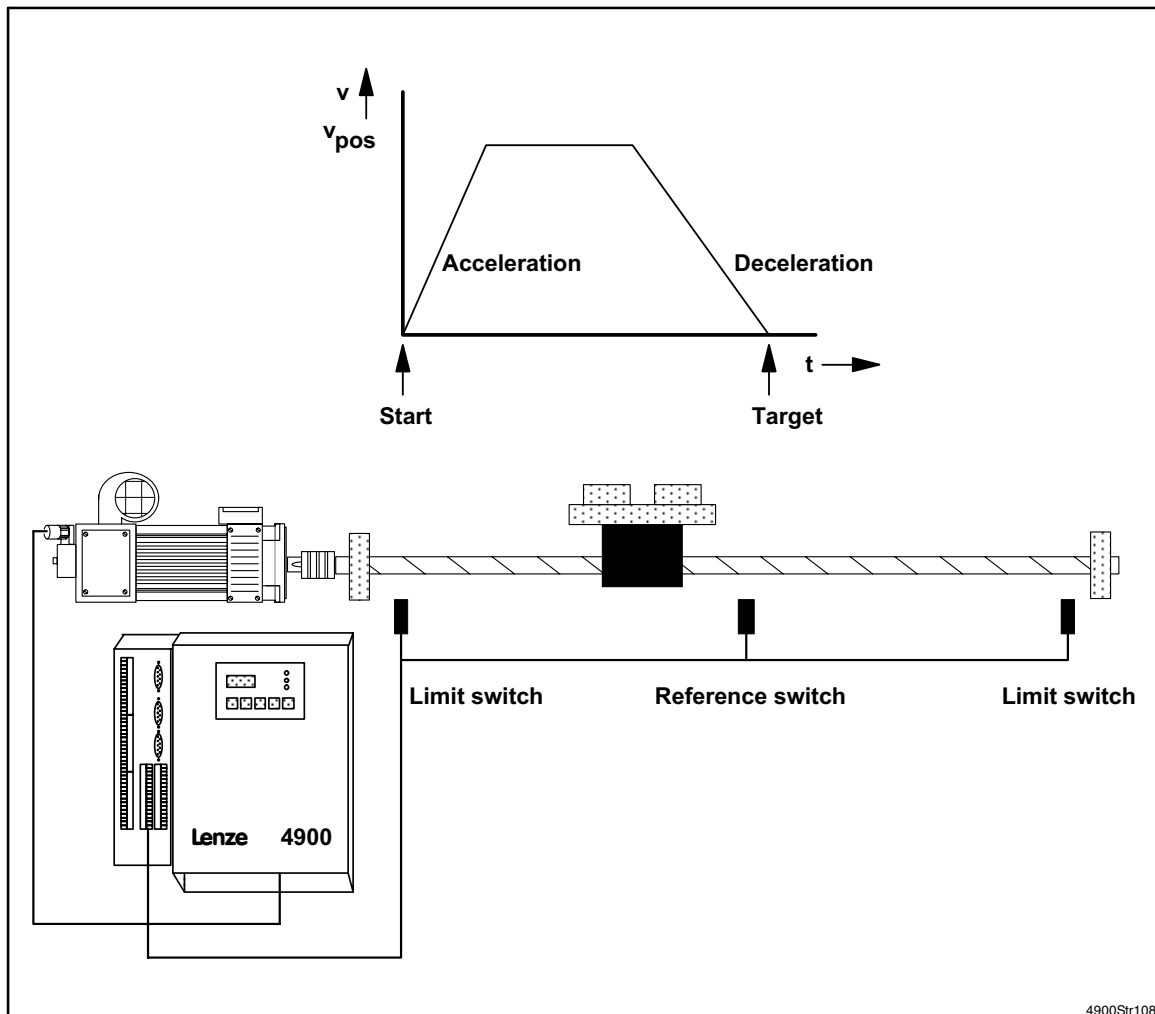
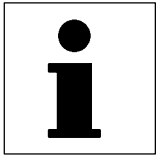

FIG 15-10 Drive system 48XX/49XX as positioning application

The following features are integrated into the positioning drive:

- 32 freely assignable digital input
of which, depending on the variant, 8 or 28 assignable via terminals
- 32 freely assignable digital outputs
of which, depending on the variant, 4 or 16 assignable via terminals
- Measuring system absolute or relative (endless incremental dimension)
- 32 program sets, each with the following functions:
 - Point-to-point positioning
 - Point-to-point positioning with changeover of velocity
 - Positioning with interrupt input
 - Acceleration, delay, travelling and final speed adjustable
 - Waiting for input
 - Switching of several outputs
 - Homing according to 6 different modes



Selection aid

- Adjustable waiting time
- Adjustable number for repetition function
- Limited program branching depending on the inputs
- Jump to the following program set
- 32 adjustable position targets
- 32 adjustable speeds
- 32 adjustable acceleration/deceleration values
- 32 adjustable number of pieces
- 32 adjustable waiting times
- Manual or program operation
- Inputs and displays via keypad and display of the basic unit
- Parameter setting and diagnostics via the serial interface LECOM-A/B of the basic unit and the PC program LEMOC2
- Connection of BCD switches
- Connection of an absolute value encoder
- Control, parameter setting and diagnostics via InterBus or Profibus possible (variant with fieldbus connection)



Note!

For the positioning drive explained above do not only observe the Operating Instructions 48XX/49XX but also the Operating Instructions "Positioning" (see register H).



15.9 Mains isolation

15.9.1 Tipping with mains isolation

In this application proposal, the power stage is connected to or separated from the mains through a tipp command (momentary-contact pushbutton S4). Since the control electronics and the field supply are ready for operation when the mains switch is on, the tipp command only delays the signal of the mains contactor.

Controller preparation:

- With controllers 4902...4907 (PCB 4902LP, 4903LP or 4905LP), remove the wire bridge between BR1, BR2, BR3, BR4 and BR5 when no voltage is applied.
- With controllers 4X08...4X13 (PCB 4908LP oder 4911LP), remove the bridges BR3, BR4 and BR5 when no voltage is applied.

To get to the bridges to be removed, observe the following steps:

- Open the controller cover (4 fixing screws)
- Loosen 2 screws fixing the flap of the control electronics
- Open flap



Stop!

- Ensure correct phase connection of mains supply. (Wrong connection leads to fuse tripping).
 - The phase angle of the voltages in power stage and control electronics must be lower than 2° electrically.
 - Before opening or closing the contactor K1, the controller must be inhibited via the function "controller enable". If this switching sequence is not observed, fuses may trip or the fault message ACI may be indicated.
 - In tipping operation with K1 the electronics remain supplied. The main switch separates the controller from the mains.
 - With this application, a voltage is continuously applied to the field. Activate standstill excitation (field heating)!
-

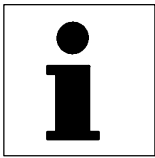

Selection aid

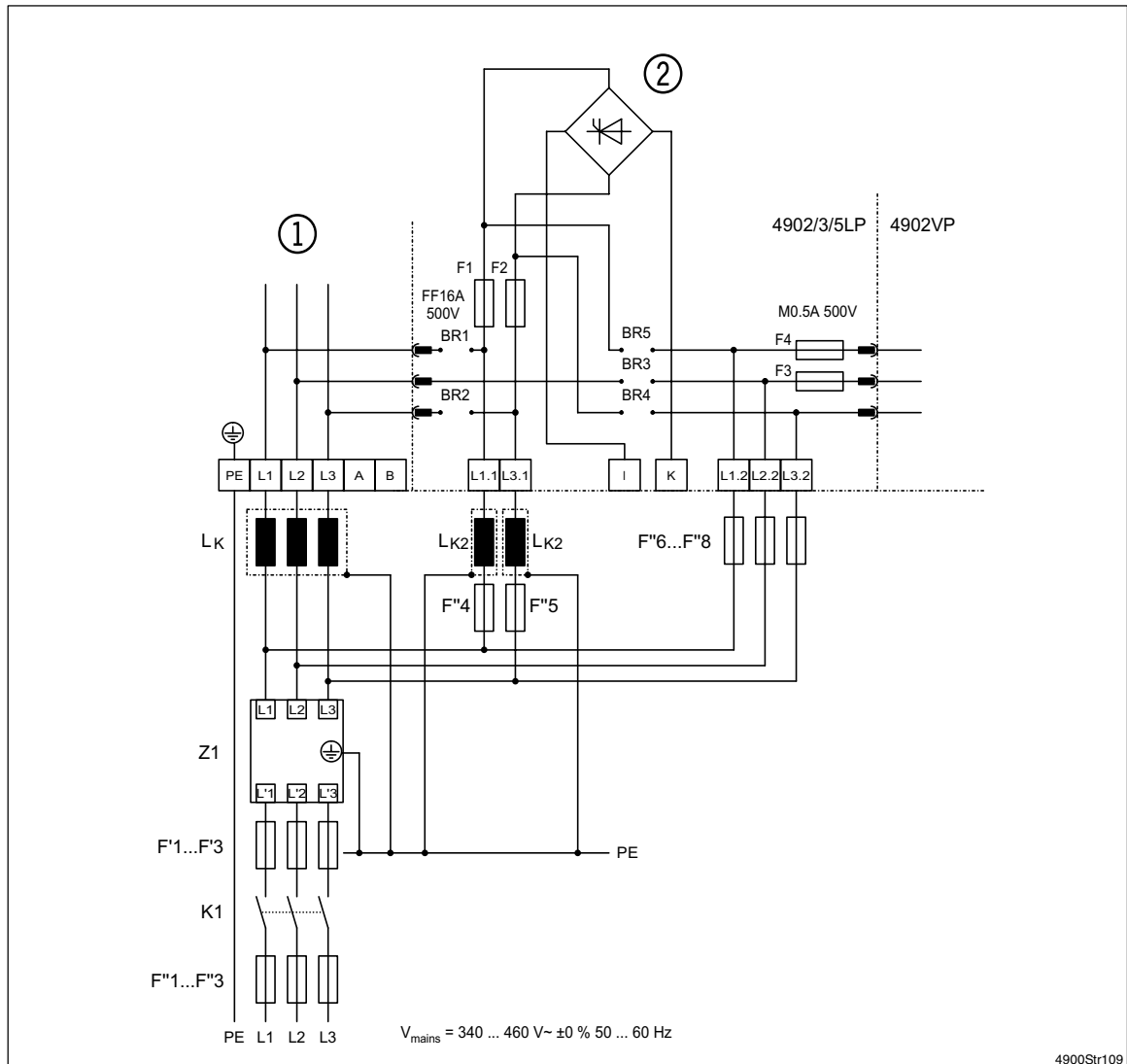
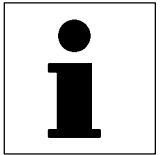

FIG 15-11 Power connection for tipping operation with mains isolation

Explanations

F'1...F'3	Semi-conductor fuses
F"6...F"8	Cable-protection fuses 4A
F"1...F"4	Cable-protection fuses
Q1	Main switch
K1	Mains contactor
①	Power stage
②	Field controller



Contactor or relay circuit

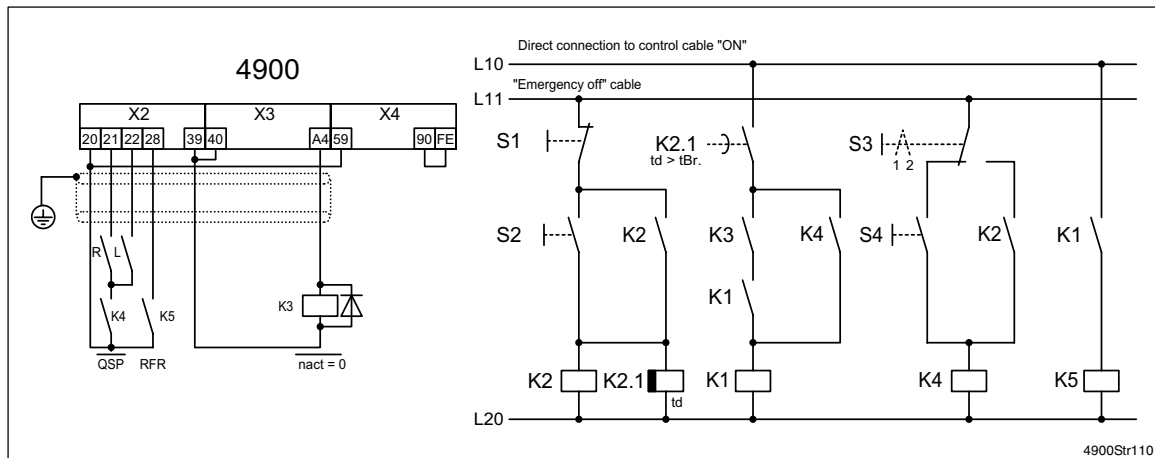

FIG 15-12 Connection of the signal electronics for tipping operation via momentary-contact pushbutton S4

K1	Controller mains contactor
K2.1	Safety relay for mains isolation if no standstill message is indicated
K4, K5	Relay with gold-plated contacts
S1	Drive off
S2	Drive on
S3	1: Tipping / 2: Automatic
S4	Inching
L10	Direct cable from the control cable 'on'
L11	'Emergency-Off cable'

15.9.2 Mains switch-off logic



Stop!

The controllers 48XX/49XX must only be separated from the mains when they are inhibited or the motor is in standstill.

This also applies to the emergency-off function.

The function $In_{act} < C019$ can be used for the mains switch-off logic.

The digital output terminal A4 is for automatic mains switch-off. The terminals sets "low", if the actual speed value is lower than the value set under C019. The threshold can be set under C019 from 0 to 5000 rpm. For this application, the setting must not exceed $2\% n_{rated}$.



Selection aid

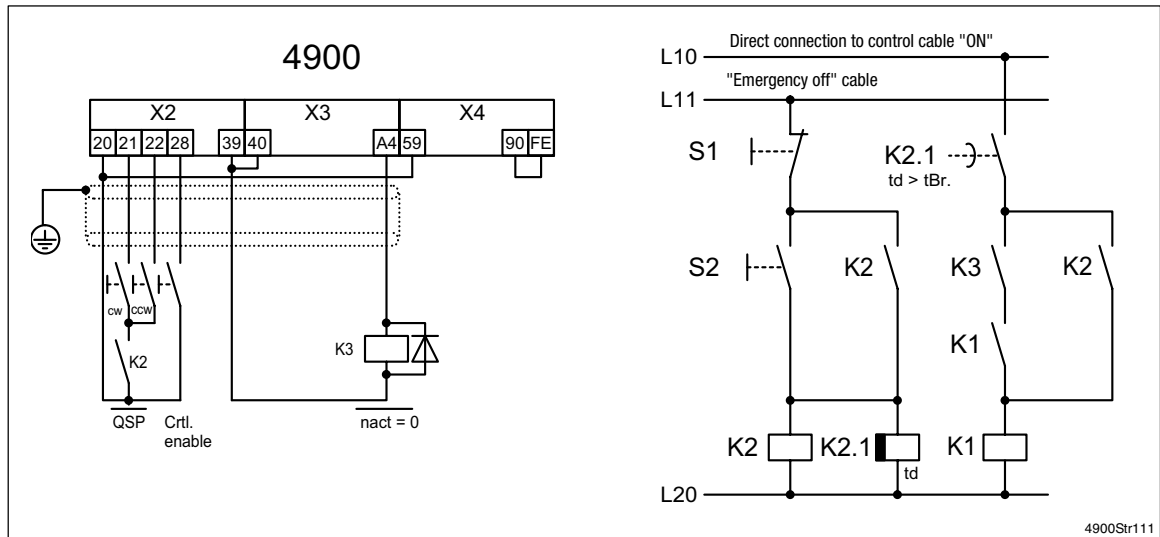
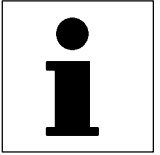
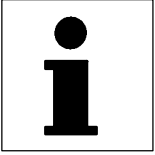

FIG 15-13 Example for fastest possible switch-off in inverter operation





Selection aid

EDS4900U--L
00408859

Manual

Part L

Signal-flow charts

DC speed controller
4800/4900

The features, data and versions indicated in this Manual met the state of the art at the time of printing.

(Printing date: inner cover pages of the parts).

In the event of deviations, please see the Operating Instructions or contact Lenze.

		revised	
Edition of:	01/03/1999		

16 Signal-flow charts

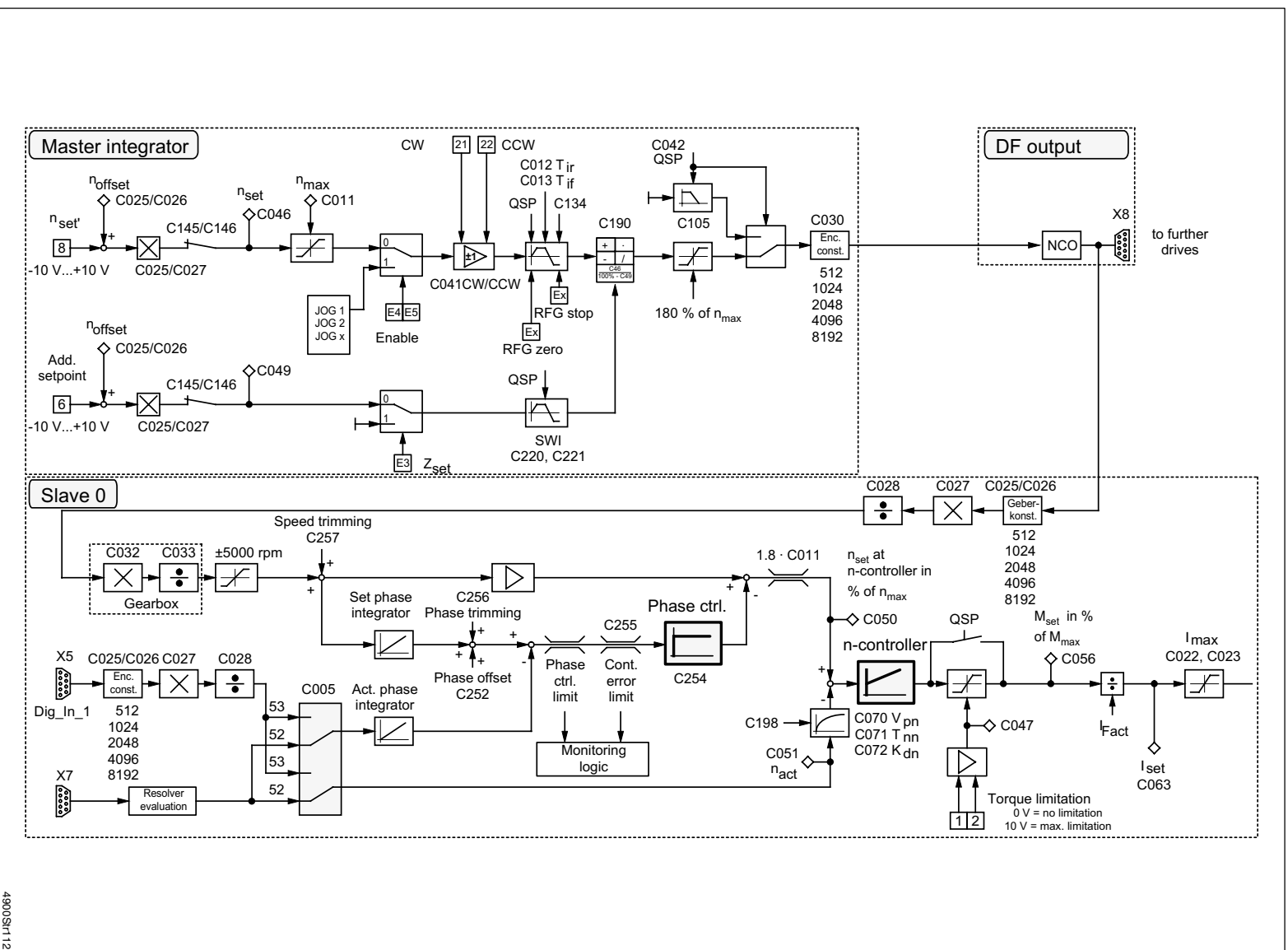

FIG 10-1 Signal-flow chart Master configuration C005 = -5X-

4900SH112

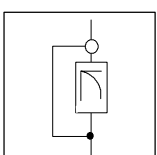
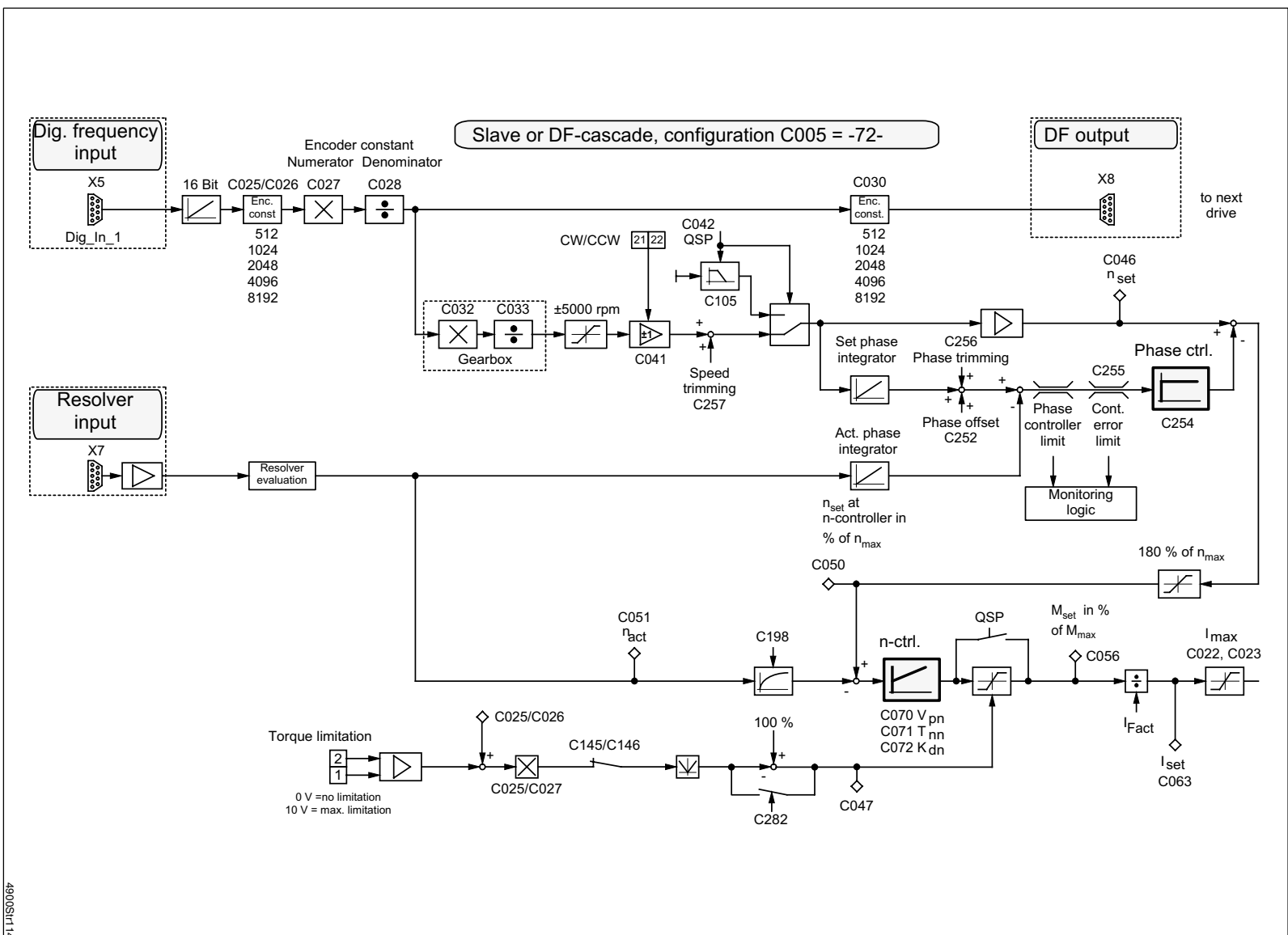
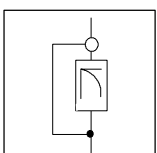
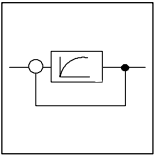

FIG 10-3 Signal-flow chart Configuration C005 = -72- (DF cascade)



4900SH114





Signal-flow charts

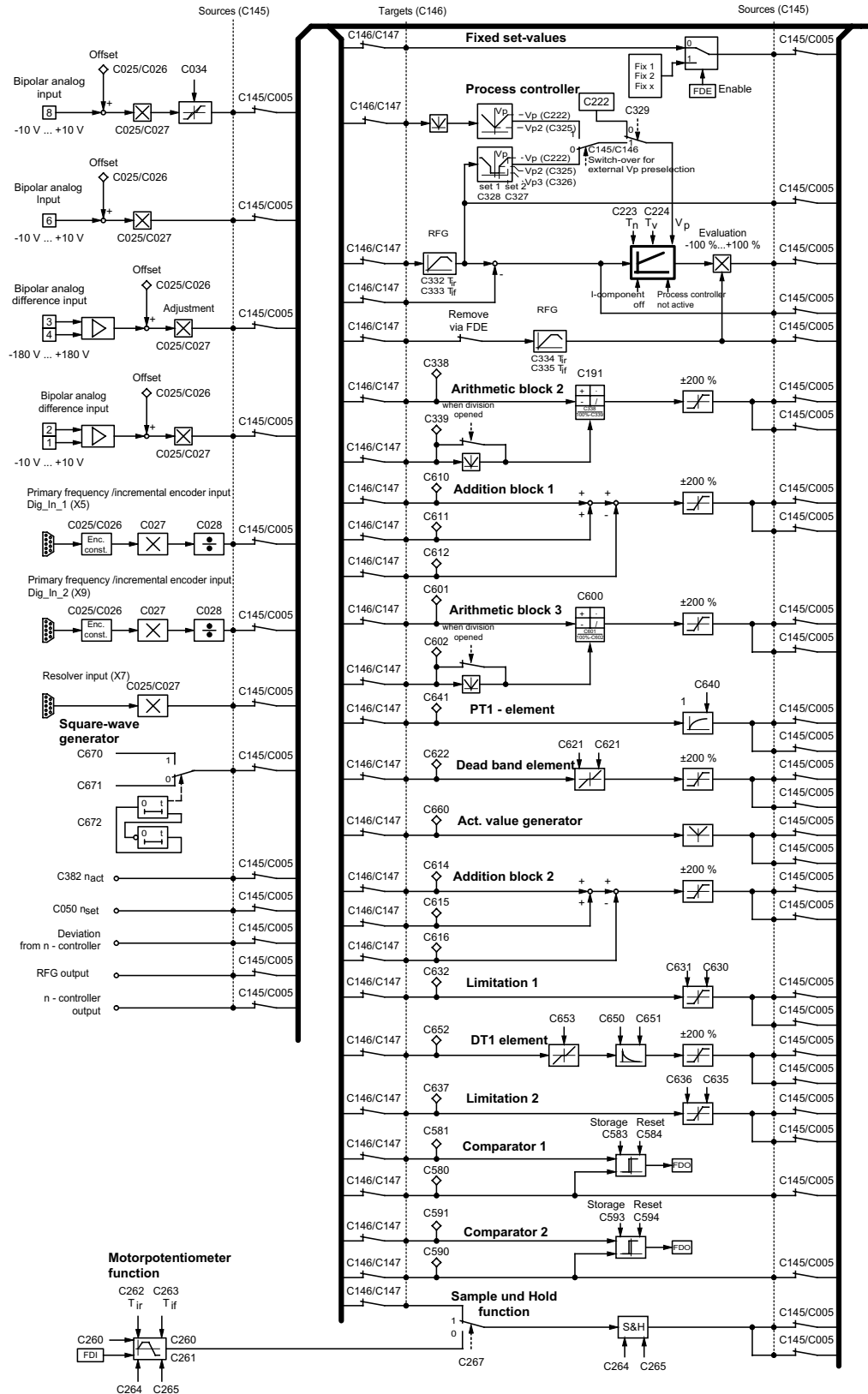

4900Str115a

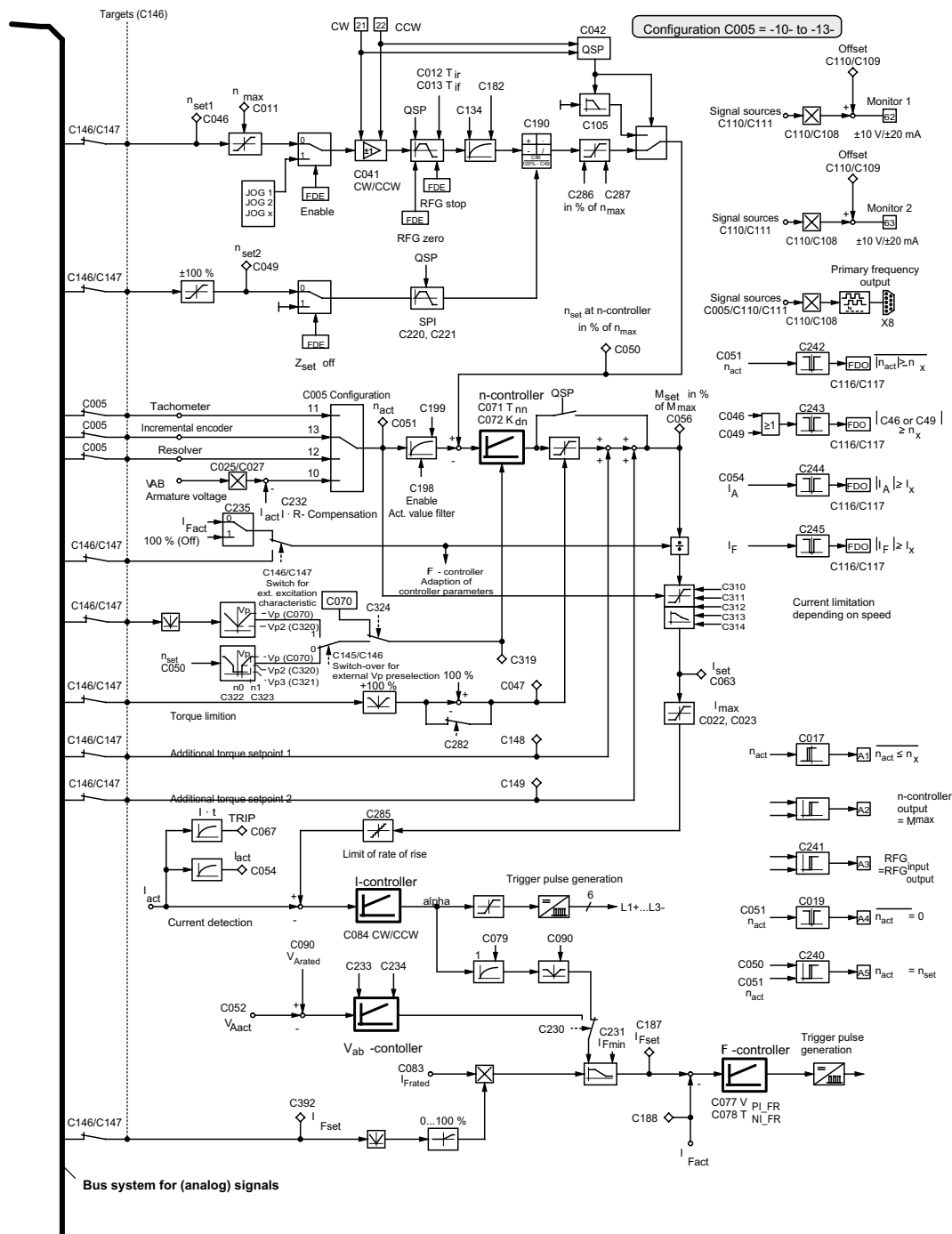
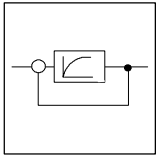

4900Str115b

FIG 10-4 Signal-flow chart Configuration C005 = -1X- (speed control)

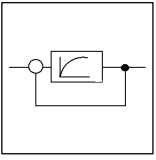

Signal-flow charts

EDS4900U--M
00408860

Manual

Part M

Glossary

Table of keywords

DC speed controller
4800/4900

The features, data and versions indicated in this Manual met the state of the art at the time of printing.

(Printing date: inner cover pages of the parts).

In the event of deviations, please see the Operating Instructions or contact Lenze.

		revised	
Edition of:	01/03/1999		

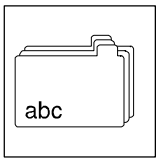

17 Glossary

Term	Meaning
AIF	Automation interface (X1)
CE	Communauté Européenne (English: European Community)
Code	For entry and display (access) of parameter values. Variable addressing according to the format "code/subcode" (Cxxx/xx). All variables can be addressed via the code digits.
Ctrl. enable	Controller enable
Ctrl. inhibit	Controller inhibit (= Controller enable ⁻)
FDI	freely programmable digital input
FDO	freely programmable digital output
Fieldbus	For data exchange between superimposed control and positioning control, e. g. InterBus or PROFIBUS.
Following error	Difference between current position set-value and position actual value.
Following error monitoring	Monitors the actual following error for exceeding the following error tolerance and, if necessary, sets a trip.
Following error tolerance	If the following error reaches a certain following error tolerance, a trip is set.
InterBus	Industrial communication standard to DIN E19258
JOG	Fixed speed or input for fixed speed
LECOM	Lenze Communication
LEMOC2	PC-program (DOS) for Lenze controllers
LF	Master frequency
LU	Undervoltage
Master	Masters are host systems, e.g. PLC or PC.
NCO	Numeric clock oscillator
OU	Overvoltage
PC	Personal Computer
PLC	Programmable logic controller
PM	Permanent magnet
Process data	For instance, setpoints and actual values of controllers which must be exchanged within a minimum of time. Process data are usually small amounts of data which are to be transmitted cyclically. For PROFIBUS, these data are transmitted in the logic data channel.
PROFIBUS	Communication standard DIN 19245, consisting of part 1, part 2 and part 3
QSP	Quick stop
RFG	Ramp function generator
SIO	Serial Input / Output
Slave	Bus participant which may only send after the request of the master. Controllers are slaves.
SSI	Synchronous serial interface
SVI	Set-value integrator (ramp function generator)

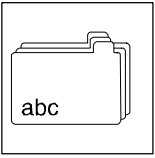

Glossary

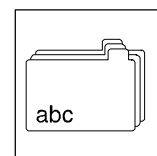

18 Table of keywords

0 ... 9

2Q operation, Change of the direction of rotation, 4-23

4Q/2Q operation, 7-60

A

A/D conversion, 7-29

Absolute value generator, 7-78

Acceleration, 7-19, 7-85

Acceleration and deceleration times, 7-6

Accessories

Fuses, 13-2

Mains chokes, 13-7

Networking, 13-15

RFI filter, 13-12

System cable, 13-10

Act. value, Adjustment of tacho voltage, 4-15

Actual speed, Filter, 7-94

Actual value

Adjustment of the tacho voltage, 7-11

Armature current, 4-16

Display, 12-5

Displays, 7-117

Feedback, 7-10

Actual value feedback, redundant actual value feedback, 7-55

Adaptation

Current controller, 7-14

Process controller, 7-68

Speed controller, 7-93

Addition, 7-81

Torque, Additional values, 7-89

Additional set-value, 7-12

Additional setpoint, 5-6

Additional value, 7-89

Additional set-value, 7-2

Adjustment

Field controller, 7-17, 7-18

Gain, 7-19

I*R compensation, 7-56

Offset, 7-19

Redundant actual value feedback, 7-56

Speed controller, 7-18

Ambient temperature, Operation, 3-1

Analog inputs and outputs, 4-14

Application as directed, 1-2

Application conditions, 3-3

Arithmetic blocks, 7-70

Armature choke, 14-3

Armature current

Actual-value display, 4-16

Monitoring, 7-28

Armature fuse, 13-4

Armature time constant, 7-14

Assembly space, 3-1

Automation module, Winding drive, 15-20

Auxiliary starting circuit, Field controller, 4-6

B

Baud rate, 4-26, 12-2

Brake control, 5-6, 7-62

C

Cable protection fuses, 13-3

Cable-protection fuses, 15-24

Cascading factor, 7-48

CE conformity, 1-4

CE-typical drive system, 4-29

Components, 4-30

Filters, 4-31

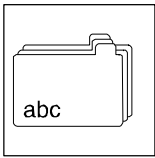

Index

- Grounding, 4-32
- Installation, 4-29
- IT mains, 4-4
- Screening, 4-31
- Signal cables, 4-31
- Cleaning, 9-1
- Code
 - Change, 7-113
 - Code table, 7-119
 - Input selection, 7-113
- Code level, 7-110
- Code set
 - Changeable, 7-117, 7-119
 - Display, 7-117
- Commissioning, 5-1
- Comparator, 7-86
- Compensation equipment, 4-4
- Condensation, 3-3
- Configuration
 - Armature voltage feedback, 7-10
 - Change, 5-8, 7-98
 - Digital frequency, 7-39
 - Incremental encoder feedback, 7-13
 - Resolver, 7-13
 - Tacho feedback, 7-11
- Connection
 - Incremental encoder, 4-22
 - Resolver, 4-21
- Control cables, Screening, 4-3
- Control module
 - Configuration switch, 7-4
 - Layout of the connections, 4-13
 - Switch for configuration, 4-13, 4-15
- Controller enable, 5-5
- D**
 - D/A conversion, 7-35
 - Dancer position control, 7-59
 - DC tacho, 7-11
 - Dead-band element, 7-84
 - Deceleration ramp
 - Motor potentiometer, 7-74
 - Process controller, 7-68
 - Quick stop, 5-6
- Declaration of conformity, Low-Voltage, 1-5
- Declaration of conformity, Electromagnetic compatibility, 1-7
- Digital frequency
 - Bar, 7-42
 - Cascade, 7-46
 - Coupling, 7-39
 - Normalization of the inputs, 7-30
 - Output, 7-35, 7-50
 - Output frequency, 5-10
 - Selection, 4-24
- Digital inputs and outputs, 4-17
- Digital output functions, 7-27
- Digital frequency, Output, 4-25
- Dimensions, Controller, 3-8
- Direction of rotation, 5-6
- Display functions, 7-117
- DRIVECOM agreement, 12-3
- DT1 element, 7-85
- E**
 - Earthing, 4-4
 - Group drives, 4-4
 - Mass loops, 4-4
 - EC Directive
 - Electromagnetic compatibility, 1-6
 - Considered standards, 1-7
 - Low-Voltage, 1-4
 - Machinery, 1-9
 - Electrical isolation, 4-2, 4-26
 - Mass loops, 4-4
 - Encoder emulation, 4-25
 - Excitation characteristic
 - External, 7-95
 - Internal, 7-16
- F**
 - Factory setting, 7-111

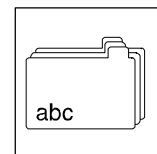

FAI, 7-29
Fault
 Cause, 8-4
 History buffer, 8-3
 Remedy, 8-4
 Reset, 12-1
Fault indication
 Display priority, 7-98
 Reset, 8-6
Fault message, 8-4
FDI, 7-22
FDO, 7-24
Features, Controller, 3-1
Field controller
 Field current monitoring, 7-28
 Mains chokes, 13-8
 Separate supply, 4-9
Field current reduction, 7-61
Field heating, 7-61
Field weakening operation, 7-15
Fieldbus connection
 InterBus, 4-27
 Interface enable, 12-3
 PROFIBUS, 4-28
Fixed set-value, 7-77
Following error, 7-54
Fuse, 13-2
 Holder, 13-5
 Internal, 13-5
Fuse holder, Dimensions, 13-5

G

Gain
 Adaption, 7-140
 Analog inputs, 7-20, 7-122
 Angle controller, 7-137
 Armature circuit, 7-14
 Field controller, 7-127
 Field current controller, 7-16
 Monitor outputs, 7-19
 Process controller, 7-136
 Speed controller, 7-18

Gases, 3-3
Gearbox, Limitation of rate of rise, 7-139
Gearbox factor, 7-39
 Digital frequency cascade, 7-48
 Fixed set-values, 7-77
 Speed-synchronous running, 7-51
Ground, Earth loops, 8-4
Grounding, 4-32
 RFI filter, 4-29

H

History buffer, 8-3
Hoist, 4-20
Hoists, Overspeeds, 2-3
Holding brake, 7-62

I

I component
 Process controller, 7-67, 7-69
 Quick stop, 7-63
 Speed controller, 7-18
Identification, 7-118
IMP, 7-109, 8-2
Incremental encoder
 Connection, 4-22
 Monitoring, 4-23
 Parameter setting, 7-13
 Supply, 4-23
Input of the direction of rotation, 7-37, 7-45, 7-48
Inputs
 Analog, 4-15
 Digital, 4-19
 FAI, 7-29
 FDI, 7-22
 Free assignable analog, 7-29
 Freely assignable digital, 7-22
 Freely assignable, analog, 5-9
 Freely assignable, digital, 5-8
Instability
 Armature circuit, 7-14

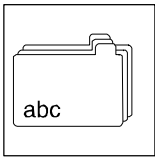

Index

- Field controller circuit, 7-15, 7-16, 7-17
- Speed, 7-94
- Installation
 - CE-typical drive system, 4-29
 - Connection, 4-5
 - Electrical, 4-2
 - Installation height, 3-3
 - Mechanical, 3-1
- Integral action time
 - Field controller, 7-16, 7-127
 - Speed controller, 7-18
- InterBus, Interface module, 4-27
- InterBus
 - Enable, 12-3
 - Interface, 12-1
- IT mains, 4-4
- J**
- JOG
 - Enable, 7-3, 7-4
 - Set-values, 7-2
- K**
- Keypad
 - Input selection, 7-113
 - Operation, 7-111
- L**
- Labelling, 1-1, 1-2
- Language, 3-1, 7-117
- LECOM
 - Code, Fault reset, 12-1
 - Interface, Code bank, 12-2
- LECOM code
 - FDI, 7-23
 - FDO, 7-25
 - High precision set-value display, 12-5
- LECOM-A/B, 4-26
 - Interface, 12-1
 - Networking, 4-26
- LECOM1, 4-26, 12-1
 - Baud rate, 12-2
 - Controller address, 12-1
- LECOM2, Interface, 12-1
- Level converter, 4-26, 13-15
- Liability, 1-3
- Limitation
 - Armature voltage, 7-16
 - Limitation elements, 7-79
 - N dependent armature current limitation, 7-90
 - Speed set-value, 7-9, 7-11
- Limitation elements, 7-79
- M**
- Main set-value, 7-2
 - Addition, 7-14
 - JOG set-values, 7-2
 - Adjustment, 7-11
 - Motor potentiometer, 7-73
 - Ramp function generator, 7-6
- Mains
 - Conditions, 4-4, 7-105
 - Monitoring, 7-105
 - Synchronisation, 7-105
 - Types, 4-4
- Mains chokes, 13-7
- Mains fuses, 13-3
- Mains switch-off, 7-27
- Mains voltage, 3-4, 8-4
 - 400 V, 3-4
 - 500 V, 3-6
 - Monitoring, 7-105
- Maintenance, 9-1
- Manufacturer's Declaration, Machinery, 1-9
- Master, 7-40, 7-50
- Master current, 4-15
- Master voltage, 4-15
- Message
 - Display priority, 7-98
 - Fault, 8-4
 - LED state display, 7-109
- Monitor
 - Changeover current/voltage, 4-16
 - Outputs, 4-16

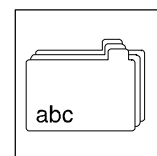

- Parameter setting, 7-33
 - Monitoring functions, 7-96
 - Change, 7-96
 - Display priority, 7-98
 - I(2)xt monitoring, 7-101
 - Ixt monitoring, 7-100
 - Message, 7-97
 - Possible assignments, 7-97
 - Trip, 7-96
 - Warning, 7-96
 - Monitoring functions
 - Following error, 7-54
 - Phase controller limit, 7-53
 - Motor
 - Armature time constant, 7-14
 - Armature time constants, 5-4
 - Blocking protection, 7-103
 - Checking, 8-7
 - Connection, 4-5
 - Motor data input, 5-4
 - Overload monitoring, 7-101
 - Voltage limitation, 7-16
 - Motor potentiometer, 7-73
 - Control, 7-74
 - Deactivation function, 7-74
 - Memory function, 7-75
- ## N
- Networking, Accessories, 13-15
 - Noise immunity, 3-3
- ## O
- Offset
 - Adjustment of analog inputs, 7-19
 - Adjustment of monitor outputs, 7-33
 - Speed synchronism, 7-51
 - Operating unit, 7-109, 7-118
 - Operating modes, 7-116
 - Operation
 - Control mode 4Q/2Q, 7-60
 - Operating state, 12-1
 - Speed controlled operation, 7-1
 - State, 7-126
 - Torque controlled, 7-37
 - With host connection, 4-26
 - Operator's safety, 4-2
 - Optical fibres, 13-15
 - Outputs
 - Analog, 4-16
 - Delay time, 7-24
 - Digital, 4-19
 - FDO, 7-24
 - Freely assignable analog, 7-33
 - Freely assignable digital, 7-24
 - Freely assignable, analog, 5-10
 - Freely assignable, digital, 5-9
 - Fuse monitoring, 4-20
 - Relay, 4-20
 - Overload
 - Controller, 7-100
 - Monitoring, 7-101
 - Motor, 7-101
 - Overtemperature, 7-126
- ## P
- Parameter, 7-110
 - Change, 7-111
 - Channel, 12-3
 - Fault, 7-97
 - Input selection, 7-113
 - Parameter level, 7-110
 - Parameter set
 - Change, 7-57
 - Dancer position control, 7-59
 - Load, 7-58, 7-114
 - Store, 7-114
 - Parameter setting, 7-108
 - Password protection, 7-115
 - Peripherals
 - Interface module 2110IB, 4-27
 - Interface module 2130IB, 4-28
 - Level converter 2101IB, 4-26
 - Phase
 - Controller, 7-53
 - Controller limit, 7-53
 - Synchronisation, 7-52
 - Trimming, 7-54

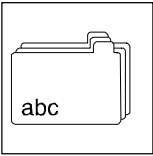

Index

Power connection, Standard controller, 4-6

Power derating, 3-1

Process controller, 7-67

Inputs, 7-68

Outputs, 7-69

Process data channel, 12-3

PROFIBUS, 12-3

Enable, 12-3

PT1 element, 7-80

Pulse inhibit

Change of the monitoring, 7-96

Message, 8-2

Q

QSP, 5-6

Qualified personnel, 2-2

Quick stop, 4-19, 5-6

Brake control, 7-62

Code set, 7-123

Possible configuration, 5-7

With activated phase controller, 7-53

R

Ramp function generator, 7-2, 7-68

Additional set-value, 7-2

Main set-value, 7-2, 7-6

Motor potentiometer, 7-74

Process controller, 7-67

S-shaped, 7-94

Rated data, 3-4

Armature voltage, 3-4, 7-60

Ratio, 7-123

RDY, 7-109, 8-2

Ready for operation, Message, 8-2

Redundant actual value feedback, 7-55

Relative humidity, 3-3

Relay output, 4-20

Reset, Fault indication, 8-6

Residual hazards, 2-3

Resolver, 4-21, 7-13

Encoder emulation, 4-25

Rotor position, 7-54, 7-124

RS232/485, 4-26, 12-1

S

S&H (Sample and Hold), 7-75

S-shaped ramp function generator, 7-94

Safety information

General, 2-3

Icons, 2-4

Scope of delivery, 1-1

Screening

Control and signal cable, 4-3, 4-31

Power connections, 4-30

Set-value

Additional set-value, 7-2

Bar, 7-42

Cascade, 7-46

Digital frequency coupling, 7-39

FIXED set-values, 7-77

Gain adjustment, 7-19

JOG, 7-2

Limitation, 7-9, 7-11

Main set-value, 7-2

Master current, 7-4

Motor potentiometer, 7-73

Process controller, 7-67, 7-68

Selection, 7-1

Setting range, 7-14

Torque control, 7-37

Torque set-value, 7-89

Setting range

Current, 3-1

Speed, 14-4

Signal-flow chart

Armature current limitation, 7-90

Speed set-value selection, 7-1, 7-9

Torque control, 7-38

Vdown control, 7-18

Vdown limitation, 7-17

Signal-flow charts, 16-1

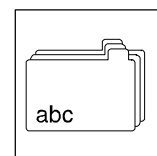

- Signals
 - Analog connection, 4-14
 - Connection of digital, 4-17
 - Single drives, 4-4
 - Slave, 7-42
 - Digital frequency bar, 7-42
 - Digital frequency cascade, 7-46
 - Software version, 7-128
 - Speed
 - Accuracy, 3-1
 - Automatic adjustment, 7-11
 - Controller adaptation, 7-93
 - Limitation, 7-89
 - Maximum speed, 7-14
 - Monitoring, 7-27
 - Ratio synchronism, 7-51
 - Set-value limitation, 7-9
 - Setting range, 3-1
 - Synchronism, 7-51
 - Synchronous running, 7-51
 - Trimming, 7-53
 - Speed control
 - With additional set-value, 7-1
 - With armature voltage feedback, 7-10
 - With incremental encoder, 7-13
 - With resover feedback, 7-13
 - With tacho feedback, 7-11
 - Speed controller, 7-18
 - Adaptation, 7-93
 - Speed fields, With armature voltage feedback, 7-10
 - Square-wave generator, 7-83
 - Standard
 - Considered, 1-5, 1-7
 - IEC 364, 2-1, 2-2
 - Degree of pollution, 3-3
 - DIN 40050, 3-3
 - DIN 42017/VDE 0530 part 8, 4-5
 - DIN 43673, 4-5
 - DIN VDE 0100, 1-5, 2-1
 - DIN VDE 0110, 1-5, 2-1, 3-3
 - DIN VDE 0110 VBG 4, 2-1
 - DIN VDE 0160, 1-5, 2-1
 - DIN VDE 0530/8, 4-5
 - DIN VDE 0558, 2-1
 - DIN VDE 0660 part 500, 2-1
 - EN 50081-2, 3-3
 - EN 50082-2, 1-7
 - EN 55011, 1-7, 3-3
 - EN 60097, 1-5
 - EN 60146, 2-1
 - EN 60439-1, 2-1
 - EN 60529, 1-5
 - EN 61000-4-2, 1-8, 3-3
 - EN 61000-4-4, 1-8, 3-3
 - EN 61000-4-5, 1-8, 3-3
 - EN 61800-3, 1-7
 - ENV 50140, 1-8
 - IEC 1000-4-3, 1-8, 3-3
 - IEC 22G, 3-3
 - IEC 249, 1-5
 - IEC 326, 1-5
 - prEN 50178, 2-1
 - VDE0220, 4-5
 - Standards, 2-1
 - Standstill excitation, 7-61
 - Supply
 - Separate, control electronics, 4-11
 - Separate, field-current bridge, 4-9
 - Switch-on display, 7-118
 - System cable, 13-10
 - Digital frequency coupling, 13-11
 - Incremental encoder, 13-11
 - Resolver, 13-10
 - System fault, 7-97, 8-4
- ## T
- Table of attributes, 7-145
 - Tacho
 - Adjustment, 7-11
 - Rated voltages, 4-21
 - Technical data, 3-1
 - Dimensions, 3-8
 - Electrical data, 3-4
 - General data/application conditions, 3-3
 - Temperature
 - Heat sink, 8-4
 - Motor, 7-101
 - Storage and transport, 3-3

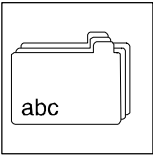

Index

Terminals

- Changing the signal assignment, 5-8
- Control connections, 4-13
- Type of operation, 7-116

Torque

- Controlled operation, 7-37
- Reduction, 7-4

Trip

- Controller inhibit, 5-5
- Display priority, 7-98
- LED state display, 7-109
- Operating state, 12-2
- Phase controller limit, 7-53
- Reset, 8-6, 12-1

Troubleshooting, 8-1

- Cause, 8-4

V

Vab control, 7-18

Vab limitation, 7-16

Variant design

- V011 InterBus, 4-27
- V013 PROFIBUS, 4-28

Variants, V014 500V mains voltage, 3-6

W

Warning

- Display priority, 7-98
- Redundant actual value feedback, 7-56

Warranty, 1-3

Waste disposal, 1-3

Z

Zero track, 7-124

- Actual phase output, 12-5
- Digital frequency output, 7-36

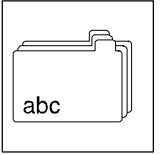

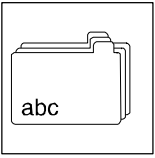

Index