



LSMV

**Enclosed asynchronous three-phase motors
for speed variation**

Aluminium alloy housing - 0.18 to 132 kW

Technical catalogue

LSMV: THE VARIABLE SPEED SOLUTION FOR ALL APPLICATIONS

Placed at the heart of the processes, asynchronous motors are increasingly being controlled by variable speed drives. The main reasons are to save energy, to provide adaptability to fulfil needs of diverse applications and to enhance performance of machines to which they are coupled.

These operating requirements demand high performance motors which can guarantee sufficient torque over the entire speed range without experiencing deficiency in thermal and dielectric capacities.

Leroy-Somer has integrated these requirements into the basic design of LSMV range with performance level unique to meet the most arduous of applications.

■ CONSTANT TORQUE from 5 to 50 Hz



The variable speed motor solution with no derating or forced ventilation:

■ INTERCHANGEABILITY GUARANTEED

Mechanically identical to an IEC fixed speed motor with the same power

■ SIMPLICITY

Operates without forced ventilation so no additional supply needed.

LSMV Range

- Asynchronous three-phase aluminium housing motors
- Power: 0.18 to 132 kW
- Torque: 0.8 to 880 N.m
- Speed: 0 to 6000 min⁻¹
- Can be used with different control methods: scalar V/F, vector open or closed loop

LSMV: THE VARIABLE SPEED SOLUTION FOR ALL APPLICATIONS

In order to meet the requirements for combined operation with variable speed drives, the LSMV motor design incorporates a whole host of options, from the most simple to the most complicated:

■ Thermal monitoring for total motor protection

- positive temperature coefficient thermistors (PTC)
- thermostat normally open PTO or normally closed PTF
- thermocouples, thermal sensors PT100, KTY

■ Speed feedback by single turn of incremental encoder

- resolution of 256 ppts to 4096 pulses (other resolutions on request)
- electrical supply: 5 Vdc or 11/30 Vdc
- output 5 Vdc TTL compatible with RS422 or HTL 11-30 Vdc push pull



■ Speed feedback by single turn or multi-turn of absolute encoder

- resolution 4096 to 8192 ppts
- electrical supply 5 Vdc or 11-30 Vdc
- interface SSI, Biss, EnDat®, Hiperface® or bus



■ Hold on position or braking at end of cycle

- fail safe brakes
- braking torque from 8 to 80 N.m
- supply voltage 230 or 400 V / 1ph (195 VDC coil)



Enclosed three-phase asynchronous motors for speed variation LSMV

Sélection

IP 55 - 50 Hz - Classe F - Réseau 400 V - Couplage du moteur Y 400 V - 51

LSMV name option

Modèle	4 pôles (1500 tr/min)	6 pôles (1000 tr/min)	8 pôles (750 tr/min)
LSMV P1.5	0.37	0.55	0.75
LSMV P2.2	0.55	0.75	1.1
LSMV P3.0	0.75	1.1	1.5
LSMV M1.5	1.5	2.2	3.0
LSMV M2.2	2.2	3.0	4.0
LSMV M3.0	3.0	4.0	5.5
LSMV M4.0	4.0	5.5	7.5
LSMV M5.5	5.5	7.5	11
LSMV M7.5	7.5	11	15
LSMV M11	11	15	22
LSMV M15	15	22	30
LSMV M22	22	30	40
LSMV M30	30	40	55
LSMV M40	40	55	75
LSMV M55	55	75	110
LSMV M75	75	110	150
LSMV M110	110	150	220
LSMV M150	150	220	300
LSMV M220	220	300	400
LSMV M300	300	400	550
LSMV M400	400	550	750
LSMV M550	550	750	1100
LSMV M750	750	1100	1500
LSMV M1100	1100	1500	2200
LSMV M1500	1500	2200	3000
LSMV M2200	2200	3000	4000
LSMV M3000	3000	4000	5500
LSMV M4000	4000	5500	7500
LSMV M5500	5500	7500	11000
LSMV M7500	7500	11000	15000
LSMV M11000	11000	15000	22000
LSMV M15000	15000	22000	30000
LSMV M22000	22000	30000	40000
LSMV M30000	30000	40000	55000
LSMV M40000	40000	55000	75000
LSMV M55000	55000	75000	110000
LSMV M75000	75000	110000	150000
LSMV M110000	110000	150000	220000
LSMV M150000	150000	220000	300000
LSMV M220000	220000	300000	400000
LSMV M300000	300000	400000	550000
LSMV M400000	400000	550000	750000
LSMV M550000	550000	750000	1100000
LSMV M750000	750000	1100000	1500000
LSMV M1100000	1100000	1500000	2200000
LSMV M1500000	1500000	2200000	3000000
LSMV M2200000	2200000	3000000	4000000
LSMV M3000000	3000000	4000000	5500000
LSMV M4000000	4000000	5500000	7500000
LSMV M5500000	5500000	7500000	11000000
LSMV M7500000	7500000	11000000	15000000
LSMV M11000000	11000000	15000000	22000000
LSMV M15000000	15000000	22000000	30000000
LSMV M22000000	22000000	30000000	40000000
LSMV M30000000	30000000	40000000	55000000
LSMV M40000000	40000000	55000000	75000000
LSMV M55000000	55000000	75000000	110000000
LSMV M75000000	75000000	110000000	150000000
LSMV M110000000	110000000	150000000	220000000
LSMV M150000000	150000000	220000000	300000000
LSMV M220000000	220000000	300000000	400000000
LSMV M300000000	300000000	400000000	550000000
LSMV M400000000	400000000	550000000	750000000
LSMV M550000000	550000000	750000000	1100000000
LSMV M750000000	750000000	1100000000	1500000000
LSMV M1100000000	1100000000	1500000000	2200000000
LSMV M1500000000	1500000000	2200000000	3000000000
LSMV M2200000000	2200000000	3000000000	4000000000
LSMV M3000000000	3000000000	4000000000	5500000000
LSMV M4000000000	4000000000	5500000000	7500000000
LSMV M5500000000	5500000000	7500000000	11000000000
LSMV M7500000000	7500000000	11000000000	15000000000
LSMV M11000000000	11000000000	15000000000	22000000000
LSMV M15000000000	15000000000	22000000000	30000000000
LSMV M22000000000	22000000000	30000000000	40000000000
LSMV M30000000000	30000000000	40000000000	55000000000
LSMV M40000000000	40000000000	55000000000	75000000000
LSMV M55000000000	55000000000	75000000000	110000000000
LSMV M75000000000	75000000000	110000000000	150000000000
LSMV M110000000000	110000000000	150000000000	220000000000
LSMV M150000000000	150000000000	220000000000	300000000000
LSMV M220000000000	220000000000	300000000000	400000000000
LSMV M300000000000	300000000000	400000000000	550000000000
LSMV M400000000000	400000000000	550000000000	750000000000
LSMV M550000000000	550000000000	750000000000	1100000000000
LSMV M750000000000	750000000000	1100000000000	1500000000000
LSMV M1100000000000	1100000000000	1500000000000	2200000000000
LSMV M1500000000000	1500000000000	2200000000000	3000000000000
LSMV M2200000000000	2200000000000	3000000000000	4000000000000
LSMV M3000000000000	3000000000000	4000000000000	5500000000000
LSMV M4000000000000	4000000000000	5500000000000	7500000000000
LSMV M5500000000000	5500000000000	7500000000000	11000000000000
LSMV M7500000000000	7500000000000	11000000000000	15000000000000
LSMV M11000000000000	11000000000000	15000000000000	22000000000000
LSMV M15000000000000	15000000000000	22000000000000	30000000000000
LSMV M22000000000000	22000000000000	30000000000000	40000000000000
LSMV M30000000000000	30000000000000	40000000000000	55000000000000
LSMV M40000000000000	40000000000000	55000000000000	75000000000000
LSMV M55000000000000	55000000000000	75000000000000	110000000000000
LSMV M75000000000000	75000000000000	110000000000000	150000000000000
LSMV M110000000000000	110000000000000	150000000000000	220000000000000
LSMV M150000000000000	150000000000000	220000000000000	300000000000000
LSMV M220000000000000	220000000000000	300000000000000	400000000000000
LSMV M300000000000000	300000000000000	400000000000000	550000000000000
LSMV M400000000000000	400000000000000	550000000000000	750000000000000
LSMV M550000000000000	550000000000000	750000000000000	1100000000000000
LSMV M750000000000000	750000000000000	1100000000000000	1500000000000000
LSMV M1100000000000000	1100000000000000	1500000000000000	2200000000000000
LSMV M1500000000000000	1500000000000000	2200000000000000	3000000000000000
LSMV M2200000000000000	2200000000000000	3000000000000000	4000000000000000
LSMV M3000000000000000	3000000000000000	4000000000000000	5500000000000000
LSMV M4000000000000000	4000000000000000	5500000000000000	7500000000000000
LSMV M5500000000000000	5500000000000000	7500000000000000	11000000000000000
LSMV M7500000000000000	7500000000000000	11000000000000000	15000000000000000
LSMV M11000000000000000	11000000000000000	15000000000000000	22000000000000000
LSMV M15000000000000000	15000000000000000	22000000000000000	30000000000000000
LSMV M22000000000000000	22000000000000000	30000000000000000	40000000000000000
LSMV M30000000000000000	30000000000000000	40000000000000000	55000000000000000
LSMV M40000000000000000	40000000000000000	55000000000000000	75000000000000000
LSMV M55000000000000000	55000000000000000	75000000000000000	110000000000000000
LSMV M75000000000000000	75000000000000000	110000000000000000	150000000000000000
LSMV M110000000000000000	110000000000000000	150000000000000000	220000000000000000
LSMV M150000000000000000	150000000000000000	220000000000000000	300000000000000000
LSMV M220000000000000000	220000000000000000	300000000000000000	400000000000000000
LSMV M300000000000000000	300000000000000000	400000000000000000	550000000000000000
LSMV M400000000000000000	400000000000000000	550000000000000000	750000000000000000
LSMV M550000000000000000	550000000000000000	750000000000000000	1100000000000000000
LSMV M750000000000000000	750000000000000000	1100000000000000000	1500000000000000000
LSMV M1100000000000000000	1100000000000000000	1500000000000000000	2200000000000000000
LSMV M1500000000000000000	1500000000000000000	2200000000000000000	3000000000000000000
LSMV M2200000000000000000	2200000000000000000	3000000000000000000	4000000000000000000
LSMV M3000000000000000000	3000000000000000000	4000000000000000000	5500000000000000000
LSMV M4000000000000000000	4000000000000000000	5500000000000000000	7500000000000000000
LSMV M5500000000000000000	5500000000000000000	7500000000000000000	11000000000000000000
LSMV M7500000000000000000	7500000000000000000	11000000000000000000	15000000000000000000
LSMV M11000000000000000000	11000000000000000000	15000000000000000000	22000000000000000000
LSMV M15000000000000000000	15000000000000000000	22000000000000000000	30000000000000000000
LSMV M22000000000000000000	22000000000000000000	30000000000000000000	40000000000000000000
LSMV M30000000000000000000	30000000000000000000	40000000000000000000	55000000000000000000
LSMV M40000000000000000000	40000000000000000000	55000000000000000000	75000000000000000000
LSMV M55000000000000000000	55000000000000000000	75000000000000000000	110000000000000000000
LSMV M75000000000000000000	75000000000000000000	110000000000000000000	150000000000000000000
LSMV M110000000000000000000	110000000000000000000	150000000000000000000	220000000000000000000
LSMV M150000000000000000000	150000000000000000000	220000000000000000000	300000000000000000000
LSMV M220000000000000000000	220000000000000000000	300000000000000000000	400000000000000000000
LSMV M300000000000000000000	300000000000000000000	40000000000000000	

LSMV: THE VARIABLE SPEED SOLUTION FOR ALL APPLICATIONS

The constructional features that guarantee security for all applications:

- **IEC shaft and fixing dimensions**
- **Higher balancing Class, level A or B** for increased lifespan of bearings as well as reduced vibrations and noise
- **Aluminium alloy frame** for superior thermal dissipation and power-to-weight ratio
- **Cast iron end-shields at both ends** for stronger housings and better fit for bearings
- **Specific control of rotor and stator tolerances** for better utilisation of air-gap flux over the whole speed range
- **Guaranteed torque and thermal performance on inverter supply**
- **Enhanced winding insulation system reducing risk of breakdown** for peak voltage > 1500 V, but < 2500 V, higher insulation system available
- **PTC thermistors as standard for thermal protection**

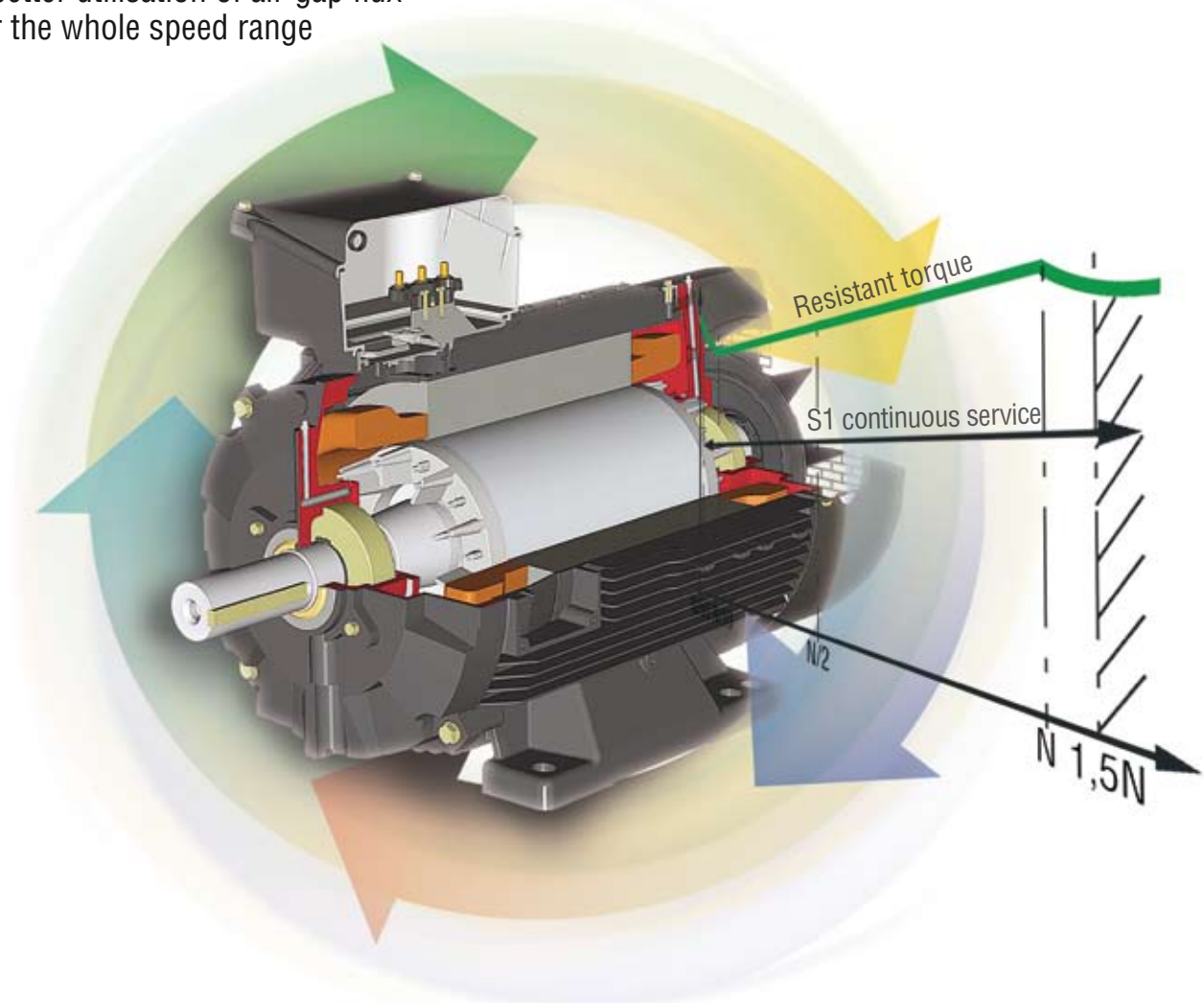

Asynchronous LSMV motors for speed variation

Summary

	PAGES		PAGES
A - TORQUE CHARACTERISTICS		E - CONSTRUCTION	
A1 – Performance based on network supply 400 V - 50 Hz via inverter	4 to 9	E1 – Definition of the protection indices (IP/IK)	46
A2 – Performance based on inverter output supply 400 V - 87 Hz	10 to 12	E2 – Integral components	47
B - OPTIONAL EQUIPMENT		E3 – Paint	48
B1 – Speed feedback	14 to 16	E4 – Construction form and operating positions	49
Choice of speed feedback		E5 – Bearings and lubrication	50
Incremental encoder		E6 – Connection	51
Absolute encoder		E7 – Machine vibration level	52-53
Bearing sensor		F - GENERAL INFORMATION	
B2 – Brake	17 to 22	F1 – Quality commitment	56
Brake choice		F2 – Standards and agreements	57 to 59
Characteristics LSMV + BK/FMC Brake		F3 – Designation	60
Characteristics LSMV + FCR Brake			
Characteristics LSMV + FCPL Brake			
B3 – Forced ventilation	23		
B4 – Reinforced insulation	24		
Reinforced insulation of the winding			
Reinforced insulation of the mechanical parts			
B5 – Cable glands	24		
B6 – Thermal protection	25		
B7 – Varmeca	26		
B8 – Connectable plug	26		
C - ELECTRICAL CHARACTERISTICS			
C1 – Selection charts	28 to 33		
D - DIMENSIONS			
D1 – Shaft ends	36		
D2 – Foot mounted IM B3 (IM 1001)	37		
D3 – Foot and Flange mounted with plain holes IM B35 (IM 2001)	38		
D4 – Flange mounted with plain holes IM B5 (IM 3001)	39		
D5 – Foot and Flange mounted with tapped holes IM B34 (IM 2101)	40		
D6 – Flange mounted with tapped holes B14 (IM 3601)	41		
D7 – Overall dimensions of options	42-43		

Asynchronous LSMV motors for speed variation

Index

	PAGES		PAGES
AFNOR/UTE.....	57	JIS	57
Shaft	47	Sealing joints	47
Terminal box	47-51	Bearing lubrication.....	50
Connecting	16-19-23-51	Mounting methods	49
Fan cover.....	47	NEMA	57
Electrical characteristics.....	27 to 33	Vibration level	52
Torque characteristics.....	3 to 12	STANDARDS	57 to 59
Finned housing	47	Options	13 to 26-42 to 43
IEC.....	57	Paint	48
Deflector	47	Inverter performances	3 to 12
Incremental encoder.....	15-16	Terminal block.....	51
Absolute encoder.....	15	Operating positions.....	49
Connectable plug.....	26	Cable gland	24-51
Construction	47	Thermal protection.....	25
Motor torques	3 to 12	Quality	56
Description.....	47	Connection	16-19-23-51
Designation.....	60	Rotor	47
LSMV Dimensions.....	36 to 41	Bearings	47-50
LSMV Dimensions and options	42 to 43	Bearing sensor	16
DIN/VDE	57	Connecting diagram	16-19-23-51
Balancing.....	52	Selection.....	3 to 12
Endshields and bearings	47	Stator	47
Construction forms	49	Painting systems	48
Brake	17 to 22	UL/CSA	59
Grease	50	Varmeca	26
Identification	60	Forced ventilation	23
Protection indices	46	Vibration	52-53
ISO 9001	56	Mechanical speeds.....	53
Reinforced insulation	24		

Asynchronous LSMV motors for speed variation Torque characteristics

PAGES

A1 - Performance based on network supply 400 V 50 Hz via inverter

2 poles	4 - 5
4 poles	6 - 7
6 poles	8 - 9

A2 - Performance based on inverter output supply 400 V 87 Hz

2 poles	10
4 poles	11
6 poles	12



Asynchronous LSMV motors for speed variation Torque characteristics

A1 - Performance based on network supply 400 V 50 Hz via inverter

2
poles

Star connected motor (Y)

Type	Rated power at 50 Hz P_n kW	Rated torque C_n N.m	Frequency Hz		5	10	15	20	25	30	35	40	45	50
			Speed* min ⁻¹											
LSMV 71 L	0,25	0,82	torque	N.m	0,8	0,8	0,8	0,8	0,8	0,8	0,8	0,8	0,8	0,8
			current	A	0,7	0,7	0,7	0,7	0,7	0,7	0,7	0,7	0,7	0,7
LSMV 71 L	0,37	1,22	torque	N.m	1,2	1,2	1,2	1,2	1,2	1,2	1,2	1,2	1,2	1,2
			current	A	1,0	1,0	1,0	1,0	1,0	1,0	1,0	1,0	1,0	1,0
LSMV 71 L	0,55	1,82	torque	N.m	1,8	1,8	1,8	1,8	1,8	1,8	1,8	1,8	1,8	1,8
			current	A	1,3	1,4	1,4	1,4	1,4	1,4	1,4	1,4	1,4	1,4
LSMV 80 L	0,75	2,5	torque	N.m	2,6	3	3	3	3	3	3	3	3	3
			current	A	1,9	2,2	2,1	2,2	2,1	2	2,1	2,1	2,1	2,1
LSMV 80 L	1,1	3,7	torque	N.m	4	4	4	4	4,3	4,5	4,5	4,5	4,3	4
			current	A	2,6	2,7	2,3	3	2,3	3,1	2,3	3	2,3	2,8
LSMV 90 L	1,5	5	torque	N.m	5,7	6	6	6	6	6	6	6	6	6
			current	A	3,7	4,2	4,4	4,4	4,4	4,3	4,4	4	4,4	4,4
LSMV 90 L	2,2	7,1	torque	N.m	7	8	8	8	8,2	8,5	8,8	9	8,8	8,3
			current	A	4,6	5	6,1	5,7	6,1	5,9	6,1	6,1	6,1	6,1
LSMV 100 L	3	9,9	torque	N.m	10	11	11,2	11,5	11,8	12	12,5	12,5	12	11,5
			current	A	6,7	7	8,2	7,5	8,2	8,3	8,2	8,4	8,2	8,2
LSMV 112 MG	4	13,2	torque	N.m	12	13,5	13,8	14	14,5	15	15,3	15,5	15	14,4
			current	A	7,5	7,5	7,5	7,5	7,5	7,5	7,5	7,5	7,5	7,5
LSMV 132 SM	5,5	18	torque	N.m	20	20	20	20	20	20	20	20	19,5	19,5
			current	A	12	11,3	13,1	12,9	13,1	13	13,1	12,6	13,1	13,1
LSMV 132 M	7,5	24,5	torque	N.m	23	26	27	28	28	28	28	28	27	26
			current	A	14,6	14,5	17,1	17	17,1	17,3	17,1	17	17,1	17
LSMV 132 M	9	29,3	torque	N.m	28	31	32	33	33	33	33	33	32	31
			current	A	16	18	18	19	19	19	19	19	19	18
LSMV 132 M	11	36	torque	N.m	35	39	40	41	42	43	43	43	42	41
			current	A	19,2	23,2	25	25,4	25,8	26	26	25,7	26	26,5
LSMV 160 MP	11	35,8	torque	N.m	36	40	41	42	43	44	44	44	43	42
			current	A	18	20	20	21	21	22	22	22	21	20,6
LSMV 160 MR	15	48,7	torque	N.m	43	50	52	55	58	60	60	60	59	57
			current	A	26,3	29	33	33,6	34	36,8	35,4	35,4	35,4	35,4

* speed given without slip

The torques given in this table are measured under the following conditions:

- class B temperature rise at all points
- control rule U/F constant

The rated torque can be maintained over a speed range from 5 to 50 Hz with F or B temperature rise depending on the drive frequency and control mode (open or closed loop vector control).

Asynchronous LSMV motors for speed variation Torque characteristics

Star connected motor (Y)

Type	Rated power at 50 Hz P_n kW	Rated torque C_n N.m	Motor with forced ventilation																							
			Frequency Hz		55		60		65		70		75		80		85		90		95		100			
			Speed*	min ⁻¹	3300	3600	3900	4200	4500	4800	5100	5400	5700	6000	torque	N.m	current	A	torque	N.m	current	A	torque	N.m	current	A
LSMV 71 L	0,25	0,82	torque	N.m	0,7	0,7	0,6	0,6	0,5	0,5	0,5	0,5	0,4	0,4	current	A	0,7	0,7	0,7	0,6	0,6	0,7	0,7	0,6	0,7	0,7
			torque	N.m	1,1	1,0	0,9	0,9	0,8	0,7	0,7	0,7	0,6	0,6	current	A	1,0	0,9	0,9	0,9	0,9	0,9	0,9	0,9	0,9	0,9
LSMV 71 L	0,55	1,82	torque	N.m	1,6	1,5	1,3	1,3	1,2	1,1	1,0	1,0	0,9	0,9	current	A	1,3	1,3	1,3	1,3	1,3	1,3	1,3	1,3	1,3	1,3
			torque	N.m	2,8	2,5	2,4	2,2	2	1,9	1,8	1,7	1,3	1,2	current	A	2,1	2,1	2,1	2,1	2,1	2,1	2,2	2,1	2,1	2,1
LSMV 80 L	1,1	3,7	torque	N.m	3,8	3,5	3,3	3	2,8	2,6	2,4	2,2	1,8	1,8	current	A	2,3	3	2,3	2,9	2,3	2,9	2,3	2,8	2,3	2,3
			torque	N.m	5,5	5	4,5	4,2	3,9	3,7	3,5	3,3	2,5	2,4	current	A	4,4	4,3	4,4	4,3	4,4	4,3	4,4	4,4	4,4	4,4
LSMV 90 L	2,2	7,1	torque	N.m	7	6,5	6	5,5	5	4,8	4,6	4,2	3,7	3,5	current	A	6,1	5,9	6,1	5,7	6,1	5,8	6,1	6,1	6,1	6,1
			torque	N.m	11	9	8	7,1	6,8	6,2	6	5,4	5,0	4,8	current	A	8,2	7,6	8,2	6,5	8,2	6,9	8,2	7,2	8	8
LSMV 100 L	4	13,2	torque	N.m	13	11,5	10,5	9,2	8,8	8	7,5	7	6,7	6,4	current	A	7,5	7,5	7,5	7,5	7,5	7,5	7,5	7,5	7,5	7,5
			torque	N.m	17,5	16,5	15	14	13	11,5	10,5	9,5	9,2	8,8	current	A	13,1	12,7	13,1	12,8	13,1	12,7	13,1	12,7	13,1	13,1
LSMV 132 SM	7,5	24,5	torque	N.m	24	22	20	18	16,5	15,5	14	13	12,6	11,9	current	A	17,1	17,8	17,1	16,7	17,1	17,4	17,1	16,1	17,1	17,1
			torque	N.m	29	26	24	22	20	19	17	16	15	14	current	A	16	15	13	12	11	10	9	9	9	8
LSMV 132 M	9	29,3	torque	N.m	38	33	30	26	24	22	20	18	18,4	17,5	current	A	25	24,6	23,2	23,4	23	22,6	23	23,7	23	23,7
			torque	N.m	39	33	30	26	24	22	20	18	19	18	current	A	19	17	15	13	12	11	10	9	10	9
LSMV 160 MP	11	35,8	torque	N.m	50	43	37	35	32	30	28	27	25	24	current	A	35,4	30,8	30	30	30	30,2	30,3	30,5	30,5	30,5
			torque	N.m	50	43	37	35	32	30	28	27	25	24	current	A	35,4	30,8	30	30	30	30,2	30,3	30,5	30,5	30,5

* speed given without slip

Asynchronous LSMV motors for speed variation Torque characteristics

A1 - Performance based on network supply 400 V 50 Hz via inverter

4
poles

Star connected motor (Y)

Type	Rated power at 50 Hz P_n kW	Rated torque C_n N.m	Frequency Hz		5	10	15	20	25	30	35	40	45	50
			Speed* min ⁻¹		150	300	450	600	750	900	1050	1200	1350	1500
LSMV 71 L	0,18	1,19	torque	N.m	1,2	1,2	1,2	1,2	1,2	1,2	1,2	1,2	1,2	1,2
			current	A	0,6	0,6	0,6	0,6	0,6	0,6	0,7	0,7	0,7	0,7
LSMV 71 L	0,25	1,68	torque	N.m	1,6	1,6	1,6	1,6	1,6	1,6	1,6	1,6	1,6	1,6
			current	A	0,8	0,9	0,9	0,9	0,9	0,9	0,9	0,9	0,9	0,9
LSMV 71 L	0,37	2,44	torque	N.m	2,5	2,5	2,5	2,5	2,5	2,5	2,5	2,4	2,5	2,5
			current	A	1,2	1,2	1,2	1,2	1,2	1,2	1,2	1,2	1,2	1,2
LSMV 80 L	0,55	3,7	torque	N.m	4,1	4,1	4,1	4,1	4,1	4,1	4,1	4,1	4,1	4,1
			current	A	1,7	1,7	1,7	1,7	1,7	1,7	1,7	1,7	1,7	1,7
LSMV 80 L	0,75	4,9	torque	N.m	4,5	5,0	5,3	5,5	5,5	5,5	5,5	5,5	5,5	5,5
			current	A	1,9	2,1	2,2	2,2	2,2	2,2	2,2	2,2	2,2	2,3
LSMV 90 SL	1,1	7,2	torque	N.m	7,0	7,5	8,0	8,2	8,3	8,4	8,5	8,5	8,5	8,5
			current	A	2,4	2,5	2,6	2,8	2,9	3,0	2,9	2,8	2,9	2,9
LSMV 90 L	1,5	9,9	torque	N.m	8,5	9,5	9,5	9,5	9,6	9,7	9,82	10	10,5	11
			current	A	3,2	3,2	3,3	3,5	3,6	3,7	3,8	3,8	3,9	3,9
LSMV 100 L	2,2	14,6	torque	N.m	12	14	14	14	14,3	14,6	15	15,3	15,8	16
			current	A	3,5	4,7	4,7	5	5	5	5	5	5,2	5,2
LSMV 100 L	3	19,4	torque	N.m	15	17	18	19	19,6	20,5	21	21	21	21
			current	A	5,3	5,9	6,2	6,8	7	7	7,3	7,6	7,7	7,8
LSMV 112 MG	4	26	torque	N.m	22	25	25,5	26	26,6	27,2	28	28	28	28
			current	A	7,1	8,3	8,4	8,8	9	9,5	9,3	9,1	9,3	9,5
LSMV 132 SM	5,5	37	torque	N.m	38	38	39	40	40	40	40	40	39,5	39
			current	A	11,2	11,5	12	13	13	13	13	12,6	12,7	12,9
LSMV 132 M	7,5	49,4	torque	N.m	40	48	49	50	50	50	50	50	50	50
			current	A	12,7	14,5	15,5	16,1	15,8	15,7	15,8	16,1	15,8	15,7
LSMV 132 M	9	58,8	torque	N.m	50	58	60,5	63	64	65	66	66	65	65
			current	A	13,1	14,4	16,8	16,4	16,8	17,4	16,8	17,9	16,8	17,3
LSMV 160 MR	11	71,7	torque	N.m	65	73	75	78	78,6	79,4	80	79,5	79	78
			current	A	20,2	20,2	20,2	20,2	20,2	20,2	20,2	20,2	20,2	20,2
LSMV 160 LU	15	98	torque	N.m	77	89	101	107	112	114	115	116	115	112
			current	A	23	26	31	33	35	35	35	35	35	35
LSMV 180 M	18,5	120	torque	N.m	110	113	120	127	133	138	143	143	145	138
			current	A	35	36	37	39	41	41	41	42	42	43
LSMV 180 LU	22	143	torque	N.m	121	136	147	155	161	165	168	171	169	164
			current	A	37	39	45	47	49	49	50	50	50	50
LSMV 200 L	30	194	torque	N.m	160	177	191	201	209	217	222	223	219	212
			current	A	55	57	59	63	65	66	66	66	66	66
LSMV 225 SR	37	240	torque	N.m	166	198	226	238	247	254	257	258	256	251
			current	A	44	55	66	68	72	73	74	75	75	75
LSMV 225 MG	45	290	torque	N.m	260	291	313	328	340	348	355	353	351	346
			current	A	82	85	87	93	98	99	100	100	100	100
LSMV 250 ME	55	354	torque	N.m	275	330	375	388	398	408	415	411	406	395
			current	A	86	92	106	110	113	113	113	113	113	112
LSMV 280 SD	75	483	torque	N.m	348	433	475	494	508	518	521	519	512	500
			current	A	125	130	136	140	145	145	145	145	145	145
LSMV 280 MK	90	577	torque	N.m	440	510	570	605	635	660	675	670	660	640
			current	A	145	155	167	180	189	190	190	190	190	190
LSMV 315 SP	110	706	torque	N.m	562	635	708	724	740	752	761	758	753	743
			current	A	188	190	211	218	223	224	224	224	224	224
LSMV 315 MR	132	847	torque	N.m	735	850	920	960	970	980	990	1010	1030	1010
			current	A	176	199	212	219	221	223	225	230	235	230

* speed given without slip

The torques given in the table are measured under the following conditions:

- class B temperature rise at all points
- control rule U/F constant

The rated torque can be maintained over a speed range from 5 to 50 Hz with F or B temperature rise depending on the drive frequency and control mode (open or closed loop vector control).

Asynchronous LSMV motors for speed variation Torque characteristics

Star connected motor (Y)

Type	Rated power at 50 Hz P_n kW	Rated torque C_n N.m	Frequency Hz		55	60	65	70	75	80	85	90	95	100
			speed*	min ⁻¹	1650	1800	1950	2100	2250	2400	2550	2700	2850	3000
			torque	N.m										
LSMV 71 L	0,18	1,19	torque	N.m	1,0	1,0	0,9	0,8	0,8	0,7	0,7	0,6	0,6	0,6
			current	A	0,6	0,6	0,6	0,5	0,5	0,5	0,5	0,5	0,5	0,5
LSMV 71 L	0,25	1,68	torque	N.m	1,4	1,3	1,2	1,1	1,1	1,0	0,9	0,9	0,8	0,8
			current	A	0,8	0,8	0,7	0,7	0,7	0,7	0,7	0,7	0,7	0,7
LSMV 71 L	0,37	2,44	torque	N.m	2,1	2,0	1,8	1,7	1,6	1,5	1,4	1,3	1,2	1,2
			current	A	1,2	1,1	1,0	1,0	1,0	1,0	1,0	1,0	1,0	1,0
LSMV 80 L	0,55	3,7	torque	N.m	3,2	2,9	2,7	2,5	2,3	2,2	2,1	1,9	1,8	1,8
			current	A	1,7	1,7	1,7	1,7	1,7	1,7	1,7	1,7	1,7	1,7
LSMV 80 L	0,75	4,9	torque	N.m	5,0	4,6	4,3	4,0	3,8	3,5	3,3	3,1	2,8	2,5
			current	A	2,2	2,1	2,1	2,2	2,2	2,2	2,2	2,2	2,2	2,2
LSMV 90 SL	1,1	7,2	torque	N.m	7,7	7,2	6,6	6,1	5,6	5,0	4,6	4,3	3,9	3,5
			current	A	2,9	3,0	3,0	3,0	2,9	2,8	2,8	2,9	2,9	2,9
LSMV 90 L	1,5	9,9	torque	N.m	10	9	8	7	6,5	6	5,7	5,33	5	4,7
			current	A	4	4	3,9	3,8	3,8	3,8	4	4,1	4,1	4,1
LSMV 100 L	2,2	14,6	torque	N.m	15	13,8	12	11	10,43	9,7	9	8	7,5	7
			current	A	5	5	5	5,4	5,6	5,9	5,8	5,6	5,5	5,5
LSMV 100 L	3	19,4	torque	N.m	19,5	18	16,5	15	14	13	12	11	10	9
			current	A	7,7	7,6	7,6	7,6	7,6	7,6	7,5	7,4	7,4	7,5
LSMV 112 MG	4	26	torque	N.m	25	22	20,5	19	17,5	16,5	15,5	14,5	14	13
			current	A	9,4	9,3	9,4	9,6	9,6	9,6	9,6	9,6	9,6	9,5
LSMV 132 SM	5,5	37	torque	N.m	34,5	32	29,5	27	25	23	21,5	20	18	17,4
			current	A	13	13	12,8	12,7	12,5	12	12,8	13,2	13,1	13,1
LSMV 132 M	7,5	49,4	torque	N.m	45,5	41	37,5	34	31,5	29	27	25	23,5	22
			current	A	15,8	15,8	15,7	15,7	16	16,2	16,1	16,1	16	15,9
LSMV 132 M	9	58,8	torque	N.m	59,5	54	49,5	45	42	39	36	33	31	29
			current	A	16,8	17,3	16,8	17,3	16,8	17,3	16,8	17,3	16,8	17,3
LSMV 160 MR	11	71,7	torque	N.m	72	66	60,5	55	50	45	43	41	38,5	36
			current	A	20,2	20,2	20,2	20,2	20,2	20,2	20,2	20,2	20,2	20,2
LSMV 160 LU	15	98	torque	N.m	103	93	85	77	71	64	56	53	50	48
			current	A	35	35	35	35	35	35	35	35	35	35
LSMV 180 M	18,5	120	torque	N.m	126	113	105	96	87	78	69	65	62	56
			current	A	43	42	41	41	40	40	40	40	40	40
LSMV 180 LU	22	143	torque	N.m	147	129	119	108	100	91	81	77	70	63
			current	A	50	50	50	50	50	49	49	48	48	48
LSMV 200 L	30	194	torque	N.m	197	182	160	144	130	121	112	101	101	87
			current	A	66	66	66	66	66	66	66	66	66	66
LSMV 225 SR	37	240	torque	N.m	232	216	200	180	164	150	139	126	124	108
			current	A	75	75	75	75	74	74	74	74	74	74
LSMV 225 MG	45	290	torque	N.m	320	294	268	248	223	203	169	170	151	145
			current	A	100	100	100	100	100	100	100	100	100	100
LSMV 250 ME	55	354	torque	N.m	379	355	320	292	265	238	206	195	184	170
			current	A	112	112	112	112	112	111	111	111	111	111
LSMV 280 SD	75	483	torque	N.m	450	392	360	340	320	300	281	252	251	216
			current	A	144	144	144	144	144	143	143	143	143	143
LSMV 280 MK	90	577	torque	N.m	590	530	484	447	400	375	337	318	302	272
			current	A	190	190	190	190	190	190	190	190	190	190
LSMV 315 SP	110	706	torque	N.m	700	640	588	547	500	458	412	389		
			current	A	224	224	224	224	224	232	232	232		
LSMV 315 MR	132	847	torque	N.m	900	820	760	700	640	510	536	490		
			current	A	205	187	173	159	146	116	123	115		

* speed given without slip

Asynchronous LSMV motors for speed variation Torque characteristics

A1 - Performance based on network supply 400 V 50 Hz via inverter

6
poles

Star connected motor (Y)

Type	Rated power at 50 Hz P_n kW	Rated torque C_n N.m	Frequency Hz		5	10	15	20	25	30	35	40	45	50	
			Speed* min ⁻¹		100	200	300	400	500	600	700	800	900	1000	
LSMV 90 S	0,75	7,8	torque	N.m	7	7,2	7,5	7,7	7,9	8	8	8	8	8	
			current	A	1,8	1,9	2,0	2,0	2,1	2,1	2,1	2,1	2,1	2,1	
			torque	N.m	8,5	9	9,5	9,7	9,9	10	10	10	10	10	10
LSMV 90 L	1,1	11,4	current	A	2,6	2,7	2,9	2,9	3	3	3	3	3	3	
			torque	N.m	12	12,5	13	13,4	13,7	14	14	14	14	14	
			current	A	3,6	3,8	3,9	4	4,1	4,2	4,2	4,2	4,2	4,2	
LSMV 100 L	1,5	14,3	torque	N.m	16,0	16,8	17,6	18,4	19,4	20,0	20,2	20,5	20,7	21,0	
			current	A	4,4	4,7	4,9	5,1	5,4	5,5	5,6	5,7	5,7	5,8	
			torque	N.m	22	23,43	25	26	27	28	28	28	28	28	28
LSMV 112 M	2,2	22,6	current	A	5,6	5,9	6,3	6,6	6,8	7,1	7,1	7,1	7,1	7,1	
			torque	N.m	35	35,5	36	36	36	36	36	35,9	35,36	35	
			current	A	9,3	9,4	9,6	9,6	9,6	9,6	9,6	9,6	9,5	9,4	9,3
LSMV 132 S	3	30,6	torque	N.m	40	44	48	48	48	48	48	48	48	48	48
			current	A	11	13	14	14	14	14	14	14	14	14	14
			torque	N.m	59	67	74	74	74	74	74	74	74	74	74
LSMV 132 M	4	40,8	current	A	13	15	16	16	16	16	16	16	16	16	
			torque	N.m	87	98	109	109	109	109	109	109	109	109	
			current	A	19	21	23	23	23	23	23	23	23	23	
LSMV 160 M	7,5	74	torque	N.m	118	132	147	147	147	147	147	147	147	147	
			current	A	26	29	32	32	32	32	32	32	32	32	
			torque	N.m	146	164	182	182	182	182	182	182	182	182	
LSMV 160 L	11	109	current	A	30	33	37	37	37	37	37	37	37	37	
			torque	N.m	171	193	214	214	214	214	214	214	214	214	
			current	A	36	40	44	44	44	44	44	44	44	44	
LSMV 180 L	15	147	torque	N.m	234	263	292	292	292	292	292	292	292	292	
			current	A	48	54	60	60	60	60	60	60	60	60	
			torque	N.m	289	325	361	361	361	361	361	361	361	361	
LSMV 200 LT	18,5	182	current	A	57	64	71	71	71	71	71	71	71	71	
			torque	N.m	351	395	439	439	439	439	439	439	439	439	
			current	A	69	77	86	86	86	86	86	86	86	86	
LSMV 200 LU	22	214	torque	N.m	430	484	538	538	538	538	538	538	538	538	
			current	A	83	94	104	104	104	104	104	104	104	104	
			torque	N.m	585	658	731	731	731	731	731	731	731	731	
LSMV 225 MG	30	292	current	A	112	126	140	140	140	140	140	140	140	140	
			torque	N.m	702	789	877	877	877	877	877	877	877	877	
			current	A	132	149	165	165	165	165	165	165	165	165	
LSMV 250 ME	37	361	torque	N.m	877	877	877	877	877	877	877	877	877	877	
			current	A	132	149	165	165	165	165	165	165	165	165	
			torque	N.m	430	484	538	538	538	538	538	538	538	538	
LSMV 280 SC	45	439	current	A	83	94	104	104	104	104	104	104	104	104	
			torque	N.m	585	658	731	731	731	731	731	731	731	731	
			current	A	112	126	140	140	140	140	140	140	140	140	
LSMV 280 MC	55	538	torque	N.m	702	789	877	877	877	877	877	877	877	877	
			current	A	132	149	165	165	165	165	165	165	165	165	
			torque	N.m	585	658	731	731	731	731	731	731	731	731	
LSMV 315 SP	75	731	current	A	112	126	140	140	140	140	140	140	140	140	
			torque	N.m	702	789	877	877	877	877	877	877	877	877	
			current	A	132	149	165	165	165	165	165	165	165	165	
LSMV 315 MP	90	877	torque	N.m	702	789	877	877	877	877	877	877	877	877	
			current	A	132	149	165	165	165	165	165	165	165	165	
			torque	N.m	702	789	877	877	877	877	877	877	877	877	

* speed given without slip

The torques given in the table are measured under the following conditions:

- class B temperature rise at all points
- control rule U/F constant

The rated torque can be maintained over a speed range from 5 to 50 Hz with F or B temperature rise depending on the drive frequency and control mode (open or closed loop vector control).

Asynchronous LSMV motors for speed variation Torque characteristics

Star connected motor (Y)

Type	Rated power at 50 Hz P_n kW	Rated torque C_n N.m	Frequency Hz		55	60	65	70	75	80	85	90	95	100
			speed* min ⁻¹											
LSMV 90 S	0,75	7,8	torque	N.m	7	6,2	5,82	5,54	5,3	5	4,64	4,3	3,8	3,6
			current	A	1,8	1,6	1,5	1,5	1,4	1,3	1,2	1,1	1,0	0,9
LSMV 90 L	1,1	11,4	torque	N.m	9	8	7,46	6,96	6,5	6,09	5,56	5	4,5	3,3
			current	A	2,7	2,4	2,2	2,1	2,0	1,8	1,7	1,5	1,4	1,0
LSMV 100 L	1,5	15,8	torque	N.m	13	12	11	10	9	8	7,5	7	6,5	6,2
			current	A	3,9	3,6	3,3	3	2,7	2,4	2,3	2,1	2,0	1,9
LSMV 112 M	2,2	22,6	torque	N.m	19,3	17,5	16,2	15,2	14,0	12,5	11,5	10,6	9,1	8,5
			current	A	5,3	4,8	4,5	4,2	3,9	3,5	3,2	2,9	2,5	2,3
LSMV 132 S	3	30,6	torque	N.m	26	24	22	20	17	15	14	13	12,1	11,3
			current	A	6,6	6,1	5,6	5,1	4,3	3,8	3,6	3,3	3,1	2,9
LSMV 132 M	4	40,8	torque	N.m	31,1	28	26	24	22	20	18,2	17	16,1	15,1
			current	A	8,3	7,4	6,9	6,4	5,8	5,3	4,8	4,5	4,3	4,0
LSMV 132 M	5,5	56,3	torque	N.m	44	40	37	35	33	30	28	25	24	22
			current	A	13	11	11	10	9	9	8	7	7	6
LSMV 160 M	7,5	74	torque	N.m	67	61	56	52	48	44	41	37	33	30
			current	A	15	13	12	11	11	10	9	8	7	6
LSMV 160 L	11	109	torque	N.m	98	90	82	76	71	65	60	55	49	44
			current	A	21	19	17	16	15	14	13	12	10	9
LSMV 180 L	15	147	torque	N.m	132	122	110	103	96	88	81	74	66	59
			current	A	29	27	24	22	21	19	18	16	14	13
LSMV 200 LT	18,5	182	torque	N.m	164	151	137	127	118	109	100	91	82	73
			current	A	33	31	28	26	24	22	20	19	17	15
LSMV 200 LU	22	214	torque	N.m	193	178	161	150	139	128	118	107	96	86
			current	A	40	37	33	31	29	27	24	22	20	18
LSMV 225 MG	30	292	torque	N.m	263	242	219	204	190	175	161	146	131	117
			current	A	54	50	45	42	39	36	33	30	27	24
LSMV 250 ME	37	361	torque	N.m	325	300	271	253	235	217	199	181	162	144
			current	A	64	59	53	50	46	43	39	36	32	28
LSMV 280 SC	45	439	torque	N.m	395	364	329	307	285	263	241	220	198	176
			current	A	77	71	65	60	56	52	47	43	39	34
LSMV 280 MC	55	538	torque	N.m	484	447	404	377	350	323	296	269	242	215
			current	A	94	86	78	73	68	62	57	52	47	42
LSMV 315 SP	75	731	torque	N.m	658	607	548	512	475	439	402	366	329	292
			current	A	126	116	105	98	91	84	77	70	63	56
LSMV 315 MP	90	877	torque	N.m	789	728	658	614	570	526	482	439	395	351
			current	A	149	137	124	116	107	99	91	83	74	66

* speed given without slip

Asynchronous LSMV motors for speed variation Torque characteristics

A2 - Performance based on inverter output supply 400 V 87 Hz

2
poles

A

SUPPLY 400 V 50 Hz		
Star connected motor (Y)		
Type	Rated power	Rated network torque
	P_n kW	$C_{rated\ network}$ N.m
LSMV 71 L	0,25	0,82
LSMV 71 L	0,37	1,22
LSMV 71 L	0,55	1,82
LSMV 80 L	0,75	2,5
LSMV 80 L	1,1	3,7
LSMV 90 L	1,5	5
LSMV 90 L	2,2	7,1
LSMV 100 L	3	9,9
LSMV 112 MG	4	13,2
LSMV 132 SM	5,5	18
LSMV 132 M	7,5	24,5
LSMV 132 M	9	29,3
LSMV 132 M	11	36
LSMV 160 MP	11	35,8
LSMV 160 MR	15	48,7

SUPPLY 400 V 87 Hz					
Delta connected motor (Δ)					
Power	Torque	Current	Speed	Power factor	Output
P kW	C N.m	I A	N min ⁻¹	$\cos \varphi$	η %
0,4	0,82	0,9	5220	0,67	72,3
0,6	1,22	1,3	5220	0,68	73,4
1,0	1,82	1,9	5220	0,73	76,6
1,3	2,5	2,8	4985	0,88	80
1,9	3,7	4,1	5011	0,87	83
2,6	5	5,3	5020	0,9	83
3,8	7,1	8,5	5029	0,85	83
5	9,9	10,6	5003	0,89	84
7	13,2	14	5046	0,92	84
10	18	18	5072	0,91	86
13	24,5	25	5063	0,92	86
16	29,3	31	5220	0,88	88,5
19	36	38	5220	0,85	90
19	35,8	38	5220	0,87	89
26	48,7	52	5220	0,86	90

For any applications not listed above, the motors can be directly connected in delta 230 V 50 Hz and taken to 400 V 87 Hz.

But, for the following cases, a star connection is recommended:

- * regenerative operations: presses, cranes...
- * short cycle operations with short acceleration and deceleration times (> 60 cycles/h)
- * highly unbalanced applications.
- * relative humidity > 90 %.

Asynchronous LSMV motors for speed variation Torque characteristics

A2 - Performance based on inverter output supply 400 V 87 Hz

4
poles

SUPPLY 400 V 50 Hz
Star connected motor (Y)

Type	Rated power	Rated network torque
	P_n kW	$C_{rated\ network}$ N.m
LSMV 71 L	0,18	1,19
LSMV 71 L	0,25	1,88
LSMV 71 L	0,37	2,44
LSMV 80 L	0,55	3,7
LSMV 80 L	0,75	4,9
LSMV 90 SL	1,1	7,2
LSMV 90 L	1,5	9,9
LSMV 100 L	2,2	14,6
LSMV 100 L	3	19,4
LSMV 112 MG	4	26
LSMV 132 SM	5,5	37
LSMV 132 M	7,5	49,4
LSMV 132 M	9	58,8
LSMV 160 MR	11	71,7
LSMV 160 LU	15	97,8
LSMV 180 M	18,5	120
LSMV 180 LU	22	143
LSMV 200 L	30	194
LSMV 225 SR	37	240
LSMV 225 MG	45	290
LSMV 250 ME	55	354
LSMV 280 SD	75	483
LSMV 280 MK	90	577
LSMV 315 SP	110	706
LSMV 315 MR	132	846

SUPPLY 400 V 87 Hz
Delta connected motor (Δ)

Power	Torque	Current	Speed	Power factor	Output
P kW	C N.m	I A	N min^{-1}	$\cos \varphi$	η %
0,3	1,19	0,6	2610	0,57	69
0,4	1,88	0,9	2610	0,58	70
0,6	2,44	1,3	2610	0,58	71
1,0	3,7	1,9	2610	0,71	68
1,3	4,9	3,7	2497	0,71	77
1,9	7,2	4,5	2514	0,82	79
2,6	9,9	5,9	2497	0,84	80
3,8	14,6	8,5	2506	0,83	81
5	19,4	11,5	2497	0,82	81
7	26	15	2506	0,81	85
10	37	19	2540	0,87	86
13	49,4	25	2532	0,89	87
16	58,8	31	2540	0,88	88
19	71,7	37	2540	0,88	89
26	97,8	52	2551	0,85	90,7
32	120	63	2545	0,84	92,4
38	143	74	2555	0,84	92,8
52	194	102	2565	0,83	93
64	240	124	2563	0,84	93,3
78	290	151	2572	0,83	94,3
91,5	340	180	2572	0,84	94,2
116	430	220	2572	0,83	94,9
144	531	278	2595	0,85	95,2
171	629	335	2595	0,84	95,4
207	761	391	2595	0,83	95

For any applications not listed above, the motors can be directly connected in delta 230 V 50 Hz and taken to 400 V 87 Hz.

But, for the following cases, a star connection is recommended:

- * regenerative operations: presses, crane...
- * short cycle operations with short acceleration and deceleration times (> 60 cycles/h)
- * highly unbalanced applications.
- * relative humidity > 90 %.

Asynchronous LSMV motors for speed variation Torque characteristics

A2 - Performance based on inverter output supply 400 V 87 Hz

6
poles

A

SUPPLY 400 V 50 Hz		
Star connected motor (Y)		
Type	Rated power P_n kW	Rated network torque $C_{NDM RESEAU}$ N.m
LSMV 90 S	0,75	7,8
LSMV 90 L	1,1	11,4
LSMV 100 L	1,5	15,8
LSMV 112 M	2,2	22,6
LSMV 132 S	3	30,6
LSMV 132 M	4	40,8
LSMV 132 M	5,5	56,3
LSMV 160 M	7,5	74
LSMV 160 L	11	109
LSMV 180 L	15	147
LSMV 200 LT	18,5	182
LSMV 200 LU	22	214
LSMV 225 MG	30	292
LSMV 250 ME	37	361
LSMV 280 SC	45	439
LSMV 280 MC	55	538
LSMV 315 SP	75	731
LSMV 315 MP	90	877

SUPPLY 400 V 87 Hz					
Delta connected motor (Δ)					
Power	Torque	Current	Speed	Power factor	Output
P kW	C N.m	I A	N min ⁻¹	$\cos \varphi$	η %
1,3	7,8	3,8	1618	0,77	68
1,9	11,4	5,5	1592	0,75	70
2,6	15,8	7,7	1575	0,74	70
3,8	22,6	10,6	1575	0,76	72
5,2	30,6	13,0	1644	0,78	81
6,9	40,8	17,1	1679	0,75	84
9,5	56,3	23,5	1688	0,71	84
13	74	29,3	1700	0,77	86,5
19	109	42	1700	0,77	86,9
26	147	55	1705	0,81	88,7
32	182	68	1703	0,81	89
38	214	80	1715	0,77	91,4
52	292	108	1717	0,80	92,3
63	350	132	1715	0,81	92,7
75	417	155	1713	0,81	92,2
88	490	188	1711	0,82	92,8
118	660	257	1715	0,83	93,3
142	790	301	1715	0,84	93,4

For any applications not listed above, the motors can be directly connected in delta 230 V 50 Hz and taken to 400 V 87 Hz.

But, for the following cases, a star connection is recommended:

- * regenerative operations: presses, cranes...
- * short cycle operations with short acceleration and deceleration times (> 60 cycles/h)
- * highly unbalanced applications.
- * relative humidity > 90 %.

Asynchronous LSMV motors for speed variation Optional equipment

PAGES

B1 - Speed feedback

Speed feedback selection.....	14
Incremental encoder	15-16
Absolute encoder	15-16
Bearing sensor	16

B2 - Brake

Brake selection	17
Characteristics LSMV + BK/FMC Brake	18 to 20
Characteristics LSMV + FCR Brake.....	21
Characteristics LSMV + FCPL Brake.....	22

B3 - Forced ventilation

23

B4 - Reinforced insulation

Reinforced insulation for the winding.....	24
Reinforced insulation for the mechanical parts.....	24

B5 - Cable gland

24

B6 - Thermal protection

25

B7 - Varmeca

26

B8 - Connectable plug

26



Asynchronous LSMV motors for speed variation Optional equipment

B1 - Speed feedback option

B1.1 - SPEED FEEDBACK SELECTION

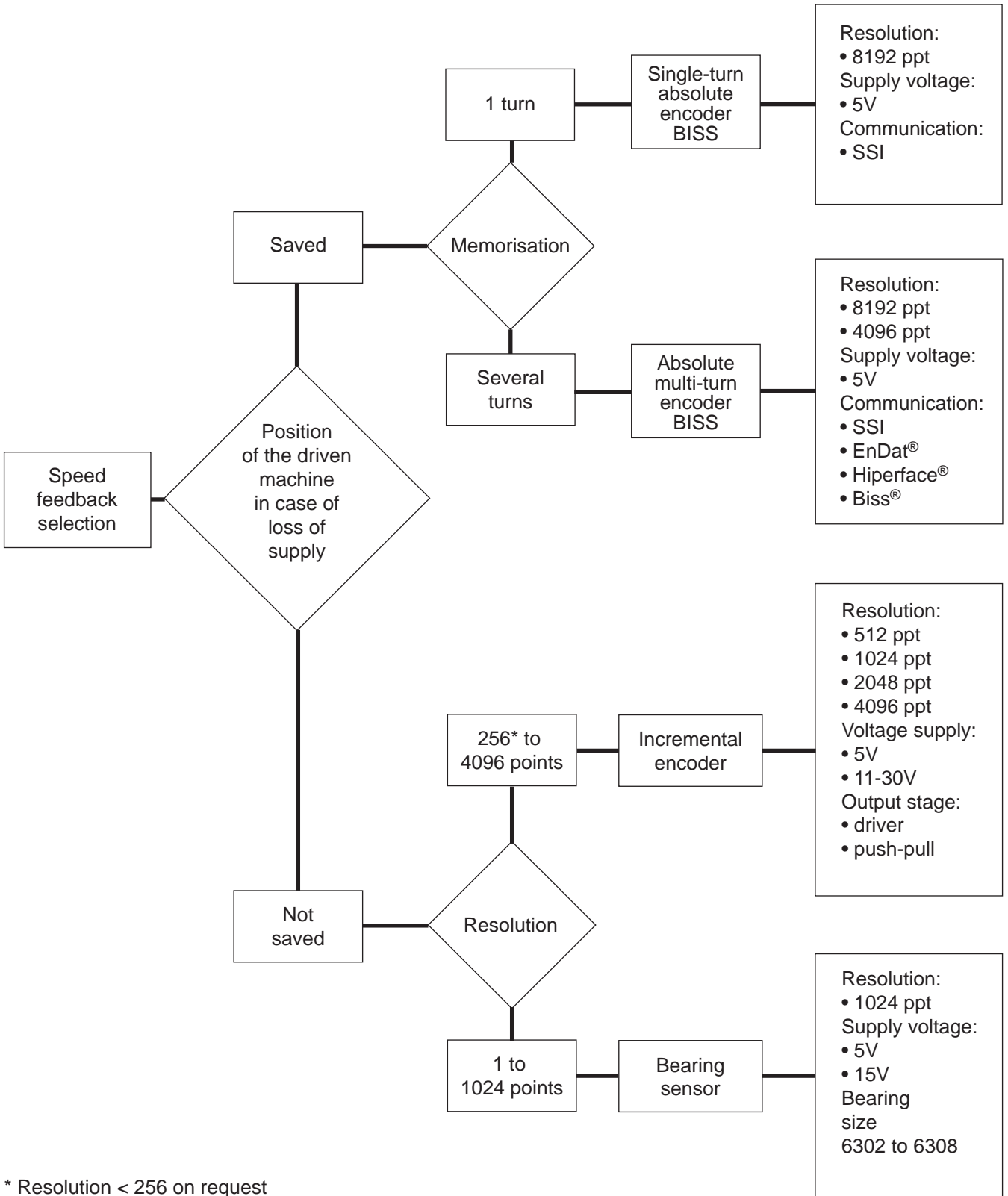

* Resolution < 256 on request

Asynchronous LSMV motor for speed variation Optional equipment

B1 - Speed feedback option

B1.2 - ENCODER OPTION

B1.2.1 - Incremental encoder

This pulse generator delivers a number of pulses proportional to the speed of the motor. It has a hollow connecting shaft, with a 2 track output + Top 0 + supplements. It can be supplied with a 5 V +/- 10% voltage or a regulated 11-30V.

For connections greater than 20 m, the cables should have twisted pairs. The maximum length of the cables (screened) shall not exceed 150 m on the optocoupler input.

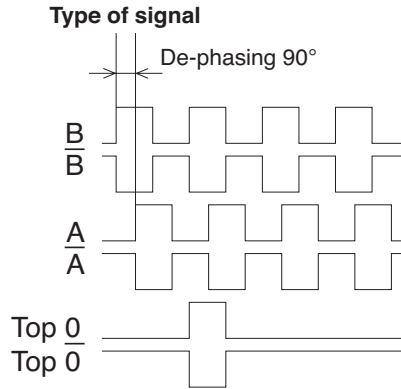

B1.2.2 - Absolute mono-turn encoder

The absolute mono-turn encoder converts a drive shaft rotation into a succession of "electrical coded steps". The number of steps per rotation, is determined by an optical disc. One shaft rotation generally has 8192 steps, which corresponds to 13 bytes. At the end of a complete encoder shaft rotation, the same values are repeated.

B1.2.3 - Absolute multi-turn encoder

The absolute multi-turn encoder saves the position on one rotation as well as for several rotations, with a maximum of 4096 turns.



B1.2.5 - Connection of an Incre-

B1.2.4 – Encoder characteristics

	INCREMENTAL ENCODER				ABSOLUTE ENCODERS				
	JHT5 S14	JHT5 S14	ERN 420	ERN 430	ECN 413 mono-turn	SRS 64 mono-turn	PHO 514 multi-turn	EQN 425 multi-turn	SRM 64 multi-turn
Supply voltage	5Vcc +/- 10 %	11-30 Vcc	5Vcc +/- 10 %	10-30 Vcc	10 to 30 Vcc 3.6V to 5 Vcc	7...12 Vcc	5 to 30 Vcc	10 to 30 Vcc 3.6V to 5 Vcc	7...12 Vcc
Standard positions per turn on request 1 to 4096 ppt	1024	1024	1024	1024	4096 max : 8192	4096	4096 max : 8192	4096 max : 8192	4096 max : 8192
Output stage	TTL 5V RS 422	11-30 HTL Push-pull	TTL 5V RS 422	11-30 HTL Push-pull	1V ~	1V ~	1V ~	1V ~	1V ~
Max. voltage (without load)	100 mA	75 mA	150 mA	150 mA	160 mA	80 mA	100 mA	200 mA	80 mA
Max. mech. continuous speed	6000 min ⁻¹	6000 min ⁻¹	10000 min ⁻¹	10000 min ⁻¹	12000 min ⁻¹	6000 min ⁻¹	6000 min ⁻¹	10000 min ⁻¹	6000 min ⁻¹
Max. scavenging frequency.	120 kHz	120 kHz	300 kHz	300 kHz	100 kHz	200 kHz	100 kHz	100 kHz	200 kHz
Shaft diameter	14 mm ACT*	14 mm ACT*	14 mm ACT*	14 mm ACT*	14 mm ACT*	14 mm ACT*	14 mm ACT*	14 mm ACT*	14 mm ACT*
Protection	IP65	IP65	IP65	IP65	IP64	IP65	IP65	IP64	IP65
Operating temperature	-20° +80 °C	-20° +80 °C	-20° +100 °C	-20° +100 °C	-40° +100 °C	-20° +110 °C	-20° +85 °C	-20° +85 °C	-20° +110 °C
Storing temperature	-30° +85 °C	-30° +85 °C	-20° +80 °C	-20° +80 °C	-40° +105 °C	-20° +115 °C	-30° +85 °C	-20° +80 °C	-20° +115 °C
Data interface					SSI EnDat®	Hiperface®	SSI	SSI EnDat®	Hiperface®
Max. cable length	150 m	150 m	100 m	300 m	100 m	100 m	150 m	100 m	100 m

*ACT : Hollow connecting shaft

Asynchronous LSMV motors for speed variation Optional equipment

B1 - Speed feedback option

Incremental encoder

ENCODER												
12 PIN	1	2	3	4	5	6	7	8	9	10	11	12
CONNECTOR	-	+	A	B	O	\bar{A}	\bar{B}	\bar{O}		\perp	\perp	\perp
SCREENED CABLE	White	Brown	Green	Yellow	Grey	Pink	Blue	Red		Braided	Braided	Braided

Encoder connection

Using incremental encoders, in industrial environments comprising high current installations or submissions from electronic inverters, requires classic fundamental and well known rules to be observed.

Basic rules:

1 - Use screened cables, For connections exceeding 20 metres, use cables with several screened twisted pairs, reinforced with a general external screening. Conductors of the same part should be reserved to a track and a complementary track: example A and \bar{A} , B and \bar{B} etc.

It is recommended to have standardised 0,14 mm² minimum section conductors (cable type recommended: LIYCY 0,14 mm²).

2 - Maintain a maximum distance between the encoder connection cables and the power cables and avoid a parallel course.

B1.3 - Bearing sensor option:

In order to make motorization as compact as possible, while proposing a precise speed measurement, the bearing sensor solution constitutes an interesting alternative.

Mounted in place of the rear bearing, conserving all of its performance, the bearing sensor integrates a system capable of delivering up to 1024 pulses per rotation on 2 tracks as well as an additional signal "Top Turn"

3 - Distribute and connect the 0V and the screening in "star".

4 - Earth the screening with cables of 4 mm² section minimum.

5 - Never connect screening to earth, at its two extremities. In preference, earth a screened cable on the "use" side of the encoder signal (cubicle, automation, counter). For the armature, the screening must be joined at one point, itself connected to the general earth conforming to security standards. As for the encoder, each screening must be perfectly insulated, in relation to any other screening, to earth or any kind of potential.

Check the continuity of the screening while using the connectors or connection boxes.

The actual range covers motor sizes from LSMV 80 up to LSMV 160LR and exists for 5 V with TTL output signals or 15 V for HTL signals.

The number of pulses varies according to the types but the most used are the 16, 32, 64 and 128 points per turn even if the resolutions up to 1024 points are available on request.

Precautions when connecting:

1 - Never connect or disconnect on the encoder or cubicle side, without turning the power off.

2 - For the supply, use stabilised, regulated and filtered supplies. The use of supplies using transformers delivering efficient 5 V (or 24 V) at their secondary, followed by filter chokes and condensers is prohibited, because, in reality, in the direct voltages thereby obtained are:

- for the 5 V : $5 \cdot \sqrt{2} = 7,07$ V
- for the 24 V : $24 \cdot \sqrt{2} = 33,936$ V

3 - Respect the international standards in force.



Asynchronous LSMV motor for speed variation Optional equipment

B2 - Brake option

B2.1 - BRAKE SELECTION

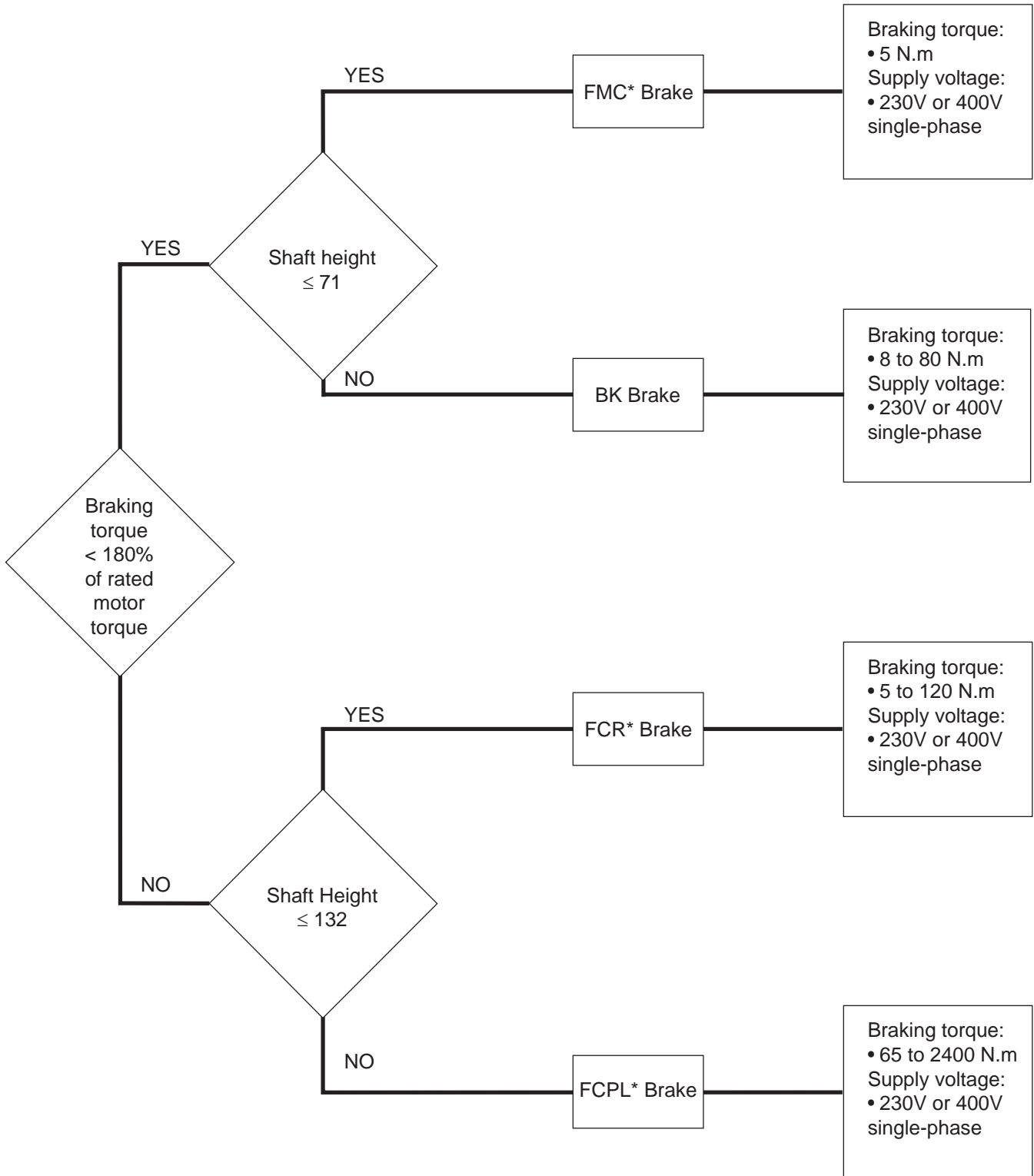

* FCR Brake: see asynchronous motor catalogue FCR brakes ref. 3305.
 FCPL Brake: see asynchronous motor catalogue FCPL brakes ref. 3463.
 FMC Brake: see motor brake catalogue.

Asynchronous LSMV motors for speed variation Optional equipment

B2 - Brake option

B2.2 - BK BRAKE

The BK Brake, current, loss brake, a single disc (1) with 2 friction faces, is used as a retarder brake and/or an emergency brake.

B2.2.1 - Operating principle:

A friction produced by several springs (2) generates a braking torque which allows different loads. The transmission of brake torque from the hub (4) to rotor (3) is effected through splines. The friction pads ensure a high braking torque with minimal wear. This component does not need maintenance or adjustment.

The release of the brake is achieved with an electromagnetic field produced by the coil (5) with voltage at its terminals. The brakes are delivered ready to use (airgap preadjusted) with the drive unit mounted in the terminal box. The "manual release" option is available on request.

B 2.2.2 - Supply under 230 V:

Unit type: S08

Rectified voltage: 210V full wave

Nominal voltage (wind brake): 185V

B2.2.3 - Supply under 400 V :

Unit type: S08

Rectified voltage: 210V single wave

Nominal voltage (wind brake): 185V

Terminal voltage (brake):

1) $U_{dc} = 0,45 \times U_{ac}$ (400V)

2) $U_{dc} = 0,9 \times U_{ac}$ (230V)

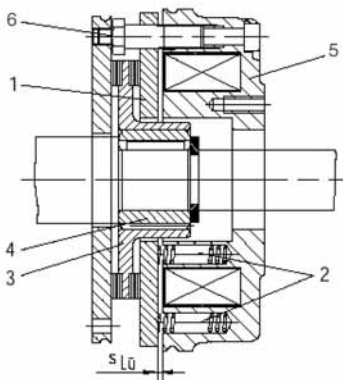

- 1 Armature disc
- 2 Pressure springs
- 3 Rotor
- 4 Hub
- 5 Coil housing body
- 6 Hollow bolts



Asynchronous LSMV motor for speed variation Optional equipment

B2 - Brake option

B2.2.4 - Characteristics:

Type	Power at 20 °C W	Resistance Ohm	Absorbed voltage mA	Braking torque			Max speed min ⁻¹
				100 min ⁻¹ N.m	1500 min ⁻¹ N.m	3000 min ⁻¹ N.m	
BK 08	25	1444	131,5	8	6,8	6,24	10100
BK 10	30	1203	157,8	16	9,96	9,12	8300
BK 12	40	902,5	210,5	32	25,92	23,68	6700
BK 14	50	722	263,1	60	48	43,8	6000
BK 16	60	601,7	315,7	80	63,2	57,6	5300

B2.2.5 - Operating time :

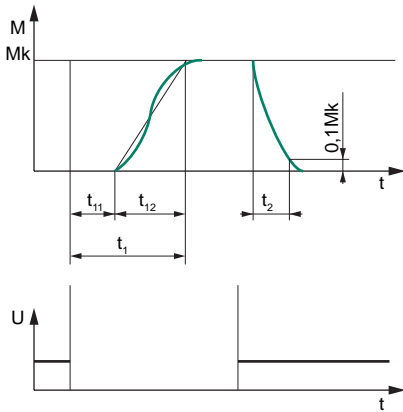

t_1 Engagement time
 t_2 Cut-off time (until $M = 0,1 M_k$)
 t_{11} Response delayed upon engagement
 t_{12} Torque incremental time

Type	Braking torque at 100 min ⁻¹ N.m	Friction max. J	Frequency of operations	Operating time			
				t_{11} ms	t_{12} ms	t_1 ms	t_2 ms
BK 08	8	7500	50	13	19	32	60
BK 10	16	12000	40	28	19	47	73
BK 12	32	24000	30	29	28	57	111
BK 14	60	30000	28	15	23	38	213
BK 16	80	36000	27	23	30	53	221

The passage of a brake torque to a permanent torque is effected by a certain delay. The release times correspond to switching direct current inducing a voltage approximately 5 to 10 times greater than the nominal voltage. The diagram on the side shows the delay in release time t_{11} , the increase in tor-

que time t_{12} , the engagement time $t_1 = t_{11} + t_{12}$ and the time t_2 .

The cut-off time is not modified by switching direct or alternative current side. It can be reduced by the application of rapid excitation or over-excitation cards.

B2.2.6 - Braking time / Max allowed inertia:

Type	Inertia at 1000 min ⁻¹ kg.m ²	Braking time ms	Inertia at 1500 min ⁻¹ kg.m ²	Braking time ms	Inertia at 3000 min ⁻¹ kg.m ²	Braking time ms
BK 08	1,367	17,89	0,607	12	0,152	6
BK 10	2,188	14,32	0,973	9,45	0,243	4,7
BK 12	4,37	14,3	1,945	9,547	0,486	4,7
BK 14	5,47	9,54	2,431	6,364	0,608	3,18
BK 16	6,565	8,59	2,92	5,73	0,73	2,86

B2.2.7 - Wiring diagram

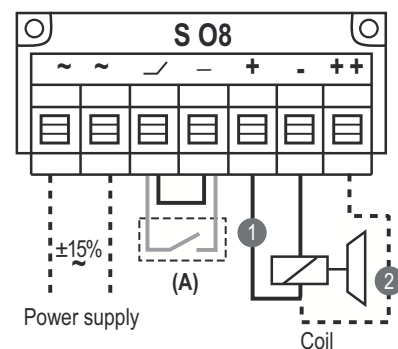

Power supply	Coil	Cabling*
400V AC	180V DC	①
230V AC	180V DC	②

*according power supply and coil

Asynchronous LSMV motors for speed variation Optional equipment

B2 - Brake option

B2.2.8 - Characteristic LSMV + BK / FMC* Brake

Brake supply: 230 V or 400 V AC / 205 V DC

2
poles

Motor type	Brake type	Rated power P_n kW	Maximum mechanical speed N_s min ⁻¹	Nominal torque M_N N.m	Braking torque M_f N.m	Brake consumption I_F A	Response time t_1 ms	DC* Cutoff decay time t_2 ms	Moment of inertia J kg.m ²	Weight kg
LSMV 71	FMC050	0,25	7200	0,8	5	0,13	30	35	CU	7,3
LSMV 71	FMC050	0,37	7200	1,2	5	0,13	30	35	CU	7,3
LSMV 71	FMC050	0,55	7200	1,8	5	0,13	30	35	CU	7,3
LSMV 80 L	BK 8	0,75	10100	2,4	8	0,13	32	60	0,001	15
LSMV 80 L	BK 8	1,1	10100	3,5	8	0,13	32	60	0,001	16
LSMV 90 L	BK 16	1,5	10100	4,8	16	0,15	47	73	0,002	21,9
LSMV 90 L	BK 16	2,2	8300	7	16	0,15	47	73	0,003	26,7
LSMV 100 L	BK 32	3	8300	9,5	32	0,21	57	111	0,004	33,7
LSMV 112 MG	BK 32	4	8300	12,7	32	0,21	57	111	0,011	44
LSMV 132 SM	BK 60	5,5	6700	17,5	60	0,26	38	213	0,016	73
LSMV 132 SM	BK 60	7,5	6700	23,8	60	0,26	38	213	0,018	82
LSMV 132 M	BK 60	9	6000	28,7	60	0,26	38	213	0,018	73
LSMV 160 MP	BK 80	11	5300	35,8	80	0,31	53	221	0,035	82
LSMV 160 MP	BK 80	15	5300	48,7	80	0,31	53	221	0,038	97

4
poles

Motor type	Brake type	Rated power P_n kW	Maximum mechanical speed N_s min ⁻¹	Nominal torque M_N N.m	Braking torque M_f N.m	Brake consumption I_F A	Response time t_1 ms	DC* Cutoff decay time t_2 ms	Moment of inertia J kg.m ²	Weight kg
LSMV 71	FMC050	0,18	7200	1,2	5	0,13	30	35	CU	6,4
LSMV 71	FMC050	0,25	7200	1,7	5	0,13	30	35	CU	6,4
LSMV 71	FMC050	0,37	7200	2,4	5	0,13	30	35	CU	7,3
LSMV 80 L	BK 8	0,75	10100	5	8	0,13	32	60	0,002	16
LSMV 90 SL	BK 16	1,1	8300	7,4	16	0,15	47	73	0,004	20,9
LSMV 90 L	BK 16	1,5	8300	10	16	0,15	47	73	0,005	22,9
LSMV 100 L	BK 32	2,2	6700	14,7	32	0,21	57	111	0,006	30
LSMV 100 L	BK 32	3	6700	19	32	0,21	57	111	0,008	33
LSMV 112 MG	BK 32	4	6700	26,8	32	0,21	57	111	0,016	41
LSMV 132 SM	BK 60	5,5	6000	36,7	60	0,26	38	213	0,033	66
LSMV 132 M	BK 60	7,5	6000	49,4	60	0,26	38	213	0,035	72
LSMV 132 M	BK 80	9	5300	58,8	80	0,31	53	221	0,039	82
LSMV 160 MR	BK 80	11	5300	71,7	80	0,31	53	221	0,069	110

6
poles

Motor type	Brake type	Rated power P_n kW	Maximum mechanical speed N_s min ⁻¹	Nominal torque M_N N.m	Braking torque M_f N.m	Brake consumption I_F A	Response time t_1 ms	DC* Cutoff decay time t_2 ms	Moment of inertia J kg.m ²	Weight kg
LSMV 90 S	BK 16	0,75	8300	7,5	16	0,15	47	73	0,004	20,9
LSMV 90 L	BK 16	1,1	8300	11,2	16	0,15	47	73	0,005	22,9
LSMV 100 L	BK 32	1,5	6700	15,4	32	0,21	57	111	0,006	28,7
LSMV 112 M	BK 32	2,2	6700	21	32	0,21	57	111	0,009	31
LSMV 132 SM	BK 60	3	6000	28,6	60	0,26	38	213	0,018	55
LSMV 132 M	BK 60	4	6000	40,8	60	0,26	38	213	0,052	66
LSMV 132 M	BK 60	5,5	6000	56	60	0,26	38	213	0,060	71

* FMC Brake: refer to the brake motor technical catalogue.

CU : consult us

Asynchronous LSMV motor for speed variation Optional equipment

B2 - Brake option

B2.3 - OTHER BRAKES: FCR - FCPL

FCR Brake: see asynchronous motor catalogue FCR brakes ref. 3305.

FCPL Brake: see asynchronous motor catalogue FCPL brakes ref. 3463.

B2.3.1 - Characteristics LSMV + FCR BRAKE:

Brake supply: 230 V or 400 V AC / 180 V DC

2
poles

Motor type	Brake type	Rated power	Maximum mechanical speed	Nominal torque	Braking torque	Brake consumption	Brake release response time	Brake applied response time	Brake applied response time cut in DC*	Moment of inertia	Weight
		P_n kW	N_s min ⁻¹	M_n N.m	M_l N.m	I_F A	t_1 ms	t_2 ms	t_2 ms	J kg.m ²	kg
LSMV 71 L	FCR J01	0,37				CU					12
LSMV 71 L	FCR J01	0,55				CU					13
LSMV 80 L	FCR J01	0,75	4000	2,4	10		80	85	≤ 10	1,9	16,8
LSMV 80 L	FCR J01	1,1	4000	3,5	10	0,31	80	85	≤ 10	2,1	18,8
LSMV 90 L	FCR J01	1,5	4000	4,8	20		150	140	≤ 10	3,5	26
LSMV 90 L	FCR J01	2,2	4000	7,1	20	0,35	150	140	≤ 10	4,1	28,4
LSMV 100 L	FCR J01	3	4000	9,7	25		150	140	≤ 10	4,7	33,4
LSMV 112 MG	FCR J01	4	4000	13	43		150	580	≤ 40	13,5	52
LSMV 132 SM	FCR J02	5,5	4000	18	80	0,44	280	620	≤ 90	50,6	78
LSMV 132 M	FCR J02	7,5	4000	24	80	0,5	280	620	≤ 90	55,9	87
LSMV 132 M	FCR J02	9				CU					97
LSMV 160 MP	FCR J02	11				CU					110

4
poles

Motor type	Brake type	Rated power	Maximum mechanical speed	Nominal torque	Braking torque	Brake consumption	Brake release response time	Brake applied response time	Brake applied response time cut in DC*	Moment of inertia	Weight
		P_n kW	N_s min ⁻¹	M_n N.m	M_l N.m	I_F A	t_1 ms	t_2 ms	t_2 ms	J kg.m ²	kg
LSMV 71 L	FCR J01	0,25	4000	1,68	5		60	90	≤ 10	2,1	11,5
LSMV 71 L	FCR J01	0,37	4000	2,49	5	0,27	60	90	≤ 10	2,5	12,5
LSMV 80 L	FCR J01	0,75	4000	5,12	10		80	85	≤ 10	3,4	16,6
LSMV 90 L	FCR J01	1,1	4000	7,35	20	0,31	150	140	≤ 10	5,7	22,7
LSMV 90 L	FCR J01	1,5	4000	10,03	20		150	140	≤ 10	6,7	24,7
LSMV 100 L	FCR J01	2,2	4000	14,5	25	0,35	150	140	≤ 10	6,9	30
LSMV 100 L	FCR J01	3	4000	19,5	25		150	140	≤ 10	8,9	33
LSMV 112 MG	FCR J01	4	4000	26,56	43		150	580	≤ 40	19,3	49,3
LSMV 132 SM	FCR J02	5,5	4000	36,3	80	0,44	280	620	≤ 90	60,4	71,3
LSMV 132 M	FCR J02	7,5	4000	49,4	80	0,5	280	620	≤ 90	62	77,3
LSMV 132 M	FCR J02	9	4000	59,3	105		280	620	≤ 90	65,5	80
LSMV 160 MR	FCR J02	11	4000	72,2	120	0,79	280	550	≤ 90	96	102

* Brake applied response time, with no applied voltage, when the continuous current (dc) circuit is cut.

CU : consult us

Asynchronous LSMV motors for speed variation Optional equipment

B2 - Brake option

B2.3.2 - Characteristics LSMV + FCPL Brake:

Brake supply: 230 V or 400 V AC / 100 V or 180 V DC

4
poles

Motor type	Brake type	Rated power P_n kW	Maximum mechanical speed N_s min ⁻¹	Nominal torque M_N N.m	Braking torque M_f N.m	Brake consumption I_F A	Response time t_1 ms	DC* Cutoff decay time t_2 ms	Moment of inertia J kg.m ²	Weight kg
LSMV 160 MR	40 - 112	11	4000	72	125	0,5	287	97	0,06	105
LSMV 160 LU	54 - 215	15	4000	98	150	0,5	195	60	0,12	150
LSMV 180 M	54 - 318	18,5	4000	121	180	0,5	234	50	0,17	200
LSMV 180 LU	54 - 222	22	4000	144	220	0,5	286	40	0,17	205
LSMV 200 L	60 - 330	30	4000	196	300	0,6	300	60	0,31	255
LSMV 225 SR	60 - 239	37	4000	240	390	0,6	195	90	0,37	320
LSMV 225 MG	60 - 152	45	4000	293	520	0,6	260	70	0,75	400
LSMV 250 ME	60 - 260 ¹	55	4000	354	600 ²	0,6	300	60	0,99	420
LSMV 280 SD	88 - 180 ¹	75	CU	476	800 ²	1,6	150	150	1,13	600
LSMV 280 MK	88 - 195 ¹	90	CU	577	950 ²	1,6	150	150	2,79	860

6
poles

Motor type	Brake type	Rated power P_n kW	Maximum mechanical speed N_s min ⁻¹	Nominal torque M_N N.m	Braking torque M_f N.m	Brake consumption I_F A	Response time t_1 ms	DC* Cutoff decay time t_2 ms	Moment of inertia J kg.m ²	Weight kg
LSMV 160 M	40 - 112	7,5	4000	73	125	0,5	287	97	0,10	120
LSMV 160 L	54 - 318	11	4000	109	180	0,5	234	50	0,14	140
LSMV 180 L	60 - 126	15	4000	146	260	0,6	260	110	0,23	200
LSMV 200 LT	60 - 230 ¹	18,5	4000	182	300	0,6	300	60	0,28	240
LSMV 200 LU	60 - 239	22	4000	215	390	0,6	195	90	0,37	280
LSMV 225 MG	60 - 152	30	4000	295	520	0,6	260	70	0,48	320
LSMV 250 ME	60 - 260 ¹	37	4000	362	600 ²	0,6	300	60	0,99	385
LSMV 280 SC	88 - 180 ¹	45	CU	436	800 ²	1,6	150	150	1,27	510
LSMV 280 MC	88 - 195 ¹	55	CU	541	950 ²	1,6	150	150	1,46	555

1. Requires a CDF brake mains supply card.
2. If higher torque is needed, please consult.

* Brake applied response time, with no applied voltage, when the continuous current (dc) circuit is cut.

CU : consult us

Asynchronous LSMV motor for speed variation Optional equipment

B3 - Forced ventilation option

The forced ventilation option enables:

- Continuous operation at zero speed with a torque equal to the motor's nominal torque at 50 Hz.
- Operation at overspeed:
where $n > 2600 \text{ min}^{-1}$ at 4 and 6p
where $n > 4500 \text{ min}^{-1}$ at 2p

It is also imperative in the following cases:

- When used with encoders without a through shaft (see, B.1.2.4).
- LSMV motor 6p for constant torque applications at $n < 25\text{Hz}$

HA	Supply voltage ¹	Consumption		Protection index ²
		P (W)	I (A)	
LSMV 71	single-phase 230V	20	0,20	IP 55
LSMV 80	single-phase 230 ou 400V	107	0,82/0,47	IP 55
LSMV 90 à 132	single-phase 230 ou 400V	100	0,75/0,43	IP 55
LSMV 160 to 225 in 6p LSMV 160 to 280S in 4p	three-phase 230/400V 50Hz 254/460V 60Hz	150	0,94/0,55	IP 55
LSMV 250 to 315 in 6p LSMV 280M and 315 in 4p	three-phase 230/400V 50Hz 254/460V 60Hz	200	1,4/0,8	IP 55
LSMV 315M	three-phase 230/400V 50Hz 254/460V 60Hz	750	3,6/2,1	IP 55
LSMV FMC	single-phase 230 ou 400V	CU		IP 55
LSMV FCR	single-phase 230 ou 400V	CU		IP 55
LSMV FCPL	three-phase 230/400V 50Hz 254/460V 60Hz	CU		IP 55

1. $\pm 10\%$ of voltage, $\pm 2\%$ of frequency.

2. Protection index of the forced ventilation mounted on the motor.

CU : consult us

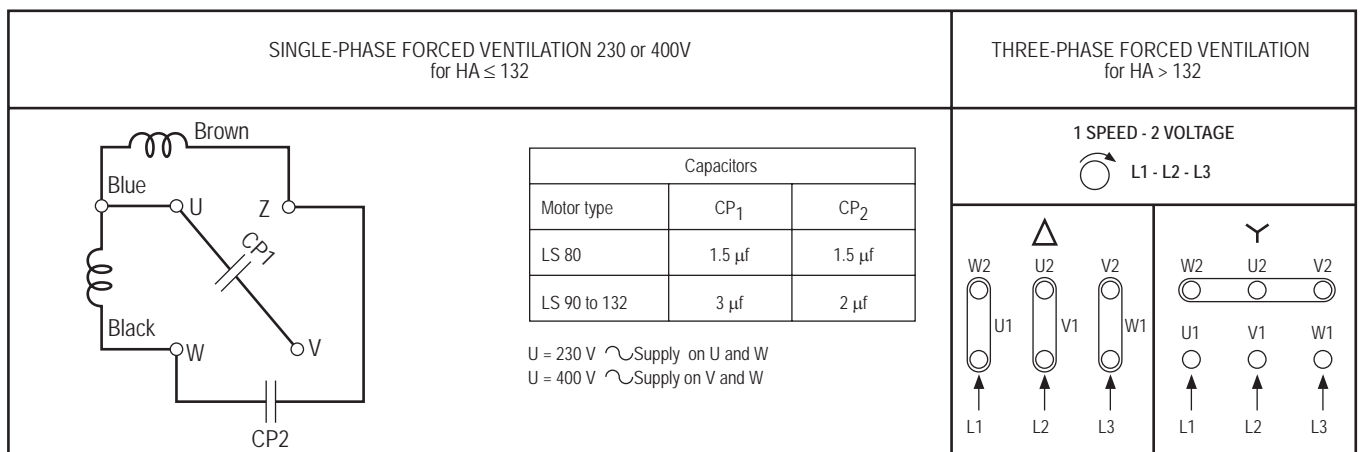

Asynchronous LSMV motors for speed variation Optional equipment

B4 - Reinforced insulation

The standard motors within the **LSMV** range are compatible with the supply characteristics as follows:

$U = 480V$ max.

- Value of the voltage peak withstand capability at the motor terminal: $1500V$ at $dv/dt = 5kV/\mu s$.

- Switching frequency: $2,5$ kHz min.

However they can be supplied for more severe conditions with additional protection.

B4.1 - REINFORCED INSULATION OF THE WINDING

The main effect associated with supplying power via an electronic drive is overheating of the motor due to the non-sinusoidal shape of the signal. In addition, this can also cause the winding to age more quickly because of the voltage peaks generated at each pulse in the power supply signal (see fig 1).

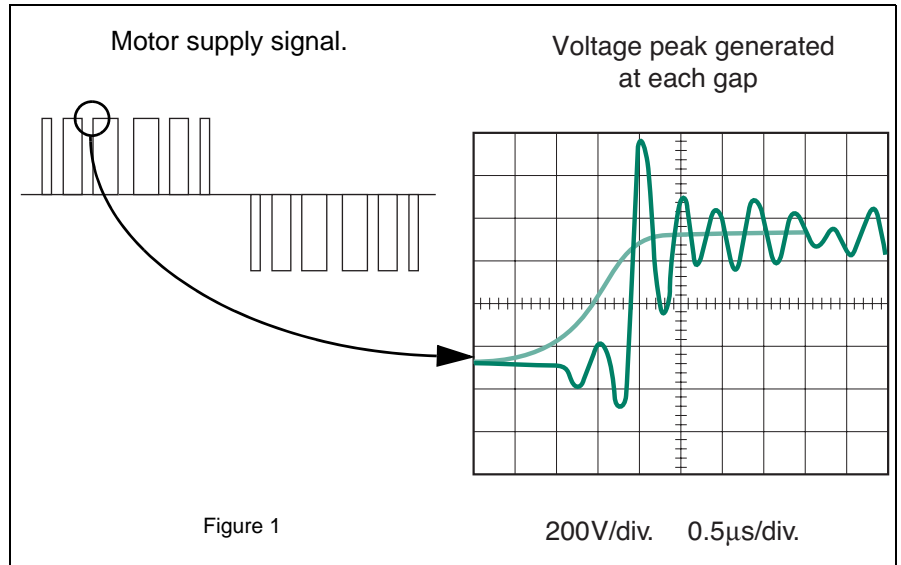

B4.2 - REINFORCED INSULATION OF THE MECHANICAL PARTS

The same inverter supply that has damaging effect on the winding of a motor, can impact the mechanical parts as well by additionally injecting circulating currents that already exist in the network supplied motors.

This can lead to premature wear of the bearings. In all asynchronous motors there exists a shaft voltage in relation to earth. This voltage which is predominantly due to asymmetry in the air-gap, excites a current, which circulates in the rotor and finds a path through the endshields into the bearings. This current can produce, via the oil film, electrical discharges between the ball and race reducing the life-span of the bearing.

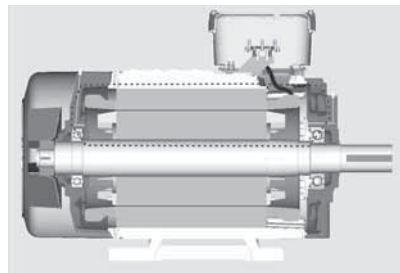

In the case of a PWM inverter supply, the current values are increased and accentuates the phenomena.

A second phenomena can also occur: high frequency currents generated by the semiconductor (Insulated Gate Bipolar Transistors - IGBT) bridge at the output of the inverter.

These currents "seek" to find a return path towards the inverter and pass through stator frame and earth if the contact between these parts is correctly made.

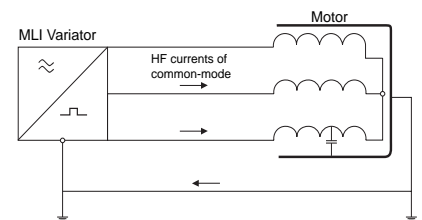

Otherwise, the currents will take a path of least resistance i.e end-shields, bearings, shaft and driven machine coupled to the motor. In this case, the protection of the bearings must be considered.

An "insulated bearing" option is available through the **LSMV** range from frame size 160 and above. The bearing is normally fitted on the non-drive end side.

Characteristics of insulated bearings:

The external bearing rings are coated with an electrical insulated ceramic. The dimensions as well as the tolerances of these bearings are identical to the standards used and therefore can be mounted in their place without modification to the motors. The maximum voltage is $500V$.

B5 - Cable gland

In certain applications, it is necessary to ensure a continuity of ground between the cable and the weight of the motor in order to insure a protection of the installation conforming to CEM 89/336/CEE.

A cable gland option with anchoring on the armed cable is available throughout the LSMV range (Std on LSMV 71).

Asynchronous LSMV motor for speed variation Optional equipment

B6 - Thermal protection

The LSMV motors are CTP equipped by standard

Motor protection is assured by a thermomagnetic circuit breaker, manually or automatically operated, placed between the selector and the motor. This circuit breaker can be supplemented with fuses.

This protection equipment insures global protection of the motors against low variation

over-loads. If a reduction in the reaction time is required, if detection of an instantaneous over-load is wanted, or to follow the evolution of the temperature at the "hot points" of the motor or at characteristic points for maintenance of the installation, it is recommended to install heat protection sensors

positioned at sensitive points. Their type and description are described in the chart below. **It is underlined that under no circumstances these sensors are to be used to directly control the motor's duty cycle.**

Indirect incorporated thermal protection

Type	Operating principal	Operating curve	Cut-off power (A)	Assured protection	Number of apparatus fitted*
Thermal protection normally closed PTO	Bi-metallic with indirect heating and contact to open (O) 		2.5 A under 250 V to $\cos \phi 0.4$	global monitoring slow over-loads	Mounting in a control circuit 2 or 3 in series
Thermal protection normally closed PTF	Bi-metallic with indirect heating and contact to close (F) 		2.5 A under 250 V to $\cos \phi 0.4$	global monitoring slow over-loads	Mounting in a control circuit 2 or 3 in parallel
Thermistor with a positive temperature co-efficient CTP	Variable non-linear resistance by indirect heating 		0	global monitorings fast over-loads	Mounting with associated relay in control circuit 3 in series
Thermal sensor KT Y	Resistance depends on the winding temperature 		0	continuous high precision monitoring of key hot points	Mounting in control board with associated reading apparatus (or recorder) 1/point to be monitored
Thermocouples T ($T < 150\text{ }^{\circ}\text{C}$) Copper Constantan K ($T < 1000\text{ }^{\circ}\text{C}$) Copper Copper-Nic-	Peltier effect		0	continuous monitoring of specific hot points	Mounting in control board with associated reading apparatus (or recorder) 1/point to be monitored
Thermal sensor with platinum PT 100	Variable linear resistance by indirect heating		0	continuous high precision monitoring of key hot points	Mounting in control board with associated reading apparatus (or recorder) 1/point to be monitored

- TNF: nominal operating temperature

- The TNF are chosen according to the implantation of the sensor in the motor and the temperature rise class.

* The number of apparatus concerns the protection of the winding.

Mounting of the different protections

- PTO or PTF, in the control circuit.
- CTP, with associated relay, in the control circuits.
- PT 100 or thermocouples, with associated reading apparatus (or recorder), in the installation control board for continuous monitoring.

Alarm and pre-alarm

All protection equipment may be doubled (with different TNF): the first equipment serves as a pre-alarm (light or sound signals, without power circuit cut-off), the second used as an alarm (assuring the cut-off of power supply).

Asynchronous LSMV motors for speed variation Optional equipment

B7 - Varmeca option

The Varmeca is a frequency inverter with flux vector control operating on all of the supply networks (200 V to 480 V 50/60 Hz). Mechanically it is mounted in place of the terminal box.

The assembly enables operation at constant torque, at low speed and at constant power at high speed (forced ventilation option obli-

gatory). In all cases the Varmeca enables the management of the CTP and PTO motor sensors.

The motor-inverter offers a decentralised solution on the machine, the product being designed to operate in an industrial environment (electronics encapsulated in resin).

A number of options may be integrated:

local speed control, forward and reverse drive, display, braking resistance; field bus. Varmeca conforms to the European standards CE mark as well as North America, UL for the USA and c(UL)us for Canada.



B8 - Connectable plug option

The connectable plug option allows a simple, fast and secured motor connection.

It can be used in a number of processes (automobile, food industries...) where machinery replacement time must be minimised.

The male part of the connector is mounted in place of or on the motor terminal box, depending on the other selected options.

The connector plug is connected to the stator coil.

The female part of the connector is attached to the supply network.

Up to 10 contacts can be mounted on the connectors, covering powers up to 11 kW to the acceptable maximum current limit of 40 A. For higher powers please consult.

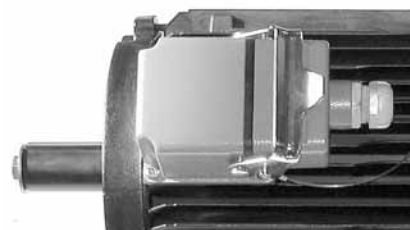

Asynchronous LSMV motors for speed variation Electrical characteristics

PAGES

C1 - Selection table

2 poles	28-29
4 poles	30-31
6 poles	32-33



Asynchronous LSMV motors for speed variation Electrical characteristics

C1 - Selection table

2
poles

IP 55 - S1
Cl. F - ΔT 80 K

SUPPLY 400 V Y

50 Hz

Type	Rated power at 50 Hz	Rated speed	Rated torque	Rated current	No load current	Power factor	Efficiency	Maximum torque / Rated torque	Moment of inertia	Weight
	P_n kW	N_N min ⁻¹	C_n N.m	$I_N(400V)$ A	I_O A	$\cos \varphi$	η	M_M / M_N	J kg.m ²	IM B3 kg
LSMV 71 L	0,25	2905	0,82	0,75	0,65	0,67	72	5,9	0,000675	7,3
LSMV 71 L	0,37	2900	1,22	1,07	0,85	0,68	73	4,8	0,000675	7,3
LSMV 71 L	0,55	2890	1,82	1,42	0,95	0,73	77	4,2	0,00085	7,3
LSMV 80 L	0,75	2865	2,5	1,6	0,69	0,88	80	2,6	0,0009	11
LSMV 80 L	1,1	2880	3,7	2,2	1	0,87	83	2,7	0,0011	12,5
LSMV 90 L	1,5	2885	5	2,9	1,1	0,9	83	3,9	0,0017	18,5
LSMV 90 L	2,2	2900	7,1	4,6	2,35	0,85	83	4	0,0023	21
LSMV 100 L	3	2875	9,9	5,7	2,4	0,89	84	3,6	0,0029	26
LSMV 112 MG	4	2900	13,2	7,5	2,29	0,92	84	3	0,0092	36
LSMV 132 SM	5,5	2915	18	10,1	2,73	0,91	86	3,1	0,016	63
LSMV 132 M	7,5	2910	24,5	13,6	3,2	0,92	86	2,8	0,018	72
LSMV 132 M	9	2940	29,3	16,6	6,5	0,88	88,5	3,6	0,018	80
LSMV 132 M	11	2935	36	20,6	8,6	0,87	0,89	3,96	0,020	80
LSMV 160 MP	11	2935	35,8	20,6	8,6	0,87	89	4	0,035	72
LSMV 160 MR	15	2950	48,7	28	12	0,86	90	4,1	0,038	87

Asynchronous LSMV motors for speed variation Electrical characteristics

C1 - Selection table

Type	SUPPLY 380 V Y 50 Hz						SUPPLY 415 V Y 50 Hz					SUPPLY 460 V Y 60 Hz					
	Rated power at 50 Hz	Rated speed	Rated current	No load current	Power factor	Efficiency	Rated speed	Rated current	No load current	Power factor	Efficiency	Rated power at 60 Hz	Rated speed	No load speed	Rated current	Power factor	Efficiency
	P_n kW	N_N min ⁻¹	I_N A	I_O A	$\cos \varphi$	η	N_N min ⁻¹	I_N A	I_O A	$\cos \varphi$	η	P_n kW	N_N min ⁻¹	I_O A	I_N A	$\cos \varphi$	η
LSMV 71 L	0,25	2895	0,73	0,58	0,71	73	2912	0,77	0,7	0,63	72	0,3	3500	0,57	0,75	0,67	72,3
LSMV 71 L	0,37	2888	1,04	0,75	0,73	74	2908	1,11	0,95	0,64	73	0,44	3500	0,78	1,07	0,68	73,4
LSMV 71 L	0,55	2874	1,43	0,84	0,78	75	2898	1,46	1,05	0,69	76	0,66	3490	0,85	1,42	0,73	76,6
LSMV 80 L	0,75	2845	1,6	0,68	0,9	78	2880	1,5	0,73	0,87	80	0,9	3455	0,6	1,6	0,9	79
LSMV 80 L	1,1	2860	2,3	1	0,87	83	2885	2,2	1,25	0,82	83	1,3	3475	1,1	2,4	0,86	84
LSMV 90 L	1,5	2885	2,9	1,1	0,9	84	2895	2,9	1	0,9	83	1,8	3470	1	3,1	0,93	78
LSMV 90 L	2,2	2880	4,6	2,1	0,87	85	2900	4,5	3	0,78	85	2,6	3475	2,1	4,6	0,87	86
LSMV 100 L	3	2850	6	2,1	0,91	84	2880	5,7	2,78	0,87	84	3,7	3440	2,1	6,5	0,92	82
LSMV 112 MG	4	2900	7,5	2,41	0,92	84	2910	7,3	2,3	0,92	86	4,8	3485	2,1	7,7	0,93	84
LSMV 132 SM	5,5	2900	10,7	2,68	0,91	82	2925	9,8	3	0,9	88	6,6	3500	2,8	10,7	0,91	87
LSMV 132 M	7,5	2900	14	3,4	0,92	86	2920	13,1	3,7	0,89	90	9	3500	3,4	14,1	0,93	88
LSMV 132 M	9	2935	17,3	5,5	0,89	89	2950	16,2	7,6	0,87	89	11	3515	5,7	17,6	0,9	87,2
LSMV 132 M	11	2950	21	6,9	0,9	88	2950	20,7	10,1	0,83	89	13,2	3525	6,9	20,9	0,89	89
LSMV 160 MP	11	2935	20,6	10,3	0,84	91	2940	20,7	8,3	0,87	89	13	3525	6,3	20,9	0,89	89
LSMV 160 MR	15	2950	28	12,6	0,86	90	2955	28,2	11,6	0,86	90	18	3545	9,4	28	0,89	90

Asynchronous LSMV motors for speed variation Electrical characteristics

C1 - Selection table

4
poles

IP 55 - S1
Cl. F - ΔT 80 K

SUPPLY 400 V Y

50 Hz

Type	Rated power at 50 Hz	Rated speed	Rated torque	Rated current	No load current	Power factor	Efficiency	Maximum torque / Rated torque	Moment of inertia	Weight
	P_n kW	N_N min ⁻¹	C_n N.m	$I_N(400V)$ A	I_O A	$\cos \varphi$	η	M_M / M_N	J kg.m ²	IM B3 kg
LSMV 71 L	0,18	1455	1,19	0,67	0,65	0,57	69	4	0,000675	6,4
LSMV 71 L	0,25	1450	1,68	0,91	0,8	0,58	70	4,1	0,000675	6,4
LSMV 71 L	0,37	1452	2,44	1,3	1,2	0,58	71	3,8	0,00085	7,3
LSMV 80 L	0,55	1420	3,7	1,65	1,32	0,71	68	3,2	0,0013	8,2
LSMV 80 L	0,75	1435	4,9	2	1,43	0,71	77	3,1	0,0024	11
LSMV 90 SL	1,1	1445	7,2	2,5	1,33	0,82	79	2,4	0,0039	17
LSMV 90 L	1,5	1435	9,9	3,2	1,54	0,84	80	2,3	0,0050	22
LSMV 100 L	2,2	1440	14,6	4,7	2,27	0,83	81	2,7	0,00615	25
LSMV 100 L	3	1430	19,4	6,3	3,1	0,82	81	2,9	0,0071	24
LSMV 112 MG	4	1460	26	8,4	4,6	0,8	85	3,2	0,015	33,3
LSMV 132 SM	5,5	1460	37	10,4	4,4	0,87	86	3,3	0,0334	48
LSMV 132 M	7,5	1455	49,4	14	4,7	0,89	87	2,8	0,035	54
LSMV 132 M	9	1460	58,8	16,8	6,5	0,88	88	3,1	0,0385	65
LSMV 160 MR	11	1460	71,7	20,2	6,6	0,88	89	3,2	0,069	100
LSMV 160 LU	15	1465	97,8	28,3	11,7	0,85	90,7	3,8	0,093	109
LSMV 180 M	18,5	1468	120	34,4	14,1	0,84	92,4	3	0,123	136
LSMV 180 LU	22	1468	143	40,7	16,9	0,84	92,8	3,2	0,145	155
LSMV 200 L	30	1476	194	55,8	22,9	0,83	93	3	0,24	200
LSMV 225 SR	37	1474	240	68,1	26,2	0,84	93,3	2,9	0,29	235
LSMV 225 MG	45	1483	290	82,9	34,9	0,83	94,3	3,2	0,63	320
LSMV 250 ME	55	1481	354	100	38,5	0,84	94,2	2,9	0,73	340
LSMV 280 SD	75	1482	483	137,1	55,1	0,83	94,9	3,2	0,96	430
LSMV 280 MK	90	1488	577	161	58,1	0,85	95,2	3,3	2,32	655
LSMV 315 SP	110	1489	706	200	81	0,84	95,4	3,6	2,79	750
LSMV 315 MR	132	1490	846	242	102	0,83	95	3,8	3,25	860

Asynchronous LSMV motors for speed variation Electrical characteristics

C1 - Selection table

Type	SUPPLY 380 V Y						SUPPLY 415 V Y					SUPPLY 460 V Y					
	50 Hz						50 Hz					60 Hz					
	Rated power at 50 Hz	Rated speed	Rated current	No load current	Power factor	Efficiency	Rated speed	Rated current	No load current	Power factor	Efficiency	Rated power at 60 Hz	Rated speed	Rated current	No load speed	Power factor	Efficiency
P_n kW	N_N min ⁻¹	I_N A	I_O A	$\cos \varphi$	η	N_N min ⁻¹	I_N A	I_O A	$\cos \varphi$	η	P_n kW	N_N min ⁻¹	I_N A	I_O A	$\cos \varphi$	η	
LSMV 71 L	0,18	1450	0,64	0,6	0,61	70	1459	0,7	0,7	0,53	68	0,22	1755	0,67	0,6	0,57	69
LSMV 71 L	0,25	1445	0,88	0,75	0,61	71	1453	0,95	0,91	0,54	69	0,3	1750	0,91	0,75	0,58	70
LSMV 71 L	0,37	1447	1,24	1,1	0,62	72	1451	1,37	1,05	0,55	69	0,44	1750	1,3	1,1	0,58	71
LSMV 80 L	0,55	1420	1,65	1,32	0,71	68	1420	1,65	1,3	0,71	68	0,66	1720	1,65	1,2	0,73	70
LSMV 80 L	0,75	1420	2	1,43	0,72	76	1440	2,1	1,5	0,7	73	0,9	1720	2	1,3	0,73	78
LSMV 90 SL	1,1	1435	2,5	1,24	0,85	78	1450	2,4	1,48	0,8	79	1,32	1735	2,5	1,2	0,83	80
LSMV 90 L	1,5	1435	3,2	1,62	0,84	80	1440	3,2	1,67	0,82	80	1,8	1725	3,3	1,4	0,85	81
LSMV 100 L	2,2	1430	4,9	2,1	0,87	81	1445	4,6	2,66	0,82	81	2,64	1730	4,7	1,8	0,87	82
LSMV 100 L	3	1425	6,6	2,9	0,88	82	1430	6,4	3,26	0,81	82	3,6	1725	6,4	2,9	0,85	84
LSMV 112 MG	4	1455	8,5	4	0,83	85	1465	8,5	5,32	0,77	85	4,8	1755	8,4	4,1	0,83	86
LSMV 132 SM	5,5	1455	10,9	3,5	0,89	87	1465	10,5	5,8	0,82	87	6,6	1760	10,6	3,6	0,89	88
LSMV 132 M	7,5	1450	14,6	4,1	0,9	87	1460	13,7	7,1	0,83	86	9	1750	14,9	5,1	0,87	88
LSMV 132 M	9	1460	16,8	6,8	0,88	88	1465	16,6	7,2	0,86	88	11	1755	17,3	5,7	0,9	88,4
LSMV 160 MR	11	1455	20,9	6	0,9	89	1465	19,8	6,4	0,88	89	13,2	1755	20,6	6	0,89	90
LSMV 160 LU	15	1460	29,4	10,9	0,86	90,2	1468	27,7	12,5	0,83	90,8	17	1760	27,5	11,3	0,85	91,2
LSMV 180 M	18,5	1463	35,5	12,7	0,86	92,1	1471	33,8	15,4	0,82	92,4	21	1765	33,3	13,2	0,85	93
LSMV 180 LU	22	1463	42	15,2	0,86	92,5	1471	40,2	18,5	0,82	93	25	1765	39,5	15,8	0,85	93,3
LSMV 200 L	30	1472	57,6	21	0,85	92,8	1478	54,7	24,5	0,82	93,1	34,5	1775	55	21,7	0,85	93
LSMV 225 SR	37	1470	70,7	24,1	0,85	93	1476	66,9	28,2	0,82	93,4	42	1772	66	24	0,85	93,8
LSMV 225 MG	45	1481	85,6	31,9	0,85	94,1	1485	81,6	37,3	0,81	94,3	52	1782	82	32,3	0,84	94,4
LSMV 250 ME	55	1478	103	35,3	0,86	94,2	1483	97,9	41,2	0,83	94,4	63	1780	98	36,6	0,85	94,4
LSMV 280 SD	75	1479	141	50	0,85	94,8	1484	134,8	59,5	0,82	94,9	86	1780	134	51	0,84	95,1
LSMV 280 MK	90	1486	167	54,6	0,86	95,2	1488	156,6	61	0,84	95,3	103	1785	159	56	0,85	95,2
LSMV 315 SP	110	1487	205	75,4	0,85	95,4	1490	194	85,4	0,83	95,4	126	1788	195	77,8	0,85	95,4
LSMV 315 MR	132	1488	249,3	95,5	0,85	95	1490	237,9	108,9	0,81	94,9	152	1789	237,4	94,5	0,84	95,3



Asynchronous LSMV motors for speed variation Electrical characteristics

C1 - Selection table

6
poles

IP 55 - S1
Cl. F - ΔT 80 K

SUPPLY 400 V Y

50 Hz

Type	Rated power at 50 Hz	Rated speed	Rated torque	Rated current	No load current	Power factor	Efficiency	Maximum torque / Rated torque	Moment of inertia	Weight
	P_n kW	N_N min ⁻¹	C_n N.m	$I_N(400V)$ A	I_0 A	$\cos \varphi$	η	M_M / M_N	J kg.m ²	IM B3 kg
LSMV 90 S	0,75	930	7,8	2,1	1,58	0,77	68	2,6	0,0039	17
LSMV 90 L	1,1	915	11,4	3	2,1	0,75	70	2,5	0,0048	14
LSMV 100 L	1,5	905	15,8	4,2	3,4	0,74	70	2,7	0,0058	24
LSMV 112 M	2,2	905	22,6	5,8	4,2	0,76	72	2,5	0,0087	35
LSMV 132 S	3	945	30,6	7,1	3,6	0,78	81	2,5	0,0177	55
LSMV 132 M	4	960	40,8	9,3	5	0,75	84	2,8	0,0034	55
LSMV 132 M	5,5	960	56,3	13,7	7,6	0,71	84	2,7	0,0039	55
LSMV 160 M	7,5	969	74	16,3	8,9	0,77	86,5	2,5	0,088	77
LSMV 160 L	11	968	109	23,5	12,8	0,77	86,9	2,6	0,115	85
LSMV 180 L	15	972	147	30,1	14,5	0,81	88,1	2,8	0,123	135
LSMV 200 LT	18,5	970	182	37,1	18,2	0,81	89	2,8	0,235	160
LSMV 200 LU	22	980	214	44,9	21,3	0,77	91,4	3,1	0,354	225
LSMV 225 MG	30	982	292	58,4	26,2	0,80	92,3	2,8	0,787	290
LSMV 250 ME	37	980	361	71,1	30,1	0,81	92,7	2,5	0,854	305
LSMV 280 SC	45	979	439	86	37,6	0,81	92,7	2,7	0,991	340
LSMV 280 MC	55	977	538	104	42,8	0,82	92,8	2,6	1,191	385
LSMV 315 SP	75	980	731	140	59,9	0,83	93,3	3	3,084	660
LSMV 315 MP	90	980	877	165	59,8	0,84	93,4	3	3,76	760

Asynchronous LSMV motors for speed variation Electrical characteristics

C1 - Selection table

Type	SUPPLY 380 V Y						SUPPLY 415 V Y					SUPPLY 460 V Y					
	50 Hz						50 Hz					60 Hz					
	Rated power at 50 Hz	Rated speed	Rated current	No load current	Power factor	Efficiency	Rated speed	Rated current	No load current	Power factor	Efficiency	Rated power at 60 Hz	Rated speed	Rated current	No load speed	Power factor	Efficiency
P_n kW	N_N min ⁻¹	I_N A	I_O A	$\cos \varphi$	η	N_N min ⁻¹	I_N A	I_O A	$\cos \varphi$	η	P_n kW	N_N min ⁻¹	I_N A	I_O A	$\cos \varphi$	η	
LSMV 90 S	0,75	915	2,1	1,4	0,81	69	935	2,1	1,8	0,73	67	0,9	1125	2,1	1,4	0,76	0,7
LSMV 90 L	1,1	895	3	1,85	0,8	70	920	3,1	2,4	0,71	69	1,3	1100	2,9	1,83	0,78	73
LSMV 100 L	1,5	890	4,1	2,8	0,8	70	910	4,3	3,7	0,71	69	1,8	1100	4,1	2,8	0,76	73
LSMV 112 M	2,2	895	5,8	3,5	0,81	72	915	6	4,8	0,72	71	2,64	1100	5,6	3,5	0,78	74
LSMV 132 S	3	935	7,3	3,1	0,81	80	950	7,1	3,9	0,76	81	3,6	1145	7	3,2	0,79	82
LSMV 132 M	4	950	9,4	4,5	0,78	83	960	9,2	5,7	0,72	83	4,8	1155	9,3	4,6	0,76	85
LSMV 132 M	5,5	950	14	6,6	0,74	84	960	13,7	5,6	0,68	84	6,6	1155	13,8	6,9	0,73	85
LSMV 160 M	7,5	965	16,6	8,1	0,80	86,3	972	16,2	9,7	0,74	86,6	8,6	1167	15,7	8,2	0,78	87,8
LSMV 160 L	11	964	24	11,4	0,80	86,6	971	23,5	14,3	0,75	86,9	12,7	1166	22,8	11,6	0,79	88,1
LSMV 180 L	15	970	31,1	13,2	0,83	87,9	972	29,8	19,1	0,79	88,2	17	1172	29,7	13,8	0,81	88,2
LSMV 200 LT	18,5	965	38,3	16,7	0,83	89	974	36,4	19,3	0,79	89,6	21	1170	35,8	16,5	0,82	89,8
LSMV 200 LU	22	977	46,1	19,2	0,80	91,2	981	44,5	23,1	0,75	91,4	25	1178	44	19,5	0,79	91,9
LSMV 225 MG	30	978	60,5	24,3	0,82	92	983	57,4	27,6	0,79	92,5	34,5	1179	57	25,4	0,81	92,6
LSMV 250 ME	37	975	73,8	28	0,83	92	981	69,7	32,2	0,79	93	42	1177	69	28,4	0,82	93
LSMV 280 SC	45	974	89,2	34,7	0,83	92,3	981	84,4	40	0,8	92,9	52	1176	84,2	35	0,83	93
LSMV 280 MC	55	972	108	39,5	0,83	92,3	979	102	45,4	0,81	93	63	1174	102	40	0,83	93,1
LSMV 315 SP	75	977	145	55,6	0,84	93	982	138	63,5	0,81	93,4	86	1778	138	56,5	0,84	93,4
LSMV 315 MP	90	976	172	55,7	0,85	93,1	982	161	63,2	0,83	93,5	103	1177	163	58,8	0,85	93,4



Asynchronous LSMV motors for speed variation Dimensions

PAGES

D1 - Shaft ends 36

D2 - Foot mounted IM B3 (IM 1001) 37

D3 - Foot and flange mounted with plain holes IM B35 (IM 2001) 38

D4 - Flange mounted with plain holes IM B5 (IM 3001) 39

D5 - Foot and flange mounted with tapped holes IM B34 (IM 2101) 40

D6 - Flange mounted with tapped holes IM B14 (IM 3601) 41

D7 - Overall dimensions of options 42-43



Asynchronous LSMV motors for speed variation Dimensions

D1 - Shaft ends

Dimensions in millimetres

Overall dimensions of totally enclosed three-phase LSMV - IP 55 asynchronous motors without options

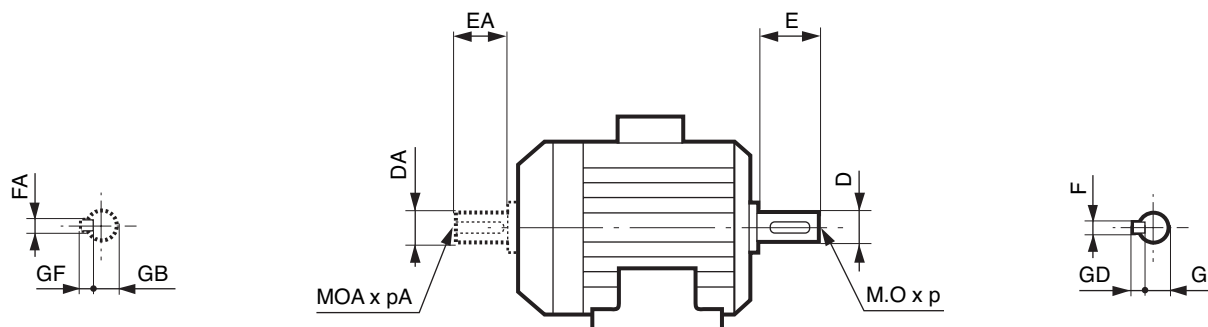

Type	Main shaft end													
	4 and 6 poles							2 poles						
	F	GD	D	G	E	O	p	F	GD	D	G	E	O	p
LSMV 71 L	5	5	14j6	11	30	5	15	5	5	14j6	11	30	5	15
LSMV 80 L	6	6	19j6	15,5	40	6	16	6	6	19j6	15,5	40	6	16
LSMV 90 S/L/SL	8	7	24j6	20	50	8	19	8	7	24j6	20	50	8	19
LSMV 100 L	8	7	28j6	24	60	10	22	8	7	28j6	24	60	10	22
LSMV 112 M/MG	8	7	28j6	24	60	10	22	8	7	28j6	24	60	10	22
LSMV 132 S/SM/M	10	8	38k6	33	80	12	28	10	8	38k6	33	80	12	28
LSMV 160 MR/MP/ML/LU	12	8	42k6	37	110	16	36							
LSMV 180 M/L/LU	14	9	48k6	42,5	110	16	36							
LSMV 200 LT/L/LU	16	10	55m6	49	110	20	42							
LSMV 225 SR/MR/MG	18	11	60m6	53	140	20	42							
LSMV 250 ME	18	11	65m6	58	140	20	42							
LSMV 280 SD/SC/MC/MK	20	12	75m6	67,5	140	20	42							
LSMV 315 SP/MP/MR	22	14	80m6	71	170	20	42							

Type	Secondary shaft end													
	4 and 6 poles							2 poles						
	FA	GF	DA	GB	EA	OA	pA	FA	GF	DA	GB	EA	OA	pA
LSMV 71 L	5	5	14j6	11	30	5	15	5	5	14j6	11	30	5	15
LSMV 80 L	5	5	14j6	11	30	5	15	5	5	14j6	11	30	5	15
LSMV 90 S/L/SL	6	6	19j6	15,5	40	6	16	6	6	19j6	15,5	40	6	16
LSMV 100 L	8	7	24j6	20	50	8	19	8	7	24j6	20	50	8	19
LSMV 112 M/MG	8	7	24j6	20	50	8	19	8	7	24j6	20	50	8	19
LSMV 132 S/SM/M	8	7	28j6	24	60	10	22	8	7	28j6	24	60	10	22
LSMV 160 MR/MP/ML/LU	12	8	42k6	37	110	16	36							
LSMV 180 M/L/LU	14	9	48k6	42,5	110	16	36							
LSMV 200 LT/L/LU	16	10	55m6	49	110	20	42							
LSMV 225 SR/MR/MG	18	11	60m6	53	140	20	42							
LSMV 250 ME	18	11	60m6	53	140	20	42							
LSMV 280 SD/SC/MC/MK	18	11	65m6	58	140	20	42							
LSMV 315 SP/MP/MR	22	14	80m6	71	170	20	42							

Asynchronous LSMV motors for speed variation Dimensions

D2 - Foot mounted IM B3 (IM 1001)

Dimensions in millimetres

Overall dimensions of totally enclosed three-phase LSMV - IP 55 asynchronous motors without options

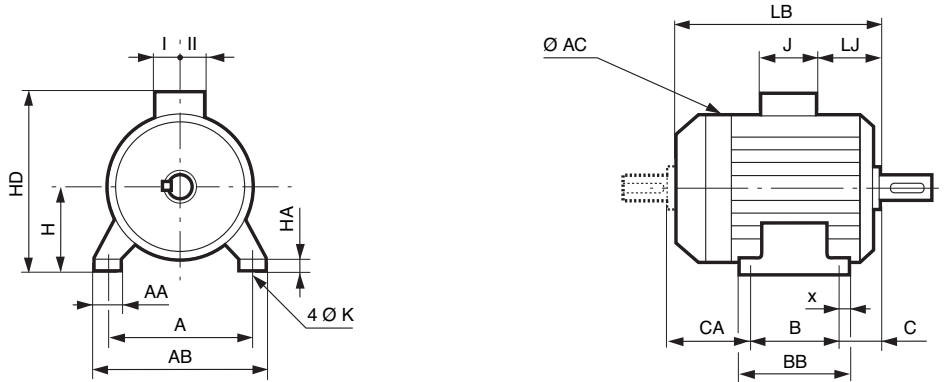

Type	Main Dimensions																	
	A	AB	B	BB	C	x	AA	K	HA	H	AC	HD	LB	LJ	J	I	II	CA
LSMV 71 L	112	126	90	106	45	7,5	24	7	9	71	140	170	193	26	86	43	43	61
LSMV 80 L	125	157	100	120	50	10	29	9	10	80	170	220	215	13,5	160	55	55	68
LSMV 90 L	140	172	125	162	56	28	37	10	11	90	190	240	245	13,5	160	55	55	68
LSMV 90 S	140	172	100	120	56	10	37	10	11	90	190	240	218	13,5	160	55	55	66
LSMV 90 SL	140	172	125	162	56	28	37	10	11	90	190	240	245	13,5	160	55	55	68
LSMV 100 L	160	196	140	165	63	12	40	12	13	100	200	255	290	14	160	55	55	93
LSMV 112 M	190	220	140	165	70	12	45	12	14	112	200	272	290	14,5	160	55	55	86
LSMV 112 MG	190	220	140	165	70	12	52	12	14	112	235	276	315	24	160	55	55	110
LSMV 132 M	216	250	178	211	89	16	50	12	15	132	280	319	387	25	160	55	55	126
LSMV 132 S	216	250	140	170	89	16	50	12	15	132	235	296	350	41	160	55	55	128
LSMV 132 SM	216	250	178	211	89	16	50	12	15	132	280	319	387	25	160	55	55	126
LSMV 160 MP	254	294	210	294	108	20	64	14	25	160	280	368	468	55,5	134	92	63	154
LSMV 160 MR	254	294	210	294	108	20	64	14	25	160	280	368	495	44	134	92	63	182
LSMV 160 M	254	294	210	294	108	20	60	14	25	160	316	395	495	44	134	92	63	182
LSMV 160 L	254	294	254	294	108	20	60	14	25	160	316	395	495	44	134	92	63	138
LSMV 160 LU	254	294	254	294	108	20	60	14	25	160	316	395	510	44	134	92	63	153
LSMV 180 M	279	339	241	291	121	25	86	14,5	25	180	350	435	552	63,5	186	111,5	98	197
LSMV 180 L	279	339	279	329	121	25	86	14,5	25	180	350	435	552	63,5	186	111,5	98	159
LSMV 180 LU	279	339	279	329	121	25	86	14,5	25	180	350	435	593	63,5	186	111,5	98	199
LSMV 200 LT	318	378	305	365	133	30	108	18,5	30	200	350	455	599	69,5	186	111,5	98	167
LSMV 200 L	318	388	305	375	133	35	103	18,5	36	200	390	475	621	77	186	111,5	98	194
LSMV 200 LU	318	388	305	375	133	35	103	18,5	36	200	390	475	669	68	205	100	95	244
LSMV 225 SR	356	431	286	386	149	50	127	18,5	36	225	390	500	676	84	186	111,5	98	253
LSMV 225 MR	356	431	311	386	149	50	127	18,5	36	225	390	500	676	84	186	111,5	98	228
LSMV 225 MG	356	420	311	375	149	30	65	18,5	30	225	479	630	810	68	292	148	180	360
LSMV 250 ME	406	470	349	420	168	35	90	24	36	250	479	655	810	68	292	148	180	303
LSMV 280 SC	457	520	368	478	190	35	90	24	35	280	479	685	810	68	292	148	180	262
LSMV 280 SD	457	520	368	478	190	35	90	24	35	280	479	685	870	68	292	148	180	322
LSMV 280 MC	457	520	419	478	190	35	90	24	35	280	479	685	810	68	292	148	180	211
LSMV 280 MK	457	533	419	495	190	40	85	24	35	280	586	746	921	99	292	148	180	328
LSMV 315 SP	508	594	406	537	216	40	114	28	70	315	586	781	947	125	292	148	180	341
LSMV 315 MP	508	594	457	537	216	40	114	28	70	315	586	781	947	125	292	148	180	290
LSMV 315 MR	508	594	457	537	216	40	114	28	70	315	586	781	1017	125	292	148	180	360



Asynchronous LSMV motors for speed variation Dimensions

D3 - Foot and flange mounted with plain holes IM B35 (IM 2001)

Dimensions in millimetres

Overall dimensions of totally enclosed three-phase LSMV - IP 55 asynchronous motors without options

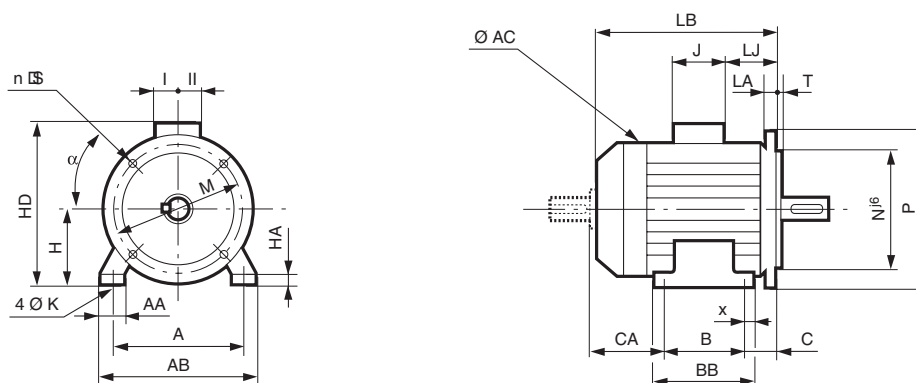

Main Dimensions

Type	A	AB	B	BB	C	x	AA	K	HA	H	AC	HD	LB	LJ	J	I	II	Sym.
LSMV 71 L	112	126	90	106	45	7,5	24	7	9	71	140	170	193	26	86	43	43	FF 130
LSMV 80 L	125	157	100	120	50	10	29	9	10	80	170	220	215	13,5	160	55	55	FF 165
LSMV 90 L	140	172	125	162	56	28	37	10	11	90	190	240	265	33,5	160	55	55	FF 165
LSMV 90 S	140	172	100	120	56	10	37	10	11	90	190	240	238	33,5	160	55	55	FF 165
LSMV 90 SL	140	172	125	162	56	28	37	10	11	90	190	240	265	33,5	160	55	55	FF 165
LSMV 100 L	160	196	140	165	63	12	40	12	13	100	200	255	290	14	160	55	55	FF 215
LSMV 112 M	190	220	140	165	70	12	45	12	14	112	200	267	290	14,5	160	55	55	FF 215
LSMV 112 MG	190	220	140	165	70	12	52	12	14	112	235	276	315	24	160	55	55	FF 215
LSMV 132 M	216	250	178	211	89	16	50	12	15	132	280	319	387	25	160	55	55	FF 265
LSMV 132 S	216	250	140	170	89	16	50	12	15	132	235	296	350	41	160	55	55	FF 265
LSMV 132 SM	216	250	178	211	89	16	50	12	15	132	280	319	387	25	160	55	55	FF 265
LSMV 160 MP	254	294	210	294	108	20	64	14	25	160	280	368	468	55,5	134	92	63	FF 300
LSMV 160 MR	254	294	210	294	108	20	64	14	25	160	280	368	495	44	134	92	63	FF 300
LSMV 160 M	254	294	210	294	108	20	60	14	25	160	316	395	495	44	134	92	63	FF 300
LSMV 160 L	254	294	254	294	108	20	60	14	25	160	316	395	495	44	134	92	63	FF 300
LSMV 160 LU	254	294	254	294	108	20	60	14	25	160	316	395	510	44	134	92	63	FF 300
LSMV 180 M	279	339	241	329	121	25	86	14,5	25	180	350	435	555	63,5	186	111,5	98	FF 300
LSMV 180 L	279	339	279	329	121	25	86	14,5	25	180	350	435	552	63,5	186	111,5	98	FF 300
LSMV 180 LU	279	339	279	329	121	25	86	14,5	25	180	350	435	593	63,5	186	111,5	98	FF 300
LSMV 200 LT	318	378	305	365	133	30	108	18,5	30	200	350	450	599	69,5	186	111,5	98	FF 350
LSMV 200 L	318	388	305	375	133	35	103	18,5	36	200	390	475	621	77	186	111,5	98	FF 350
LSMV 200 LU	318	388	305	375	133	35	103	18,5	36	200	390	475	669	68	205	100	95	FF 350
LSMV 225 SR	356	431	286	386	149	50	127	18,5	36	225	390	500	676	84	186	111,5	98	FF 400
LSMV 225 MR	356	431	311	386	149	50	127	18,5	36	225	390	500	676	84	186	111,5	98	FF 400
LSMV 225 MG	356	420	311	375	149	30	65	18,5	30	225	479	630	810	68	292	148	180	FF 400
LSMV 250 ME	406	470	349	420	168	35	90	24	36	250	479	655	810	68	292	148	180	FF 500
LSMV 280 SC	457	520	368	478	190	35	90	24	35	280	479	685	810	68	292	148	180	FF 500
LSMV 280 SD	457	520	368	478	190	39	90	24	35	280	479	685	870	68	292	148	180	FF 500
LSMV 280 MC	457	520	419	478	190	35	90	24	35	280	479	685	810	68	292	148	180	FF 500
LSMV 280 MK	457	533	419	495	190	40	85	24	35	280	586	746	921	99	292	148	180	FF 500
LSMV 315 SP	508	594	406	537	216	40	114	28	70	315	586	781	951	125	292	148	180	FF 600
LSMV 315 MP	508	594	457	537	216	40	114	28	70	315	586	781	951	125	292	148	180	FF 600
LSMV 315 MR	508	594	457	537	216	40	114	28	70	315	586	781	1021	125	292	148	180	FF 600

Overall CA and shaft end dimensions are identical to the form of foot mounted motors.

Asynchronous LSMV motors for speed variation Dimensions

D4 - Flange mounted with plain holes IM B5 (IM 3001)

Dimensions in millimetres

Overall dimensions of totally enclosed three-phase LSMV - IP 55 asynchronous motors without options

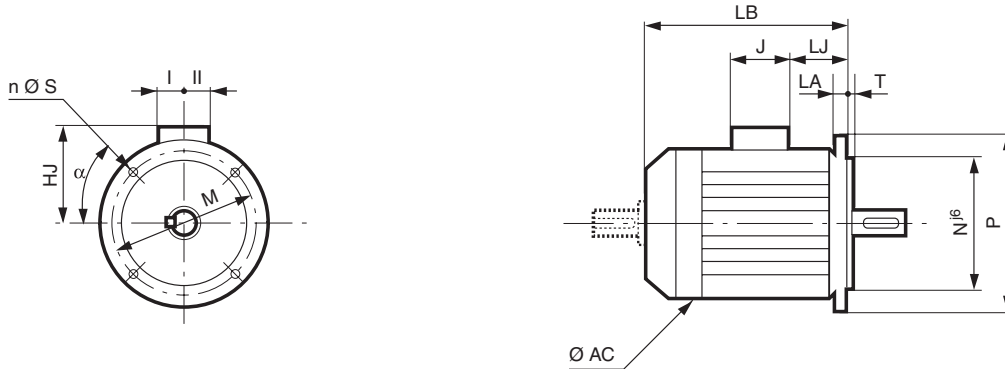

IEC symbol	Overall flange dimensions							
	M	N	P	T	n	α	S	LA
FF 130	130	110	160	3,5	4	45	10	10
FF 165	165	130	200	3,5	4	45	12	10
FF 165	165	130	200	3,5	4	45	12	10
FF 165	165	130	200	3,5	4	45	12	10
FF 215	215	180	250	4	4	45	14,5	12
FF 215	215	180	250	4	4	45	14,5	12
FF 215	215	180	250	4	4	45	14,5	12
FF 265	265	230	300	4	4	45	14,5	14
FF 265	265	230	300	4	4	45	14,5	14
FF 265	265	230	300	4	4	45	14,5	14
FF 300	300	250	350	5	4	45	18,5	14
FF 300	300	250	350	5	4	45	18,5	14
FF 300	300	250	350	5	4	45	18,5	14
FF 300	300	250	350	5	4	45	18,5	14
FF 300	300	250	350	5	4	45	18,5	14
FF 300	300	250	350	5	4	45	18,5	14
FF 300	300	250	350	5	4	45	18,5	14
FF 350	350	300	400	5	4	45	18,5	15
FF 350	350	300	400	5	4	45	18,5	15
FF 350	350	300	400	5	4	45	18,5	15
FF 400	400	350	450	5	8	22,5	18,5	16
FF 400	400	350	450	5	8	22,5	18,5	16
FF 400	400	350	450	5	8	22,5	18,5	16
FF 500	500	450	550	5	8	22,5	18,5	18
FF 500	500	450	550	5	8	22,5	18,5	18
FF 500	500	450	550	5	8	22,5	18,5	18
FF 500	500	450	550	5	8	22,5	18,5	18
FF 500	500	450	550	5	8	22,5	18,5	18
FF 600	600	550	660	6	8	22,5	24	22
FF 600	600	550	660	6	8	22,5	24	22
FF 600	600	550	660	6	8	22,5	24	22

Type	Main dimensions						
	AC	LB	HJ	LJ	J	I	II
LSMV 71 L	140	193	99	26	86	43	43
LSMV 80 L	170	215	145	13,5	160	55	55
LSMV 90 L	190	265	150	33,5	160	55	55
LSMV 90 S	190	238	150	33,5	160	55	55
LSMV 90 SL	190	265	150	33,5	160	55	55
LSMV 100 L	200	290	160	14	160	55	55
LSMV 112 M	200	290	160	14,5	160	55	55
LSMV 112 MG	235	315	169	24	160	55	55
LSMV 132 M	280	387	182	25	160	55	55
LSMV 132 S	235	350	182	41	160	55	55
LSMV 132 SM	280	387	182	25	160	55	55
LSMV 160 MP	280	468	198	55,5	134	92	63
LSMV 160 MR	280	495	198	44	134	92	63
LSMV 160 M	316	495	235	44	134	92	63
LSMV 160 L	316	495	235	44	134	92	63
LSMV 160 LU	316	510	235	44	134	92	63
LSMV 180 M	350	555	255	63,5	186	111,5	98
LSMV 180 L	350	552	255	63,5	186	111,5	98
LSMV 180 LU	350	593	255	63,5	186	111,5	98
LSMV 200 LT	350	599	250	69,5	186	111,5	98
LSMV 200 L	390	621	275	77	186	111,5	98
LSMV 200 LU	390	669	275	68	205	100	95
LSMV 225 SR	390	676	275	84	186	111,5	98
LSMV 225 MR	390	676	275	84	186	111,5	98
LSMV 225 MG	479	810	405	68	292	148	180
LSMV 250 ME	479	810	405	68	292	148	180
LSMV 280 SC	479	810	405	68	292	148	180
LSMV 280 SD	479	870	405	68	292	148	180
LSMV 280 MC	479	810	405	68	292	148	180
LSMV 280 MK	586	921	466	99	292	148	180
LSMV 315 SP	586	951	466	125	292	148	180
LSMV 315 MP	586	951	466	125	292	148	180
LSMV 315 MR	586	1021	466	125	292	148	180

The form of the motors IM 3001 (IM B5) stop at frame size 225.
Overall shaft end dimensions are identical to the form of foot mounted motors.

Asynchronous LSMV motors for speed variation Dimensions

D5 - Foot and flange mounted with tapped holes IM B34 (IM 2101)

Overall dimensions of totally enclosed three-phase LSMV - IP 55 asynchronous motors without options

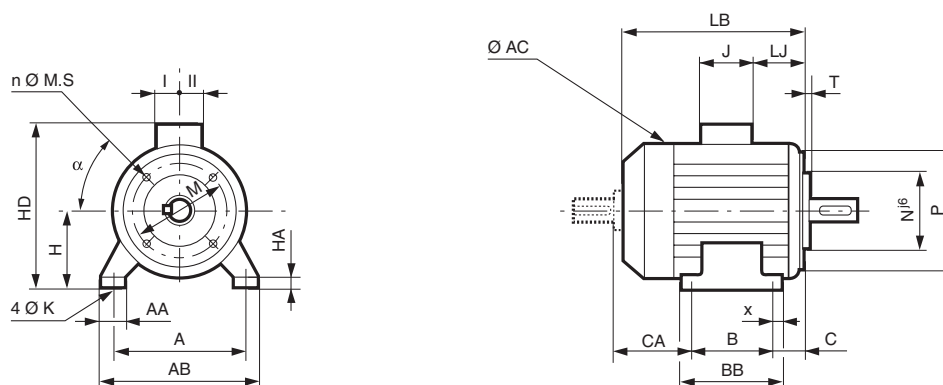

Main Dimensions

Type	A	AB	B	BB	C	x	AA	K	HA	H	AC	HD	LB	LJ	J	I	II	Sym.
LSMV 71 L	112	126	90	106	45	7,5	24	7	9	71	140	170	193	26	86	43	43	FT 85
LSMV 80 L	125	157	100	120	50	10	29	9	10	80	170	220	215	13,5	160	55	55	FT 100
LSMV 90 L	140	172	125	162	56	28	37	10	11	90	190	240	245	13,5	160	55	55	FT 115
LSMV 90 S	140	172	100	120	56	10	37	10	11	90	190	240	218	13,5	160	55	55	FT 115
LSMV 90 SL	140	172	125	162	56	28	37	10	11	90	190	240	245	13,5	160	55	55	FT 115
LSMV 100 L	160	196	140	165	63	12	40	12	13	100	200	255	290	14	160	55	55	FT 130
LSMV 112 M	190	220	140	165	70	12	45	12	14	112	200	267	290	14,5	160	55	55	FT 130
LSMV 112 MG	190	220	140	165	70	12	52	12	14	112	235	276	315	24	160	55	55	FT 130
LSMV 132 M	216	250	178	208	89	16	59	12	18	132	280	314	387	25	160	55	55	FT 215
LSMV 132 S	216	250	140	170	89	16	50	12	15	132	235	296	350	41	160	55	55	FT 215
LSMV 132 SM	216	250	178	208	89	16	59	12	18	132	280	314	387	25	160	55	55	FT 215
LSMV 160 MP	254	294	210	294	108	20	64	15	25	160	280	368	468	55,5	160	55	55	FT 265
LSMV 160 MR	254	294	210	250	108	20	112	14	25	160	280	368	495	44	134	92	63	FT 265

Overall CA and shaft end dimensions are identical to the form of foot mounted motors.

Asynchronous LSMV motors for speed variation Dimensions

D6 - Foot and flange mounted with tapped holes IM B14 (IM 3601)

Overall dimensions of totally enclosed three-phase LSMV - IP 55 asynchronous motors without options

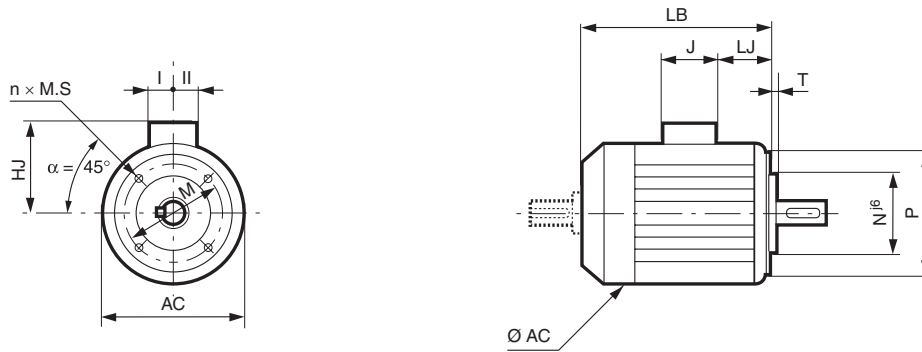

IEC symbol	Overall flange dimensions					
	M	N	P	T	n	MS
FT 85	85	70	105	2.5	4	M6
FT 100	100	80	120	3	4	M6
FT 115	115	95	140	3	4	M8
FT 115	115	95	140	3	4	M8
FT 115	115	95	140	3	4	M8
FT 130	130	110	160	3.5	4	M8
FT 130	130	110	160	3.5	4	M8
FT 130	130	110	160	3.5	4	M8
FT 215	215	180	250	4	4	M12
FT 215	215	180	250	4	4	M12
FT 215	215	180	250	4	4	M12
FT 265	265	230	300	4	4	M12
FT 265	265	230	300	4	4	M12

Type	Main dimensions						
	AC	LB	HJ	LJ	J	I	II
LSMV 71 L	140	193	99	26	86	43	43
LSMV 80 L	170	215	140	13,5	160	55	55
LSMV 90 L	190	245	150	13,5	160	55	55
LSMV 90 S	190	218	150	13,5	160	55	55
LSMV 90 SL	190	245	150	13,5	160	55	55
LSMV 100 L	200	290	155	14	160	55	55
LSMV 112 M	200	290	155	14,5	160	55	55
LSMV 112 MG	235	310	169	24	160	55	55
LSMV 132 M	280	387	182	25	160	55	55
LSMV 132 S	235	350	164	41	160	55	55
LSMV 132 SM	280	387	182	25	160	55	55
LSMV 160 MP	280	468	208	55,5	160	55	55
LSMV 160 MR	280	495	208	44	134	92	63

Overall shaft end dimensions are identical to the form of foot mounted motors.

Asynchronous LSMV motors for speed variation Dimensions

D7 - Overall dimensions of options

D7.1 - LSMV MOTORS WITH OPTIONS

The integration of LSMV motors within a process, sometimes needs accessories that will facilitate operating:

- forced ventilation for motors operating at low or high speed

- parking brakes to hold the motor in the stop position without having to maintain power on the motor
- emergency stop brakes to immobilize a load in case of a failure in the control of the motor torque or a rupture in the supply network.
- an encoder which gives digital information

enabling a more precise control of speed and positioning.

All of these options can be combined as indicated in the table below.

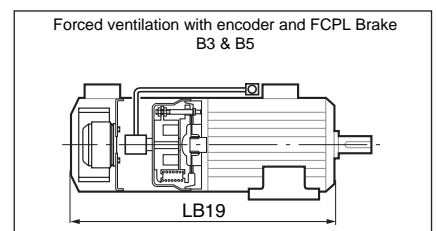
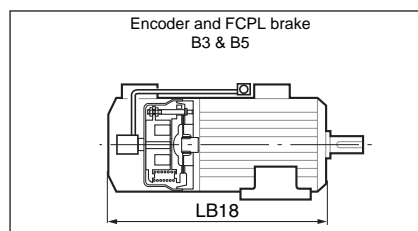
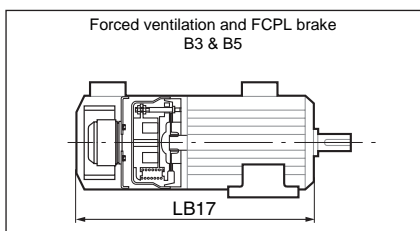
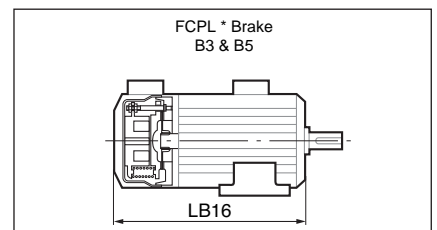
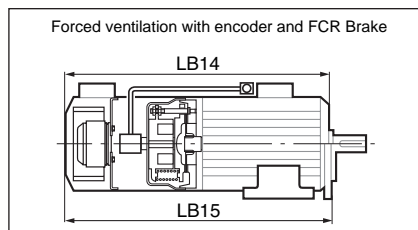
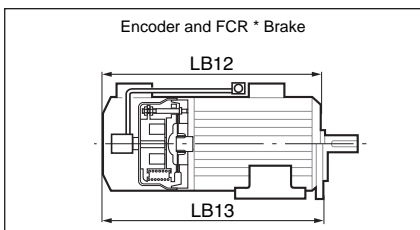
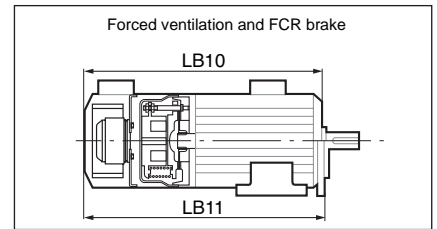
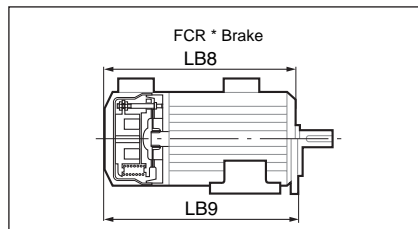
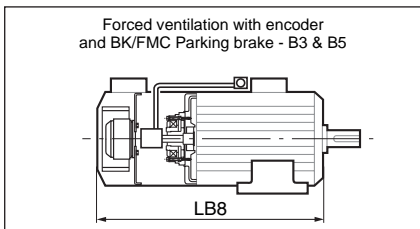
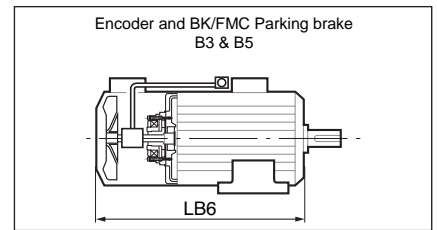
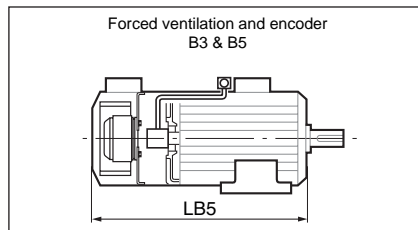
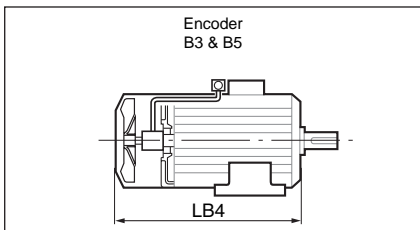
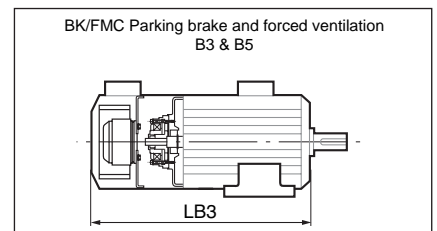
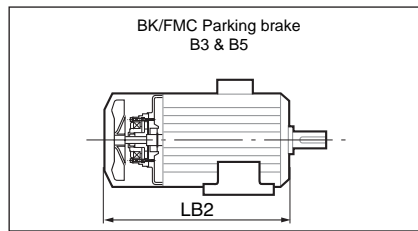
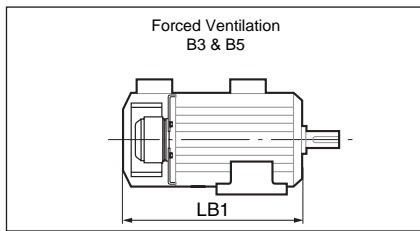

*These options are self ventilated.

Asynchronous LSMV motors for speed variation Dimensions

D7 - Overall dimensions of options

Type	LB ₁	LB ₂	LB ₃	LB ₄	LB ₅	LB ₆	LB ₇	LB ₈	LB ₉	LB ₁₀	LB ₁₁	LB ₁₂	LB ₁₃	LB ₁₄	LB ₁₅	LB ₁₆	LB ₁₇	LB ₁₈	LB ₁₉
LSMV 71 L	277	240	277	270	277	300	333	245	271	378	404	298	324	378	404	-	-	-	-
LSMV 80 L	315	251	340	295	351	359	415	265	292	447	474	357	384	447	474	-	-	-	-
LSMV 90 S	311	276	335	CU	CU	CU	CU	-	-	-	-	-	-	-	-	-	-	-	-
LSMV 90 SL	338	302	362	328	383	375	430	-	-	-	-	-	-	-	-	-	-	-	-
LSMV 90 L	338	302	362	328	383	375	430	304	324	392	412	374	394	466	486	-	-	-	-
LSMV 100 L	380	354	395	376	431	440	495	388	388	440	476	422	458	514	550	-	-	-	-
LSMV 112 M	380	354	395	376	431	440	495	-	-	-	-	-	-	-	-	-	-	-	-
LSMV 112 MG	429	380	455	396	443	459	497	396	425	552	581	457	499	552	581	-	-	-	-
LSMV 132 S	425	400	445	CU	CU	CU	CU	-	-	-	-	-	-	-	-	-	-	-	-
LSMV 132 SM	462	447	482	461	499	535	573	493	533	673	713	563	603	673	713	-	-	-	-
LSMV 132 M	462	447	482	461	499	535	573	493	533	673	713	563	603	673	713	-	-	-	-
LSMV 160 MR	CU	CU	CU	CU	CU	CU	CU	568	568	748	748	638	638	748	748	-	-	-	-
LSMV 160 MP	710	CU	CU	CU	710	CU	CU	-	-	-	-	-	-	-	-	603	CU	673	CU
LSMV 160 M	687	-	-	549	687	-	-	-	-	-	-	-	-	-	-	668	CU	748	CU
LSMV 160 L	687	-	-	549	687	-	-	-	-	-	-	-	-	-	-	668	CU	748	CU
LSMV 160 LU	702	-	-	564	702	-	-	-	-	-	-	-	-	-	-	683	CU	763	CU
LSMV 180 M	741	-	-	602	741	-	-	-	-	-	-	-	-	-	-	795	CU	875	CU
LSMV 180 L	847	723	847	-	-	-	-	-	-	-	-	-	-	-	-	-	-	-	-
LSMV 180 LU	769	-	-	629	769	-	-	-	-	-	-	-	-	-	-	779	CU	859	CU
LSMV 200 LT	775	-	-	635	775	-	-	-	-	-	-	-	-	-	-	828	CU	908	CU
LSMV 200 L	802	-	-	674	802	-	-	-	-	-	-	-	-	-	-	905	CU	985	CU
LSMV 200 LU	847	723	847	-	-	-	-	-	-	-	-	-	-	-	-	-	-	-	-
LSMV 225 SR	854	-	-	730	854	-	-	-	-	-	-	-	-	-	-	953	CU	1035	CU
LSMV 225 MR	854	-	-	730	854	-	-	-	-	-	-	-	-	-	-	953	CU	1033	CU
LSMV 225 MG	1012	-	-	860	1012	-	-	-	-	-	-	-	-	-	-	1120	CU	1180	CU
LSMV 250 ME	1012	-	-	860	1012	-	-	-	-	-	-	-	-	-	-	1180	CU	1180	CU
LSMV 280 SC	1012	-	-	860	1012	-	-	-	-	-	-	-	-	-	-	1246	CU	1246	CU
LSMV 280 SD	1072	-	-	920	1072	-	-	-	-	-	-	-	-	-	-	1246	CU	1246	CU
LSMV 280 MC	1012	-	-	860	1012	-	-	-	-	-	-	-	-	-	-	-	-	-	-
LSMV 280 MK	1075	-	-	965	1075	-	-	-	-	-	-	-	-	-	-	1310	CU	1310	CU
LSMV 315 SP	1137	-	-	991	1137	-	-	-	-	-	-	-	-	-	-	-	-	-	-
LSMV 315 MP	1137	-	-	991	1137	-	-	-	-	-	-	-	-	-	-	-	-	-	-
LSMV 315 MR	1251	-	-	1061	1251	-	-	-	-	-	-	-	-	-	-	-	-	-	-

- : not possible
CU : consult us

Asynchronous LSMV motors for speed variation Construction

PAGES

E1 - Definition of the protection indices (IP/IK) 46

E2 - Component parts 47

E3 - Paint 48

E4 - Construction forms and operating positions 49

E5 - Bearings and greasing 50

E6 - Connections 51

E7 - Machine vibration levels 52-53



Asynchronous LSMV motors for speed variation Construction

E1 - Definition of the protection indices (IP/IK)

The LSMV motors are in standard IP 55/IK 08 configuration

Protection indices for electrical material

According to IEC 60034-5 - EN 60034-5 (IP) - EN 50102 (IK) standards

1st number: protection against solid bodies			2nd number: protection against liquid			3rd number: mechanical protection		
IP	Tests	Definition	IP	Tests	Definition	IK	Tests	Definition
0		No protection	0		No protection	00		No protection
1	$\varnothing 50 \text{ mm}$	Protected against solid bodies superior to 50 mm (example: involuntary hand contacts)	1		Protected against vertical water drops (condensation)	01		Impact energy: 0,15 J
2	$\varnothing 12 \text{ mm}$	Protected against solid bodies superior to 12 mm (example: fingers)	2		Protected against vertical water drops within a range of 15°	02		Impact energy: 0,20 J
3	$\varnothing 2.5 \text{ mm}$	Protected against solid bodies superior to 2,5 mm (examples: tools, wire)	3		Protected against vertical water drops within a range of 60°	03		Impact energy: 0,37 J
4	$\varnothing 1 \text{ mm}$	Protected against solid bodies superior to 1 mm (examples: thin tools, small wire)	4		Protected against water drops from all directions	04		Impact energy: 0,50 J
5		Protected against dust (no harmful deposit)	5		Protected against water jets from all directions	05		Impact energy: 0,70 J
6		Protected against any dust penetration.	6		Protected against water projections comparable to green sea	06		Impact energy: 1 J
			7		Protected against submersion effects from 0,15 to 1 m	07		Impact energy: 2 J
			8		Protected against extended submersion effects under pressure	08		Impact energy: 5 J
						09		Impact energy: 10 J
						10		Impact energy: 20 J

Example:

IP 55 Machine case

IP : Protection index.

5 : Machine protected against dust and accidental contacts.

Test criteria: no ingress of harmful amounts of dust, no direct contact with rotating parts. Duration of test 2 hours (test criteria: no ingress of talc harmful to the good operation of the machine).

5 : Machine protected against water projections in all directions from a water jet with a flow of 12,5 l/min under 0,3 bars at a distance of 3 m from the machine.

Duration of test 3 minutes (test criteria: no harmful ingress of water projected onto the machine).

Asynchronous LSMV motors for speed variation Construction

E2 - Component parts

LSMV Motor description

Designations	Materials	Remarks
1 Finned housing	Aluminium alloy	<ul style="list-style-type: none"> - with cast or bolt on feet, or without feet - pressure die cast for shaft height ≤ 180 - gravity die cast for shaft height ≥ 200 <ul style="list-style-type: none"> • 4 or 6 mounting holes for foot housing • motor lifting rings for shaft height ≥ 160, option in 132 and 112 - earth terminal in housing optional
2 Stator	Insulated low carbon magnetic steel laminations Electrolytic copper	<ul style="list-style-type: none"> - the low carbon content guarantees long term stability of the characteristics - sheet steel lamination assembly - optimised magnetic circuit. - impregnation allowing resistance to violent voltage variations generated by high switching frequencies of the IGBT transistor drives in accordance to IEC 34-17 standard - class F insulation system - thermal protection assured by PTC probes (1 per phase, 2-wire output)
3 Rotor	Insulated low carbon magnetic steel laminations Aluminium (A5L)	<ul style="list-style-type: none"> - Inclined slots - squirrel cage pressure die cast in aluminium (or alloy for special applications) - mounted on the shaft by shrink fitting and keyed for lifting applications - dynamically balanced rotor level A or B
4 Shaft	Steel	
5 End shields	Aluminium Cast iron	<ul style="list-style-type: none"> - shaft height 71 (cast iron end shield) - shaft height 80 to 315
6 Bearings and greasing		<ul style="list-style-type: none"> - ball bearings C3 type - pre-loaded rear bearings - protected types greased for life up to and including 180 height - semi-protected or open from 200 shaft height - open types re-greasable from 225 shaft height
7 Labyrinth seal Lip seals	Technopolymer or steel Synthetic rubber	<ul style="list-style-type: none"> - front lipseals or deflector for all flange motors - lipseals, deflector or labyrinth seals for foot mounted motors
8 Fan	Composite material	- 2 directions of rotation: straight blades
9 Fan cover	Steel sheet	- equipped on request with a rain drip cover for vertical operation, shaft end facing downwards.
10 Terminal box	Aluminium alloy	<ul style="list-style-type: none"> - equipped with an 8 steel stud terminal block (brass option) - terminal box delivered fitted with a cable gland - 1 earth terminal in all terminal boxes

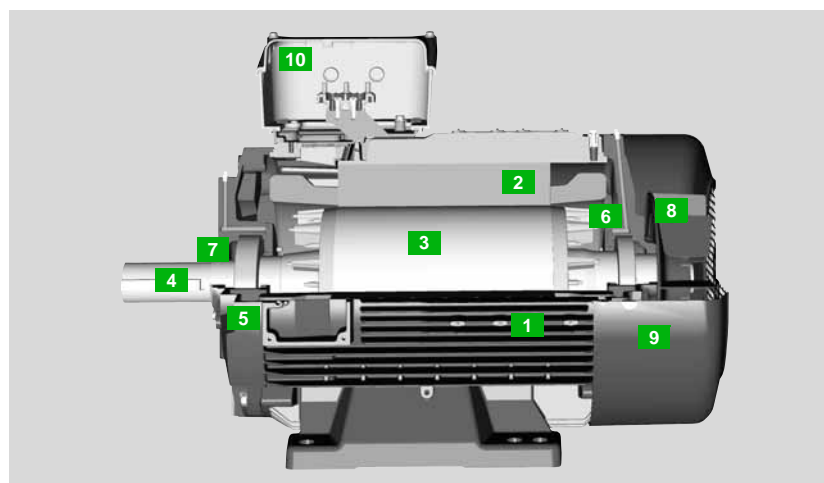

Asynchronous LSMV motors for speed variation Construction

E3 - External finish

*LSMV motors conform
to the System Ia prescription*

LEROY-SOMER motors are protected with a range of surface finishes.
The surfaces receive appropriate special treatments, as listed below.

Surface preparation

SURFACE	PARTS	TREATMENT
Cast iron	End Shields	Shot blasting + Primer
Steel	Accessories	Phosphatization + Primer
	Fan Covers	Electrostatic or Epoxy powder
Aluminium alloy	Housing - Terminal boxes	Shot blasting

Definition of atmospheres

An atmosphere is considered as corrosive when components are attacked by oxygen.
It is said to be aggressive when components are attacked by bases of acids or salts.

Painting systems

PRODUCTS	ATMOSPHERE	SYSTEM	APPLICATIONS	RESISTANCE TO SALINE MIST ISO 9227 standard
LEROY-SOMER Motors	Little or non aggressive (indoors, rural, industrial)	Ia	1 coat polyurethane finish 20/30 µm	72 hours
	Moderately corrosive: humid, and outside (temperate climate)	IIa	1 base coat Epoxy 30/40 µm 1 coat polyurethane finish 20/30 µm	150 hours
	Corrosive: coastal, very humid (tropical climate)	IIIa	1 base coat Epoxy 30/40 µm 1 intermediate coat Epoxy 30/40 µm 1 coat polyurethane finish 20/30 µm	300 hours
	Significant level of chemical attack: frequent contact with bases, acids, alkalines environment - neutral atmosphere (not on contact with chlorinated or sulphurous products)	IIIb	1 base coat Epoxy 30/40 µm 1 intermediate coat Epoxy 30/40 µm 1 coat finish Epoxy 25/35 µm	500 hours

The Ia system is for moderate climates and the IIa system is for general climates as defined by the IEC 60721-2-1 standard.
Exposure to saline mist under the terms of the ISO 9227 standard.

Paint reference (black):

RAL 9005

Asynchronous LSMV motors for speed variation Construction

E4 - Construction forms and operating positions

Mounting methods and positions (according to the IEC 60034-7 standard)

Foot mounted motors

- all shaft heights

IM 1001 (IM B3)
- Horizontal shaft
- Floor mounted

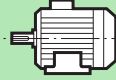

IM 1071 (IM B8)
- Horizontal shaft
- Ceiling mounted

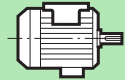

IM 1051 (IM B6)
- Horizontal shaft
- Wall mounted on left as
viewed from shaft end

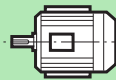

IM 1011 (IM V5)
- Vertical shaft downwards
- Wall mounted



IM 1061 (IM B7)
- Horizontal shaft
- Wall mounted on right as
viewed from shaft end

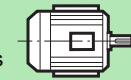

IM 1031 (IM V6)
- Shaft vertical upwards
- Wall mounted

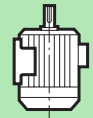

Flange mounted motor (FF) with plain holes

- all shaft heights
(except IM 3001 limited to 225 shaft height)

IM 3001 (IM B5)
- Horizontal shaft

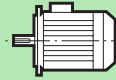

IM 2001 (IM B35)
- Horizontal shaft
- Floor mounted

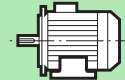

IM 3011 (IM V1)
- Vertical shaft downwards

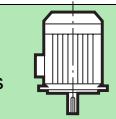

IM 2011 (IM V15)
- Vertical shaft downwards
- Wall mounted



IM 3031 (IM V3)
- Vertical shaft upwards

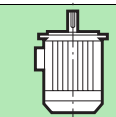

IM 2031 (IM V36)
- Vertical shaft on top
- Wall mounted

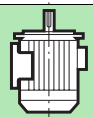

Flange mounted motor (FT) with tapped holes

- all shaft heights ≤ 132 mm

IM 3601 (IM B14)
- Horizontal shaft

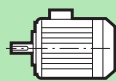

IM 2101 (IM B34)
- Horizontal shaft
- Floor mounted

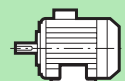

IM 3611 (IM V18)
- Vertical shaft to the bottom



IM 2111 (IM V58)
- Vertical shaft on the bottom
- Wall mounted



IM 3631 (IM V19)
- Vertical shaft to the top

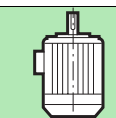

IM 2131 (IM V69)
- Vertical shaft on top
- Wall mounted



Motors without front bearing

Caution: the (IP) protection plated on name plate of the IMB9 and IM B15 motors must be assured during the mounting of the motor by the customer

IM 9101 (IM B9)
- Spigot and tie rods
- Horizontal shaft

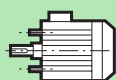

IM 1201 (IM B15)
- Foot and spigot with tie
- Horizontal shaft

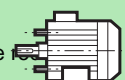

Asynchronous LSMV motors for speed variation Construction

E5 - Bearings and greasing

E5.1 - GREASED FOR LIFE BEARINGS

For motors with shaft heights from 71 to 132, the type and size of the bearings enable long life-time and therefore greasing for life for the machines.

E5.2 - BEARINGS WITH GREASE NIPPLES

Motors 160 and 180 with greased for life bearings and motor shaft height 200 with factory greased bearings using a lithium soap complex that has an operating range of -20°C and + 150°C, are not fitted with grease nipples.

Under normal operating conditions, the lubricant life span (L10h) in hours is indicated in the chart for machines with horizontal shafts operating at 50 Hz and 60 Hz and in temperatures less than or equal to 25°C.

Speed \ Shaft height	3 600	3 000	1 800	1 500
160	≥ 40 000	≥ 40 000	≥ 40 000	≥ 40 000
180	≥ 40 000	≥ 40 000	≥ 40 000	≥ 40 000
200	16 000	24 000	32 000	≥ 40 000

Note: On request, motors with shaft heights 90 to 200 can be fitted with grease nipples, and 225 and 250 shaft height motors can be supplied without grease nipples.

E5.3 - BEARINGS WITH GREASE NIPPLES

For a standard bearing assembly in a motor shaft height ≥ 160 fitted with grease nipples, the chart on the right, depending on the type of motor, shows the re-greasing intervals to be used at 25°C for horizontal shaft machines.

The chart opposite is valid for LSMV motors lubricated with ESSO UNIREX N3 grease, which is used as standard.

E5.4 - SPECIAL CONSTRUCTION AND AMBIENTS

For vertical shaft machines operating at 25°C, the re-greasing intervals will be approximately 80% of those shown on the chart.

Motors operating at 40°C need more frequent lubrication, the re-greasing intervals will be approximately 50% of those shown on the chart.

Note: the quality and quantity of grease and the re-greasing intervals are shown on the machine's identification plate.

For special assemblies (motors fitted with front roller bearings or other assemblies), machinery with a ≥ 160 shaft height have bearings with grease nipples. Bearing maintenance instructions are given on the identification plates.

Re-greasing intervals according to shaft height and speed of rotation (for standard bearing assemblies).

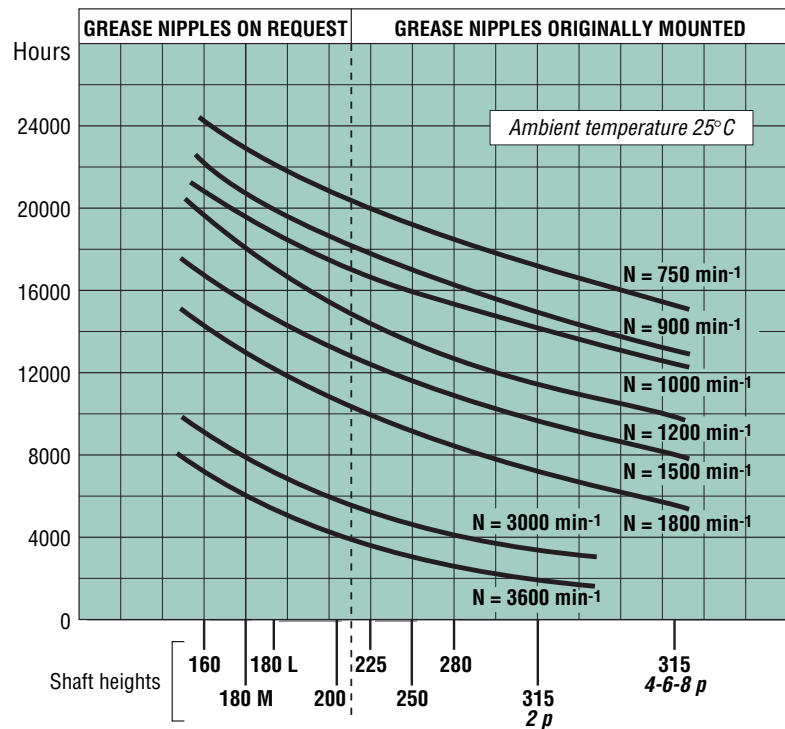

Asynchronous LSMV motors for speed variation Construction

E6 - Connection

E6.1 - TERMINAL BOX

Positioned as standard on the top and front of the motor, IP 55 protected, equipped with cable glands according to the chart below.

The standard position of the cable gland is on the right, as viewed from the end of the motor shaft.

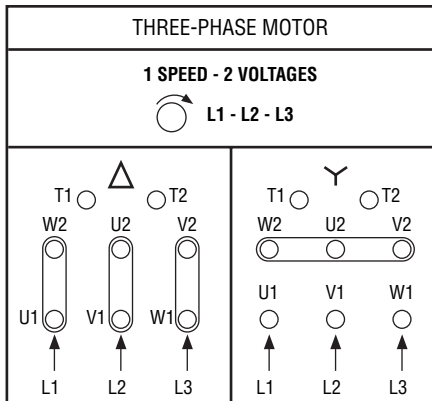

Terminals T1 - T2: Thermal protector connection



Positions of the terminal box relative to the motor shaft end

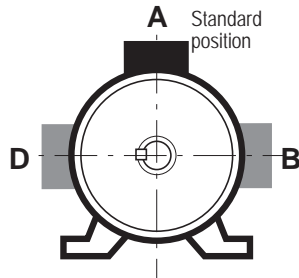

Positions of the cable gland relative to the motor shaft end

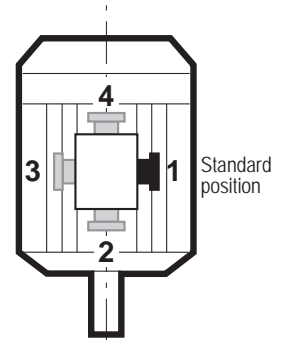

Only positions 1 and 3 are possible

Terminal box position	A	B	D
71 to 132	●	○	○
160 to 315	●	○	○

● : standard

○ : option at extra cost

Cable gland position	1	2	3	4
Foot mounted motor				
71 to 315	●	&	●	&
Flange mounted motor FT				
71 to 315	●	&	●	&
Flange mounted motor FF				
71 to 315	●	&	●	&

● : standard

● : obtainable by simply changing the position of the terminal box or the cable gland

& : not possible in encoder version

E6.2 - THE TERMINAL BLOCKS DIRECTION OF ROTATION

Standard motors are equipped with an 8 terminal block (6 power terminals + 2 terminals for thermal protection).

When the motor is supplied with U1, V1, W1 or 1U, 1V, 1W through a L1, L2, L3 direct supply, it rotates clockwise when viewed from the shaft end.

If the supply is switched on 2 phases, the direction of rotation will be reversed, (it is necessary to check that the motor and machinery can rotate in both directions).

Tightening torque on the terminal block nuts

Terminal	M 4	M 5	M 6	M 8	M 10	M 12	M 16
Torque N. m	2	3.2	5	10	20	35	65

Motor type	230/400 V	
	Number of poles	Terminals
LSMV 71	2 - 4	M4
LSMV 80 to 132 S	2 - 4 - 6 - 8	M5
LSMV 132 M	2 - 4 - 6 - 8	M6
LSMV 160	4 - 6	M6
LSMV 180	4	M8
LSMV 180	6	M6
LSMV 200	4 - 6	M8
LSMV 225	4	M10
LSMV 225	6	M8
LSMV 250	4	M12
LSMV 250	6	M10
LSMV 280 SC	4	M12
LSMV 280 MK	4	M16
LSMV 280 SD	6	M10
LSMV 280 MC	6	M12
LSMV 315 SP	4	M16
LSMV 315 MP/MR	6	M12

Asynchronous LSMV motors for speed variation Construction

E7 - Machine vibration level

E7.1 - LEVEL OF MACHINE VIBRATION - BALANCING

Disymmetries due to construction (magnetic, mechanical and airflow) lead to sinusoidal (or pseudo sinusoidal) vibrations over a wide range of frequencies. Other sources of vibration can also affect motor operation: such as poor mounting, incorrect drive coupling, end shield misalignment, etc.

We shall first of all look at the vibrations emitted at the operating frequency, corresponding to an unbalanced load whose amplitude swamps all other frequencies and on which the dynamic balancing of the mass in rotation has a decisive effect.

Under the ISO 8821 standard, rotating machines can be balanced with or without a key or half-key on the shaft extension. The ISO 8821 standard requires the balancing method to be indicated on the shaft extension as follows:

- half-key balancing: letter H
- full key balancing: letter F
- balancing with key: letter N.

Measured size

The vibration speed can be chosen as the variable to be measured. This is the speed at which the machinery revolves around its rest position. It is measured in mm/s.

As the vibratory movements are complex and non-harmonic, it is the quadratic average (rms value) of the vibration speed which is used to express the vibration level.

Other variables that can also be measured are the vibratory displacement amplitude (in μm) or vibratory acceleration (in m/s^2).

If the vibratory displacement is measured against frequency, the measured value decreases with the frequency: High frequency vibrations are not taken into account.

If the vibratory acceleration is measured, the measured value increases with the frequency: low-frequency vibrations (unbalanced loads) cannot be measured.

LSMV machines have:
- level B for ranges $\leq 132 \text{ mm}$
- level A for ranges $\geq 160 \text{ mm}^*$

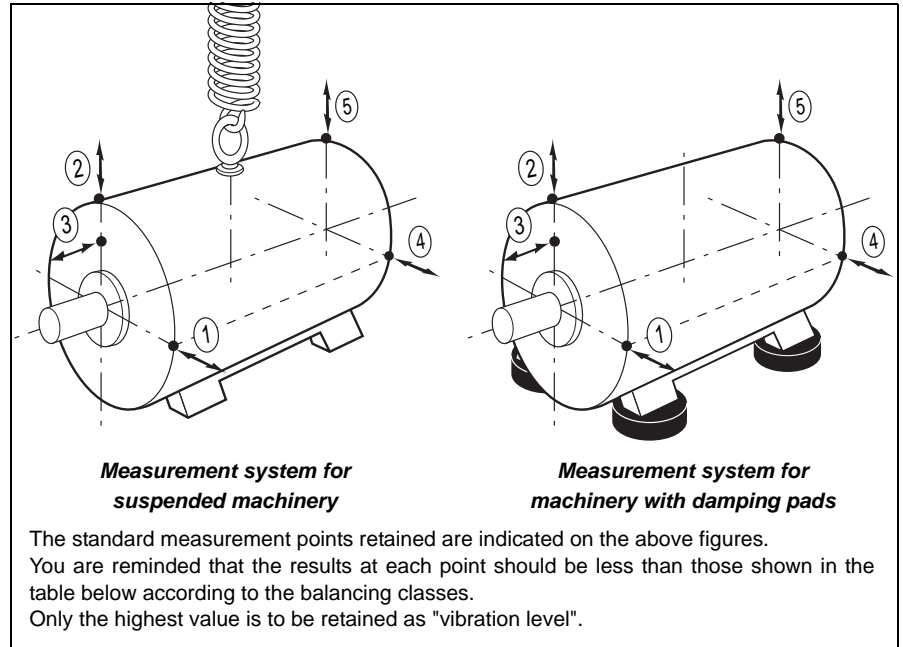

* Ranges 160 LR, 160MP and MR are balancing level B

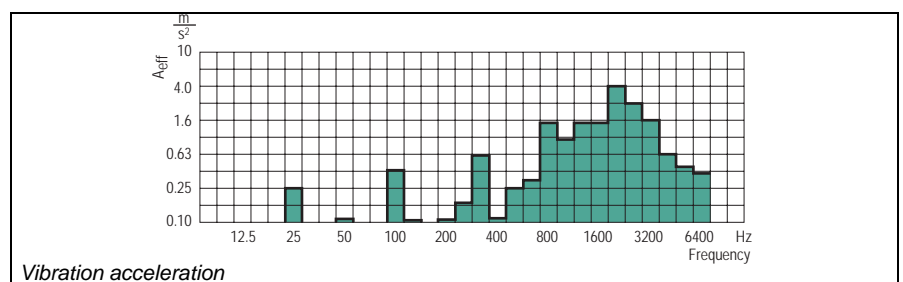
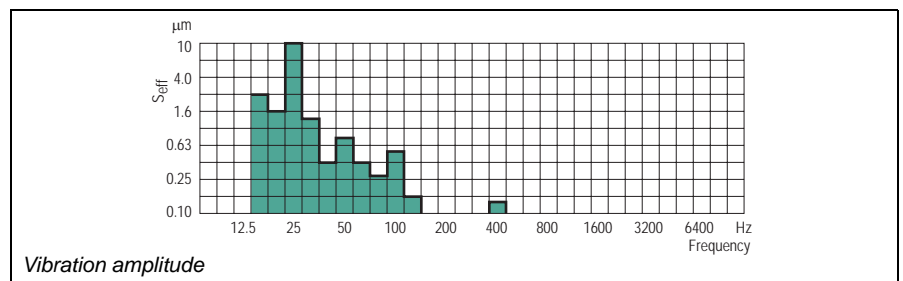
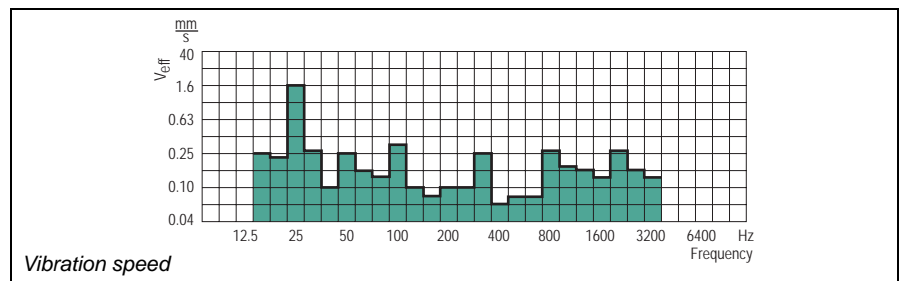

Asynchronous LSMV motors for speed variation Construction

E7 - Machine vibration level

E7.2 - MAXIMUM VIBRATION MAGNITUDE LIMITS, FOR DISPLACEMENT, SPEED AND ACCELERATION IN RMS VALUES FOR FRAME SIZE H (IEC 60034-14)

Vibration level	Frame size H (mm)								
	56 < H ≤ 132			132 < H ≤ 280			H > 280		
	Displacement μm	Speed mm/s	Acceleration m/s ²	Displacement μm	Speed mm/s	Acceleration m/s ²	Displacement μm	Speed mm/s	Acceleration m/s ²
A	25	1.6	2.5	35	2.2	3.5	45	2.8	4.4
B	11	0.7	1.1	18	1.1	1.7	29	1.8	2.8

For large machines and those requiring special levels of vibration, balancing in situ (after assembly) can be accomplished.

In this case, an agreement must be established because the dimensions of the machine may be modified by the necessary addition of balancing discs mounted on the shaft ends.

E7.3 - MECHANICAL SPEED LIMITS FOR VARIABLE SPEED MOTORS

With growing frequency bands, the frequency inverters may, in theory, control a motor 2 or 3 times its rated speed. However, the chosen bearings and balancing class selected for the rotor do not enable

exceeding a maximum mechanical speed without endangering the motor and its life span.

The chart below indicates the maximum speeds supported by the LSMV motors under horizontal and vertical operation.

These speed limit values are given for motors directly connected to the driven machinery (without radial or axial loads).

The relationship enabling to calculate the greasing interval l'g to the frequency is in average:

$$l'g = \frac{25lg}{f}$$

l'g = greasing interval

Maximum mechanical speed for LSMV motors 2, 4 and 6 P

Type	71	80	90	100	112	132	160	160 LU	180	200	225 ST/MT/MR	225 MG	250	280 SC/ML/MD	280 MK	315
Speeds	15000	15000	12000	10000	10000	7500	6000	6000	5600	4500	4300	4000	4000	3400	3200	2700

Any motors required to operate at more than 4000 min⁻¹ are subject to a specific study.

In the case of brake motors, refer to the brake selection chart for speed limits.

For encoder options, high-speed operation can lead to signal saturation.

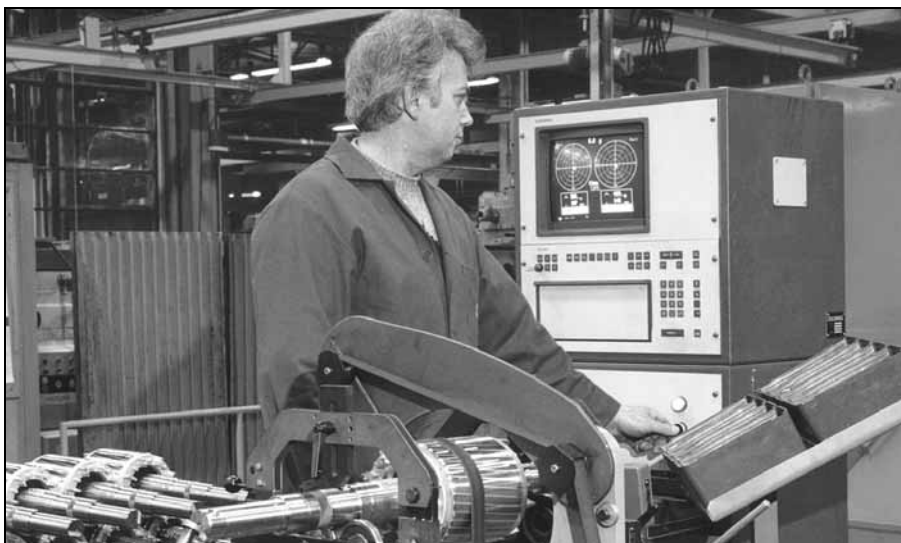

Asynchronous LSMV motors for speed variation General information

PAGES

F1 - Quality assurance 56

F2 - Standards and approvals 57 to 59

F3 - Designation 60



Asynchronous LSMV motors for speed variation General information

F1 - Quality commitment

LEROY-SOMER's quality management system is based on :

- control of procedures right from the initial sales offering until delivery to the customer, including design, manufacturing start-up and production.

- a total quality policy based on making continuous progress in improving operational procedures, involving all departments in the company in order to give customer satisfaction as regards delivery times, conformity and cost.

- indicators used to monitor procedure performance.

- corrective actions and advancements with tools such as FMECA, QFD, MAVP, MSP/MSQ and Hoshin type improvement workshops on flows, process re-engineering, plus Lean Manufacturing and Lean Office.

- annual surveys, opinion polls and regular visits to customers in order to ascertain and detect their expectations.

Personnel are trained and take part in the analyses and the actions for continuously improving the procedures.

LEROY-SOMER has entrusted the certification of its expertise to various international organisations.

Certification is granted by independent professional auditors, and recognises the high standards of the **company's quality assurance procedures**. All activities resulting in the final version of the machine have therefore received official **ISO 9001: 2000 certification from the DNV**. Similarly, our environmental approach has enabled us to obtain ISO 14001: 2004 certification.

Products for particular applications or those designed to operate in specific environments are also approved or certified by the following organisations: CETIM, LCIE, DNV, INERIS, EFECTIS, UL, BSRIA, TUV, CCC, GOST, which check their technical performance against the various standards or recommendations.



ISO 9001 : 2000





Asynchronous LSMV motors for speed variation General information

F2 - Standards and approvals

ORGANIZATION OF STANDARDS AUTHORITIES

International bodies

<p>Worldwide</p> 	<p>General standardization</p> <p>ISO International Standards Organisation</p> <div style="display: flex; justify-content: space-around;"> <div style="border: 1px solid black; padding: 2px; text-align: center;">TC Technical Committees</div> <div style="border: 1px solid black; padding: 2px; text-align: center;">SC Sub- Committees</div> <div style="border: 1px solid black; padding: 2px; text-align: center;">WG Working Groups</div> </div>	<p>Electronics and Electrotechnical Certification</p> <p>IEC International Electrotechnical Commission</p> <div style="display: flex; justify-content: space-around;"> <div style="border: 1px solid black; padding: 2px; text-align: center;">TC Technical Committees</div> <div style="border: 1px solid black; padding: 2px; text-align: center;">SC Sub- Committees</div> <div style="border: 1px solid black; padding: 2px; text-align: center;">WG Working Groups</div> </div>
<p>Europe</p> 	<p>ECS / CEN European Committee for Standardization</p> <p>ECISS European Committee for Iron and Steel Standards</p> <div style="border: 1px solid black; padding: 2px; text-align: center; margin: 10px auto; width: 100px;">TC Technical Committee</div>	<p>CENELEC European Committee for Electrotechnical Standardization</p> <div style="display: flex; justify-content: space-around; margin-top: 10px;"> <div style="border: 1px solid black; padding: 2px; text-align: center; width: 40px;">TC Technical Commit-</div> <div style="border: 1px solid black; padding: 2px; text-align: center; width: 40px;">SC Study Groups</div> <div style="border: 1px solid black; padding: 2px; text-align: center; width: 40px;">GAH Ad-hoc Groups</div> </div>

Country	Initials	Designation
AUSTRALIA	SAA	Standards Association of Australia
BELGIUM	IBN	Institut Belge de Normalisation
CIS (ex-USSR)	GOST	Gosudarstvennaya Komitet Standartov
DENMARK	DS	Dansk Standardiseringsraad
FINLAND	SFS	Suomen Standardisoimisliitto
FRANCE	AFNOR including UTE	Association Française de Normalisation including: Union Technique de l'Électricité
GERMANY	DIN/VDE	Verband Deutscher Elektrotechniker
GREAT BRITAIN	BSI	British Standards Institution
ITALY	IEC	Comitato Electrotecnico Italiano
JAPAN	JIS	Japanese Industrial Standard
NETHERLANDS	NNI	Nederlands Normalisatie - Instituut
NORWAY	NFS	Norges Standardiseringsforbund
SAUDI ARABIA	SASO	Saudi Arabian Standards Organization
SPAIN	UNE	Una Norma Española
SWEDEN	SIS	Standardiseringskommissionen I Sverige
SWITZERLAND	SEV or ASE	Schweizerischer Elektrotechnischer Verein
UNITED STATES	ANSI including NEMA	American National Standards Institute including: National Electrical Manufacturers



Asynchronous LSMV motors for speed variation General information

F2 - Standards and approvals

List of standards mentioned in this document

Reference		Date	International standards
IEC 60034-1	EN 60034-1	1999	Rotating electrical machines: assigned characteristics and operating characteristics.
IEC 60034-5	EN 60034-5	2000	Rotating electrical machines: classification of degrees of protection achieved for the housing of the rotating machine.
IEC 60034-6	EN 60034-6	1993	Rotating electrical machines (except traction): cooling methods.
IEC 60034-7	EN 60034-7	2000	Rotating electrical machines (except traction): symbols for the construction forms and mounting positions.
IEC 60034-8		2001	Rotating electrical machines: extremity marks and direction of rotation.
IEC 60034-9	EN 60034-9	1997	Rotating electrical machines: noise limits.
IEC 60034-12	EN 60034-12	1999	Starting characteristics for three-phase single speed cage induction motors on a supply voltage less than or equal to 660V.
IEC 60034-14	EN 60034-14	2004	Rotating electrical machines: mechanical vibrations for certain machines with a shaft height greater or equal to 56 mm. Measurements, evaluation and vibration limits.
IEC 60038		1999	Standardised voltages of the IEC.
IEC 60072-1		1991	Dimensions and range of powers for rotating electrical machines: designation of housings between 56mm and 400mm and of flanges between 55mm and 1080mm.
IEC 60085		1984	Thermal evaluation and classification of the electrical insulation.
IEC 60721-2-1		1987	Classification of natural environmental conditions. Temperature and humidity.
IEC 60892		1987	Effects of unbalanced voltages on the characteristics of asynchronous three-phase cage motors.
IEC 61000-2-10/11 et 2-2		1999	Electromagnetic compatibility (EMC): environment.
Guide 106 IEC		1989	Guide to the specification of environmental conditions for the fixing of the operating characteristics of materials.
ISO 281		2000	Bearings - basic dynamic loads and nominal lifetimes.
ISO 1680	EN 21680	1999	Acoustic - Test code for the measurement of air noise emitted by rotating electrical machines: methods of expertise for the free air conditions above a reflective plane.
ISO 8821		1999	Mechanical vibrations - Balancing. Conventions relating to shaft keys and added-on elements.
	EN 50102	1998	Degree of protection achieved by electrical housings against extreme mechanical impacts.

Asynchronous LSMV motors for speed variation General information

F2 - Standards and approvals

Approvals

Certain countries recommend or insist on approval from national organizations.

Approved products must carry the recognised mark on their identification plate.

Country	Initials	Organization
USA	UL	Underwriters Laboratories
CANADA	CSA	Canadian Standards Association
etc.		

Approvals for LEROY-SOMER motors (versions derived from standard construction):

Country	Initials	Certification N°	Application
CANADA	CSA	LR 57 008	Standard adapted range (see section § D2.2.3)
USA	UL or FUL	E 68554 SA 6704 E 206450	Impregnation systems Stator/rotor assemblies for sealed units Complete motors up to 160 frame size
SAUDI ARABIA	SASO		Standard range
FRANCE	LCIE INERIS	Various n ^{OS}	Sealing, shocks, safety

For specifically approved products, see the relevant documents.

International and national standard equivalents

International standards of reference		National standards				
IEC	Title (summary)	FRANCE	GERMANY	ENGLAND	ITALY	SWITZERLAND
60034-1	Assigned characteristics and operating characteristics	NFEN 60034-1 NFC 51-120 NFC 51-200	DIN/VDE O530	BS 4999	IEC 2.3.VI.	SEV ASE 3009
60034-2	Determination of losses and efficiencies	NFEN 60034-2	DIN/EN 60034-2	BS 4999-102		
60034-5	Classification of degrees of protection	NFEN 60034-5	DIN/EN 60034-5	BS EN 60034-5	UNEL B 1781	
60034-6	Cooling methods	NFEN 60034-6	DIN/EN 60034-6	BS EN 60034-6		
60034-7	Construction form and mounting positions	NFEN 60034-7	DIN/EN 60034-7	BS EN 60034-7		
60034-8	Extremity marks and direction of rotation	NFC 51 118	DIN/VDE 0530 Teil 8	BS 4999-108		
60034-9	Noise limits	NFEN 60034-9	DIN/EN 60034-9	BS EN 60034-9		
60034-12	Starting characteristics for single speed motors on a supply voltage less than or equal to 660 V	NFEN 60034-12	DIN/EN 60034-12	BS EN 60034-12		SEV ASE 3009-12
60034-14	Mechanical vibrations of machines with > 56 mm frame size	NFEN 60034-14	DIN/EN 60034-14	BS EN 60034-14		
60072-1	Dimensions and ranges of powers of machines with shaft heights between 56mm and 400mm and flanges between 55mm and 1080mm.	NFC 51 104 NFC 51 105	DIN 748 (-) DIN 42672 DIN 42673 DIN 42631 DIN 42676 DIN 42677	BS 4999		
60085	Thermal evaluation and classification of the electrical insulation	NFC 26206	DIN/EN 60085	BS 2757		SEV ASE 3584

Note: The tolerances of the DIN 748 do not conform to IEC 60072-1.

Asynchronous LSMV motors for speed variation General information

F3 - Designation



IP 55
CL.F - ΔT 80 K
MULTI-VOLTAGE

Order the desired material using the chart below.

Use the following titles for selection.

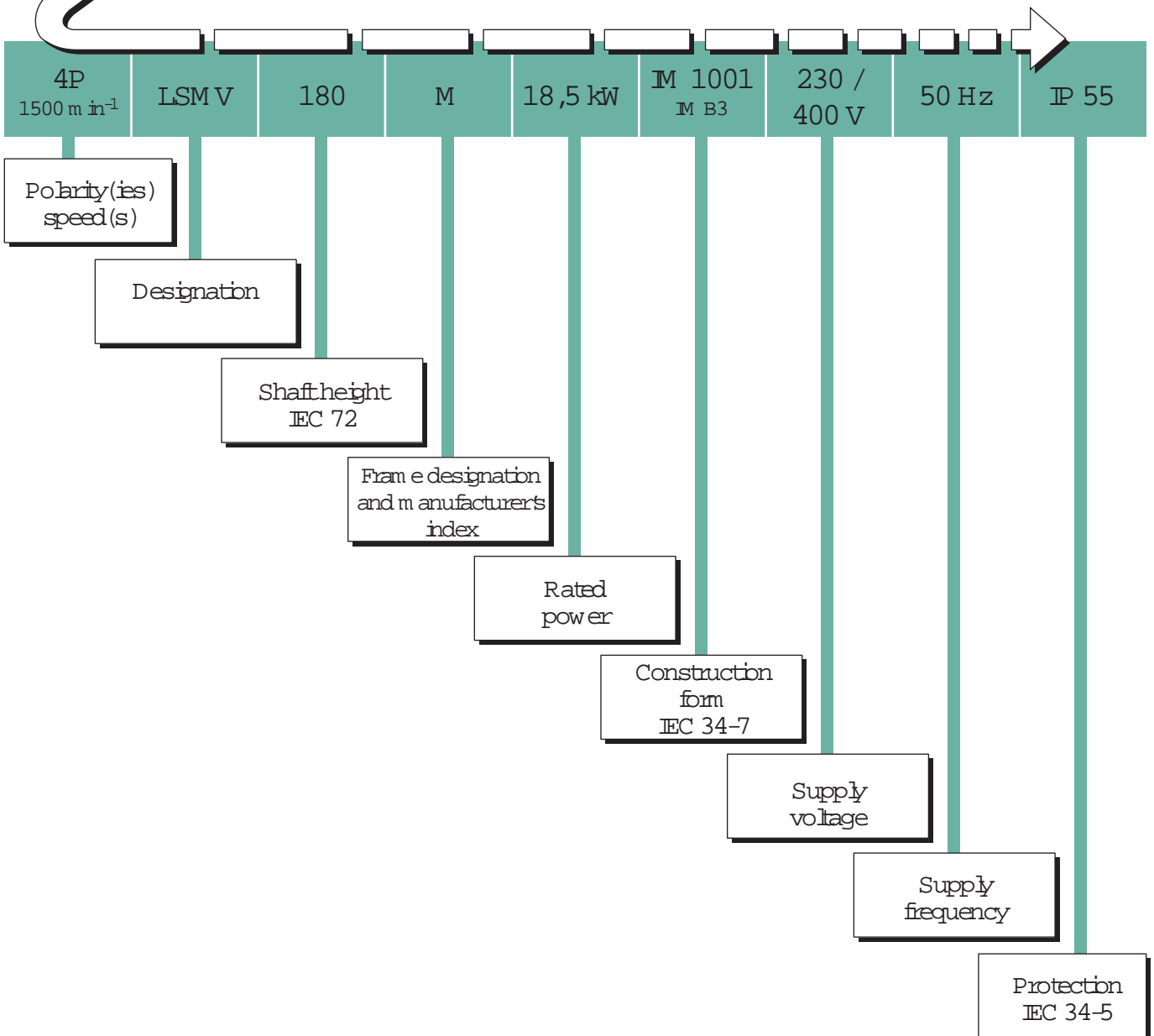

The products and materials presented in this catalogue can be subjected to technical, visual and operational evolution or modifications.
Under no circumstances is their description contractual.

Notes

Notes

Notes

I - SCOPE OF APPLICATION

These General Conditions of Sale ("GCS") shall apply to the sale of all products, components, software and services (referred to as "Products") proposed or sold by the Seller to the Client. Said GCS shall also apply to all quotation offers made by the Seller, and are an integral part of all orders. "Seller" is understood to mean all companies directly or indirectly controlled by LEROY-SOMER. As a complementary measure, orders are also subject to the latest version in force of the Inter-Union General Conditions of Sale for France of the F.I.E.E.C. (*Fédération des Industries Electriques, Electroniques et de Communication* [Federation of Electrical, Electronic and Communication Industries]), inasmuch as they are not contrary to the GCS.

The acceptance of the Seller's offers or quotations, or any order, entails the acceptance without reservation of these GCS and rules out all contrary provisions shown on all other documents and, in particular, on the Client's order forms and the Client's General Conditions of Purchase.

If the sale concerns castings, by way of derogation to Paragraph 1 above, said castings shall be subject to the latest version in force of the *Conditions Générales Contractuelles des Fonderies Européennes* [General Contractual Conditions of European Foundries]. **The Products and services sold pursuant to these GCS may under no circumstances be used for applications in the nuclear field, as such sales expressly fall under technical specifications and specific contracts that the Seller reserves the right to refuse.**

II - ORDERS

All orders, even those taken by the Seller's agents and representatives, and regardless of the transmission method, shall only bind the Seller after written acceptance thereby of the order.

The Seller reserves the option of modifying the characteristics of its Products without notice. However, the Client shall retain the possibility of specifying the characteristics on which its commitment is contingent. In the absence of any such express stipulation, the Client may not refuse delivery of new, modified Products.

The Seller may not be held liable for an unsatisfactory selection of Products if said selection results from conditions of use that are incomplete and/or mistaken, or not disclosed to the Seller by the Client. Except in the event of a stipulation to the contrary, the offers and quotations submitted by the Seller shall only be valid for thirty days as from the date on which they are drawn up.

Where the Products must comply with standards, specific regulations and/or be received by control and inspection agencies, the price request must be accompanied by the technical specification, all terms and conditions the Seller must comply with. Reference shall be made thereto on the quotation or offer. Approval and attendance costs shall always be borne by the Client.

III - PRICES

Tariffs are expressed exclusive of tax and may be revised without notice.

Prices are either deemed to be firm for the period of validity specified on the quotation, or subject to a revision formula attached to the offer and which specifies, according to the regulations, parameters pertaining to the materials, products, various services and salaries for which the indices are published in the B.O.C.C.P.F. (*Bulletin Officiel de la Concurrence, de la Consommation et de la Répression des Fraudes* [French Official Journal of Competition and Consumer Matters, and Anti-Fraud Measures]).

All additional costs, in particular approval costs, specific checks, etc., shall be invoiced in addition.

IV - DELIVERY

Sales are governed by the latest edition in force of the INCOTERMS published by the Internal Chamber of Commerce ("I.C.C. INCOTERMS").

The Products shall be dispatched according to the conditions stated on the order acknowledgement issued by the Seller for all orders of Products.

Except in the event of specific provisions, the prices correspond to Products that are made available in the Seller's factories, including basic packaging.

Except in the event of a provision to the contrary, the Products shall always be transported at the risk of the addressee. In all cases, it shall be the responsibility of the Client to make any claims to the carrier, within the delivery time and in the forms specified by law, concerning the state or number of parcels received, and to concomitantly provide the Seller with a copy of such declaration. Failure to comply with said procedure shall exempt the Seller from any liability. In any event, the Seller's liability may not exceed the amount of the indemnities received from its insurers.

If the provisions concerning transportation are amended by the Client subsequent to the acceptance of the order, the Seller reserves the right to invoice any supplemental costs that may result therefrom.

Except in the event of a contractual or statutory obligation to the contrary, packaging shall not be returnable.

In the event that a delivery of Products is delayed for a reason not attributable to the Seller, the Products stored on the Seller's premises shall be insured at the exclusive risk of the Client. Consideration for storage, costs will be invoiced at a rate of 1% (*one per cent*) of the total amount of the order, per week or partial week of storage, with no deductible or *de minimis* amount, as from the date of Products availability provided for in the contract. Upon expiration of a period of thirty days as from said date, the Seller may, at its discretion, either freely dispose of the Products and/or agree with the Client on a new delivery date for said Products, or invoice the Client in full for payment, according to the timeframes and amount provided for contractually. In any event, down payments shall inure to the Seller as indemnities, without prejudice to any other action the Seller may take.

V - DELIVERY TIME

The Seller shall only be bound by the delivery time mentioned on its order acknowledgement. Said delivery time shall only start to run as from the date of issuance of the order acknowledgement by the Seller, and subject to the fulfilment of the conditions provided for on the confirmation receipt, in particular receipt of the down payment for the order, notification of the opening of an operative irrevocable and confirmed documentary credit that complies in all respects to the Seller's request (*in particular regarding the amount, currency, validity and licence*), and the acceptance of the payment conditions accompanied by the implementation of any guarantees requested, etc.

Exceeding delivery time shall not grant the Client entitlement to damages and/or penalties.

Except in the event of a specific condition to the contrary, the Seller reserves the right to make partial deliveries.

Delivery times shall be interrupted by right and without the need for any judicial formalities, by any failure to pay or late payment by the Client.

VI - TESTS - QUALIFICATION

The Products manufactured by the Seller are checked and tested before leaving its factories. Clients may be present at said tests if specified on the order.

Specific tests and/or trials, as well as approval of Products, requested by the Client, whether carried out on the Client's premises or in the Seller's factories, on site, or by control and inspection agencies, must be specified on the order and are always at Client's expense.

Prototypes for Products specially developed or adapted for a Client must be qualified by the Client before serial production in order to ensure that it is compatible with the other components that make up its equipment, and that it is adapted to the intended use. Said qualification will also enable the Client to ensure that the Products comply with the technical specification. In this respect, the Client and Seller shall sign a Product Approval Form in two original, one of which shall be retained by the Client and one by the Seller.

In the event that the Client requires delivery without having firstly qualified the Products, said Products shall be delivered as they stand and shall always be deemed to be prototypes; the Client shall then be solely liable for using the Products or delivering them to its own clients. However, the Seller may also decide not to deliver the Products that have not received the Client's prior approval.

VII - PAYMENT CONDITIONS

All sales shall be deemed to be completed and payable at the Seller's registered office, without any possible derogation, regardless of the payment method, where the contract was concluded and where delivery was made.

Where the Client is located out of French territory, invoices shall be payable in cash upon receipt, or by a bank draft or a bill of exchange, within 30 (thirty) days net.

All early payment compared to the deadline fixed shall give right to a discount of 0.2% (*nought point two per cent*) per month, of the amount concerned of the invoice.

Except in the event of provisions to the contrary, where the Client is located outside of French Territory, invoices shall be payable in cash against remittance of shipping documents, or by irrevocable documentary credit confirmed by a first rate French bank, at Client's expense shall be understood to mean the funds being made available on the Seller's bank account and must imperatively be made in the invoicing currency.

Pursuant to French Law no. 2001-420 of 15 May 2001, failure to pay an invoice when due shall trigger, after service of formal notice that has remained without effect, payment to the Seller of a flat-rate penalty on the due date of the receivable, which shall be applied to amount inclusive of tax of monies owed if the invoice is liable to VAT (*Value Added Tax*), and the suspension of pending orders. Said penalty is equal to the European Central Bank Rate + 7 basis points.

The collection of said monies via litigation shall trigger an increase of 15% (*fifteen per cent*) of the amount claimed, with a minimum of Euros 500 exclusive of tax (*five hundred euros exclusive of tax*), with tax in addition if due.

Moreover, subject to compliance with the statutory provisions in force, in the event of total or partial failure to pay any invoice or instalment whatsoever, regardless of the payment method used, all amounts that remain owed to the Seller (*including its subsidiaries, affiliated or allied companies, whether French or foreign*) for all deliveries and services, regardless of the due date originally provided for, shall immediately become due.

Notwithstanding any specific payment conditions provided for between the parties, the Seller reserves the right to require, in the event of a decline in the Client's credit rating, a payment incident or bankruptcy of the Client :

- the payment in cash, before the Products leave the factory, for all orders currently being fulfilled,
- down payments to be made on all orders,
- alternative or different payment guarantees.

VIII - PAYABLE AND RECEIVABLE BALANCE

Except where prohibited by law, the Seller and the Client expressly agree to balance their payables and receivables arising from their trade relations, even if all conditions defined by law for legal balancing are not met.

For the application of said clause, the Seller shall mean any company of the LEROY-SOMER Group.

IX - TRANSFER OF RISK / RESERVE OF TITLE

Risk shall be transferred as soon as the Products are made available, according to the delivery conditions stipulated on the order acknowledgement.

The transfer to the Client of title shall take place after payment in full. In the event that the restitution of the Products delivered is claimed by the Seller, the Seller is entitled to retain any down payment as compensation.

Remittance of a bill that creates an obligation to pay (*bill of exchange or other*) shall not constitute payment and discharge. For as long as the price has not been paid in full, the Client is required to inform the Seller, within twenty-four hours, of the sequestration, requisition or confiscation of the Products for the benefit of a third party, and to take all protective measures to make known the Seller's property right in the event of action by creditors, and to cause such right to be respected.

X - CONFIDENTIALITY

Each of the parties undertakes to maintain the confidentiality of all technical, trade, financial or other information received from the other party, whether orally, in writing or by any other means of communication, when any order is negotiated and/or fulfilled. This confidentiality obligation shall apply throughout the period during which the order is fulfilled and for 5 (five) years subsequent to completion or cancellation thereof, regardless of the reasons therefor.

XI - INDUSTRIAL AND INTELLECTUAL PROPERTY

Data, studies, results, information or software, whether patentable or not obtained by the Seller when any order is fulfilled shall remain the exclusive property of the Seller.

With the exception of instruction and maintenance manuals, documents of any nature remitted to the Client shall remain the exclusive property of the Seller and must be returned to it upon request, even if the Client was invoiced for part of the cost of the study, and said documents may not be disclosed to third parties or used without the Seller's prior written agreement.

XII - CANCELLATION / TERMINATION

The Seller reserves the right to cancel or terminate immediately, at the Seller's discretion, by right and without the need for any judicial formalities, the contract in the event of failure to pay any portion whatsoever of the price, when due, or in the event of any breach of any of the Client's contractual obligations. Down payments and any amount already paid shall remain in the Seller's hands in the form of indemnities, without prejudice to the Seller's right to claim damages. In the event that the contract is cancelled, the Products must be returned to the Seller immediately, regardless of where the Products are located, at Client's expense and risk, under penalty of 10% (*ten per cent*) of the value thereof, per week's delay.

XIII - WARRANTY

The Seller warrants the Products against all operating defects caused by a material or manufacturing fault, for a period of twelve months as from the date on which the Products are made available, unless a different statutory provision subsequently applies, under the conditions defined below.

The warranty may only be triggered insofar as the Products have been stored, used and maintained in accordance with the Seller's instructions and manuals. The warranty does not apply where the defect results, in particular, from :

- inadequate monitoring, maintenance or storage,
- normal wear and tear on the Products,
- servicing or modification of the Products without the Seller's prior written authorisation,
- the use of the Products or use of the Products for a purpose other than that intended,
- faulty installation of the Products on the premises of the Client and/or the end user,
- failure by the Client to disclose the purpose or conditions of use of the Products,
- failure to use genuine spare parts,
- force majeure or any event that is beyond the control of the Seller.

In any case, the warranty is limited to the replacement or repair of the parts or Products deemed faulty by the Seller's technical departments. If the repair is entrusted to a third party, the repair shall only be carried out once the Seller has agreed to the quotation for the repair.

All Products returns must have been given the Seller's prior, written authorisation.

The Products to be repaired must be dispatched carriage paid, to the address given by the Seller. If the Products are not accepted under warranty, their return to the Client shall be invoiced to the Client or the end user.

This warranty shall apply to the Seller's Products that are made readily available and therefore does not cover the de-installation and re-installation of said Products in the equipment into which it is mounted.

Repair, modification or replacement of any part or Product during the warranty period may not result in the warranty period being extended.

The provisions of this article constitute the Seller's sole obligation concerning the warranty of the Products delivered.

XIV - LIABILITY

The Seller's liability is strictly limited to the obligations stipulated in these GCS and those expressly accepted by the Seller. All penalties and indemnities provided for therein constitute lump sum damages that include discharge for the Seller and are exclusive of any other penalty or indemnification.

With the exception of the Seller's gross negligence and the compensation of bodily injury, the Seller's liability shall be limited, in total, to the contractual amount, exclusive of tax, of the Product(s) that give(s) right to compensation.

The Seller may under no circumstances be required to indemnify consequential, indirect and / or punitive damages that the Client may use as the basis for a claim; as a result, the Seller may not be required to indemnify, in particular, production losses, operating losses or lost profit or, in general, any damage eligible for indemnification other than bodily injury or damage to property.

The Client undertakes to hold harmless the Seller and / or its insurers from any and all claims made by its insurers and/or any third party in a contractual relation with the Client, in excess of the limit and for the exclusions listed above.

XV - SPARE PARTS AND ACCESSORIES

Spare parts and accessories shall be supplied upon request, to the extent of their availability. Associated costs shall be invoiced in addition.

The Seller reserves the right to require a minimum quantity or invoicing amount per order.

XVI - WASTE MANAGEMENT

The Products that form the purpose of the sale does not fall within the scope of the European Directive 2002/96/EC (WEEE) dated January 27th, 2003, and all related legislation of Member States of the European Union that result therefrom, on the composition of electrical and electronic equipment and the disposal of waste from such equipment.

In accordance with Article L 541-2 of the French Environment Code, it is the responsibility of the waste holder to ensure the disposal thereof or to cause the disposal thereof at its own expense.

XVII - FORCE MAJEURE

With the exception of the Client's obligation to pay the monies owed to the Seller in respect of an order, the Client and Seller may not be held liable for the total or partial failure to perform their contractual obligations if such failure results from the occurrence of a force majeure. Delays or disturbances in production that totally or partially result from war (whether declared or not), terrorist act, strikes, riots, accidents, fires, floods, natural disasters, transportation delays, shortage of components or materials, governmental decision or action (including prohibition on import/export or the withdrawal of an import/export licence) shall, in particular, be deemed a force majeure.

If one of the parties is delayed or prevented from performing its obligations by reason of this Article for a period in excess of 180 consecutive days, each party may then terminate, by right and without any need for judicial formalities, the unperformed part of the order, by written notice to the other party, without liability. However, the Client shall be required to pay the price agreed pertaining to the Products already delivered on the date of termination.

XVIII - PROHIBITION ON UNLAWFUL PAYMENTS

The Client shall refrain from being engaged in any activity that would expose the Seller or any of its affiliates to a risk of penalties under laws and regulations of any relevant jurisdiction prohibiting improper payments, including but not limited to bribes or gifts of an obviously unreasonable amount, to any government or agency officials, to political parties or their officials or candidates for public office, or to any employee of any customer or supplier.

XIX - TRADE COMPLIANCE LAWS

The Client agrees that all applicable import, export control and sanctions laws, regulations, orders and requirements, as they may be amended from time to time, including without limitation those of the European Union, the United States of America, and the jurisdictions in which the Seller and the Client are established or from which Products may be supplied, and the requirements of any licences, authorisations, general licences or licence exceptions relating thereto ("Trade Compliance Laws") will apply to its receipt and use of Products, as well as related services and technology. In no event shall the Client use, transfer, release, export or re-export the Products, related services or technology in violation of Trade Compliance Laws.

Seller shall have no obligation to supply any Products, or services unless and until it has received any necessary licences or authorisations or has qualified for general licences or licence exceptions under Trade Compliance Laws.

If for any reason any such licences, authorisations or approvals are denied or revoked, or if there is a change in any Trade Compliance Laws that would prohibit Seller from fulfilling the contract, or would in the reasonable judgement of Seller otherwise expose Seller and/or Seller's Affiliate(s) to a risk of liability under Trade Compliance Laws, Seller shall be relieved without liability of all obligations under the contract.

XX - SEVERABILITY

All clauses and/or provisions of these General Conditions that are deemed or become null or void shall not cause the nullity or voidance of the contract, but solely the clause and/or provision concerned.

XXI - DISPUTES

THIS CONTRACT SHALL BE GOVERNED BY AND INTERPRETED IN ACCORDANCE WITH THE LAWS OF FRANCE.

ANY DISPUTE IN RELATION TO THE INTERPRETATION OR THE EXECUTION OF THIS CONTRACT NOT AMICABLY SETTLED BETWEEN THE PARTIES WITHIN A 30 DAY PERIOD, SHALL BE SETTLED BY THE COMPETENT COURT OF ANGOULÊME (FRANCE), EVEN IN THE CASE OF INTRODUCTION OF THIRD PARTIES OR THE INVOLVEMENT OF SEVERAL DEFENDANTS. HOWEVER, THE SUPPLIER RESERVES THE EXCLUSIVE RIGHT TO BRING THE DISPUTE TO THE COMPETENT COURTS OF THE SELLER OR THE CLIENT.



WORLD LEADER IN INDUSTRIAL DRIVE SYSTEMS

**ELECTRIC MOTORS - GEARBOXES - ELECTRONICS
ALTERNATORS - ASYNCHRONOUS GENERATORS - DC MACHINES**



**38 PRODUCTION UNITS
470 SALES & SERVICE CENTRES WORLDWIDE**

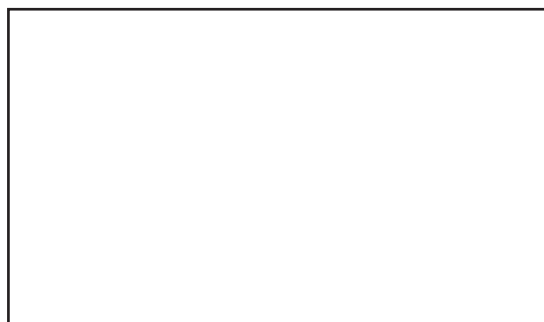

MOTEURS LEROY-SOMER 16015 ANGOULÊME CEDEX - FRANCE

338 567 258 RCS ANGOULÊME
S.A. au capital de 62 779 000 €

www.leroy-somer.com